

Amarre con patas - Mod. P

Código de producto: P-42-50

Fecha de creación de la hoja de datos: 26/05/26

Consulte el documento más actualizado en [haga clic](#)



DATOS TÉCNICOS

Mod.	P-42-50
------	---------

Amarre con patas - Mod. P

Código de producto: P-42-50

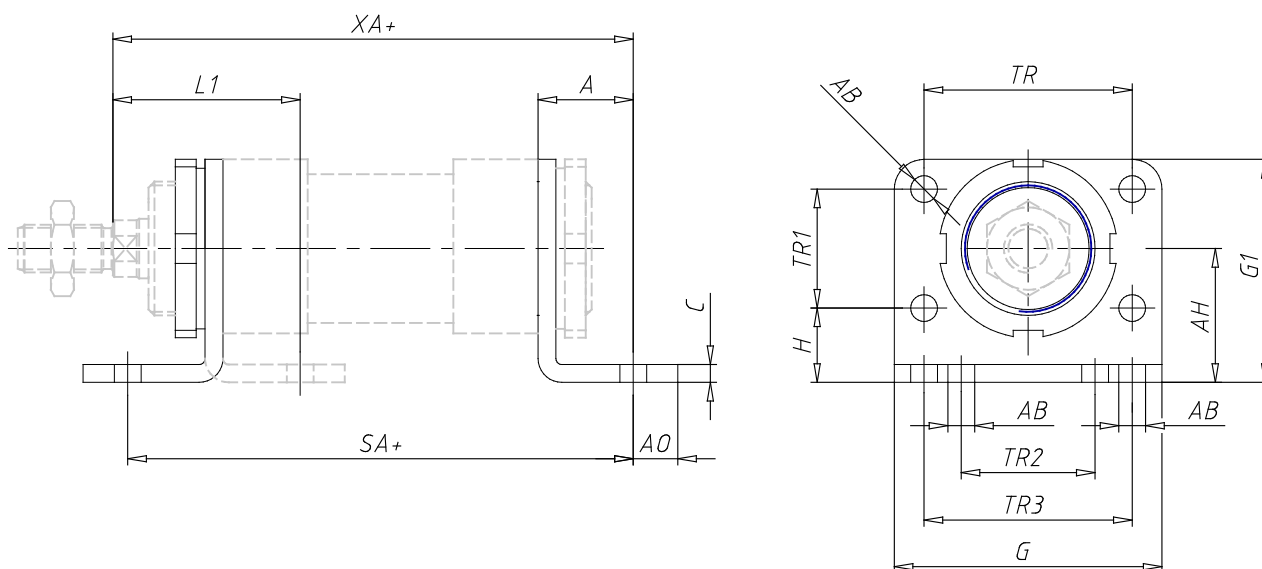

DIMENSIONES

L1 (mm)	63
SA (mm)	170
XA (mm)	175
A (mm)	32
AB (mm)	9
AO (mm)	15
AH (mm)	45
C (mm)	6
G (mm)	90
G1 (mm)	75
TR (mm)	70
TR1 (mm)	40
TR2 (mm)	45
TR3 (mm)	70
H (mm)	25