

Vérins cylindriques - Série 27

Code de produit: 27M2A20A0025

Date de création de la fiche technique : 21/05/26

Vérifiez le document le plus récent en ligne [cliquez ici](#)



■ DONNÉES TECHNIQUES

Série	27
Diamètre (mm)	20
Version	M = Alimentation latérale pour fixation charnière arrière
Fonctionnement	2 = Double effet
Matériaux	A = tige inox
Construction	A = standard
Course (mm)	25
Options de joint	= standard
Longueur de la tige (mm)	0
Certifications	= standard

Vérins cylindriques - Série 27

Code de produit: 27M2A20A0025

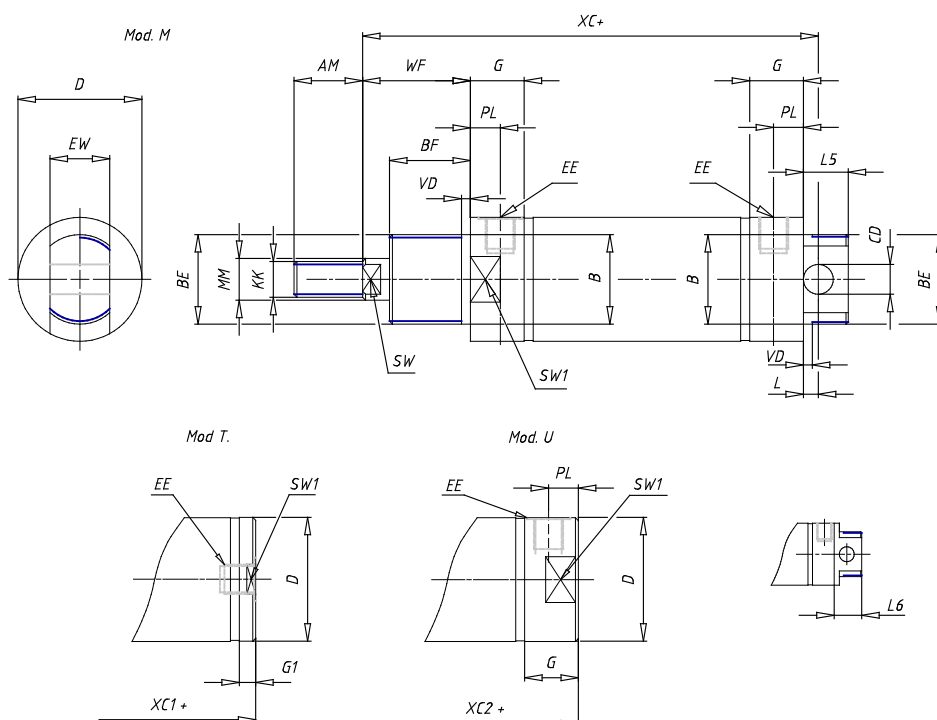

DIMENSIONS

AM (mm)	14
Ø B (mm)	16
BF (mm)	12
BE	M16x1.5
Ø CD (mm)	6
Ø D (mm)	21.5
EE	G1/8
EW (mm)	12
G (mm)	15.5
G1 (mm)	8.0
KK	M8x1.25
L (mm)	7
Ø MM (mm)	8
L5 (mm)	13
L6 (mm)	0
PL (mm)	9
SW (mm)	7
VD (mm)	3
WF (mm)	17.0
XC (mm)	77.0
XC1 (mm)	62.5
XC2 (mm)	70.8
SW1 (mm)	19

BG (mm)	0
BG1 (mm)	0.0
FB	0
RT	0
Ø RT1 (mm)	0
TC (mm)	0
TF (mm)	0.0