

Kit de fixation - Mod. 43N-40

Code de produit: 43N-40-40

Date de création de la fiche technique : 21/05/26

Vérifiez le document le plus récent en ligne [cliquez ici](#)

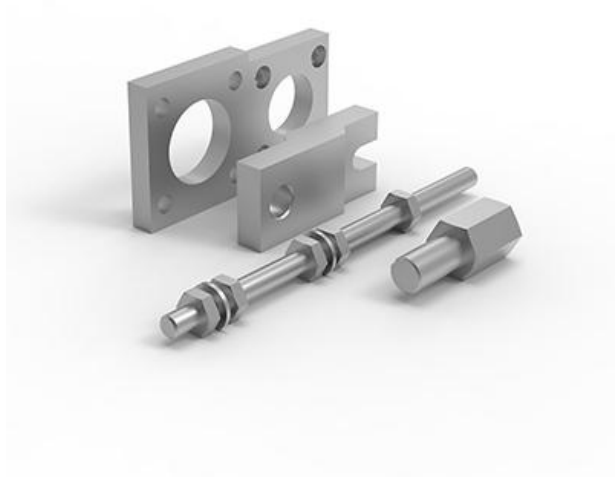

■ DONNÉES TECHNIQUES

Mod.	43N-40-40
------	-----------

Kit de fixation - Mod. 43N-40

Code de produit: 43N-40-40

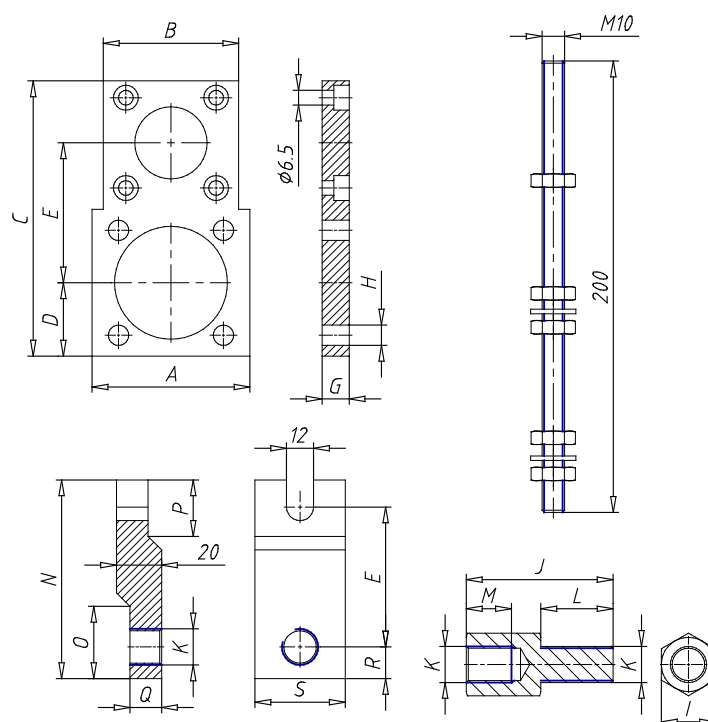

DIMENSIONS

A (mm)	60
B (mm)	0
C (mm)	110
D (mm)	27
E (mm)	56
F (mm)	0
G (mm)	12
H (mm)	7
I (mm)	19
J (mm)	47
K	M12x1.25
L (mm)	24
M (mm)	14
N (mm)	80
O (mm)	25
P (mm)	25
Q (mm)	14
R (mm)	12
S (mm)	40