

Kit de fixation - Mod. 43N-40

Code de produit: 43N-40-63

Date de création de la fiche technique : 21/05/26

Vérifiez le document le plus récent en ligne [cliquez ici](#)

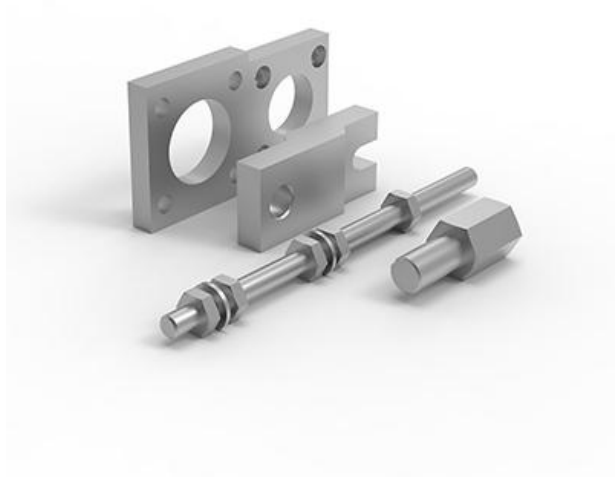

■ DONNÉES TECHNIQUES

Mod.	43N-40-63
------	-----------

Kit de fixation - Mod. 43N-40

Code de produit: 43N-40-63

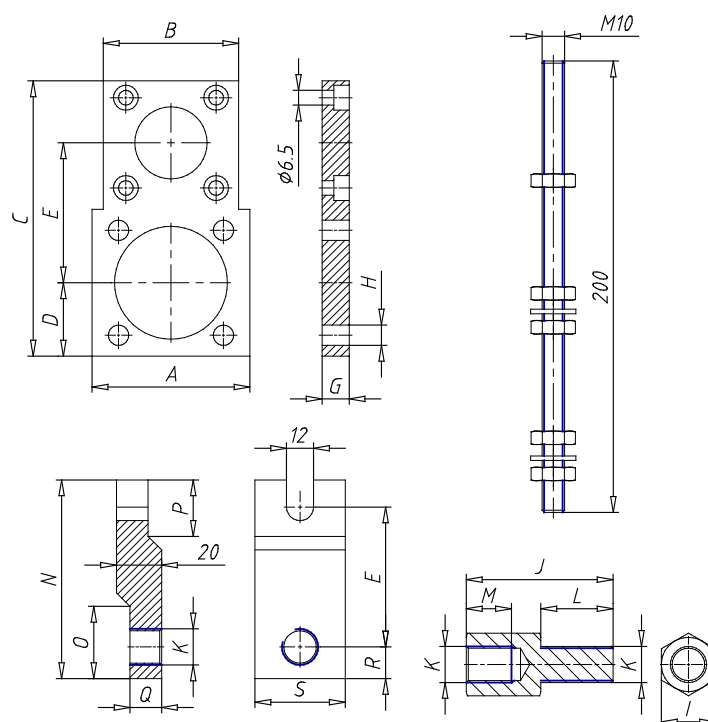

DIMENSIONS

A (mm)	80
B (mm)	60
C (mm)	132
D (mm)	38
E (mm)	67
F (mm)	57
G (mm)	20
H (mm)	9
I (mm)	24
J (mm)	65
K	M16x1.5
L (mm)	32
M (mm)	20
N (mm)	93
O (mm)	32
P (mm)	25
Q (mm)	14
R (mm)	14
S (mm)	40