

Unités de guidage anti-rotation - Série 45

Code de produit: 45NHB020A0050

Date de création de la fiche technique : 22/05/26

Vérifiez le document le plus récent en ligne [cliquez ici](#)



■ DONNÉES TECHNIQUES

Série	45
Version	N = standard
Fonctionnement	HB = Guide à billes en "H"
Diamètre (mm)	20
Matériaux	A = Corps aluminium anodisé, colonnes acier dur C50
Course (mm)	50

Unités de guidage anti-rotation - Série 45

Code de produit: 45NHB020A0050

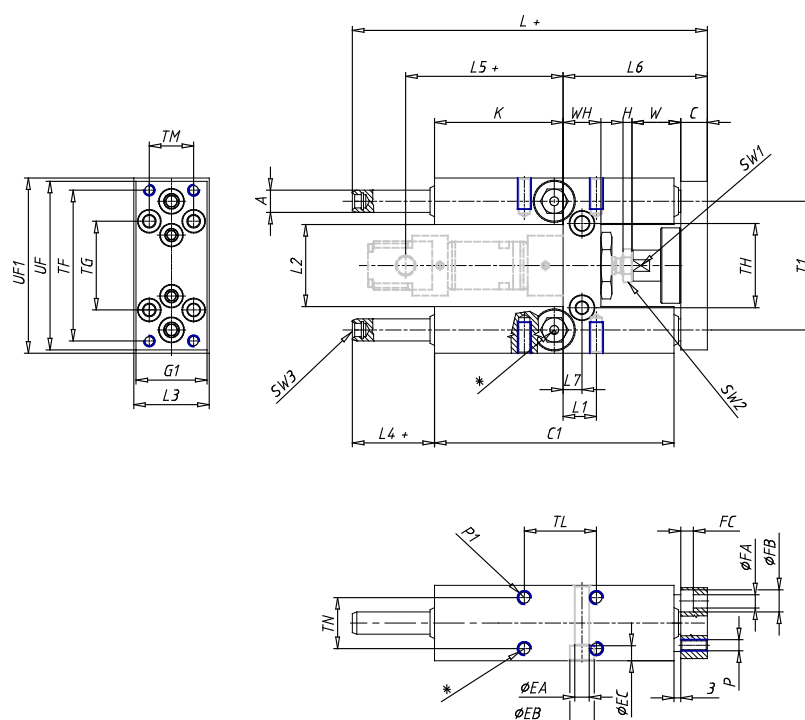

DIMENSIONS

TF (mm)	68
TG (mm)	40.0
TH (mm)	38.0
TI (mm)	58
TM (mm)	20
TL (mm)	32.5
TN (mm)	23
UF1 (mm)	79
UF (mm)	76
G1 (mm)	32
A (mm)	10
WH (mm)	17
C1 (mm)	108
H (mm)	4
W (mm)	22
C (mm)	12
K (mm)	58
L (mm)	160.0
L1 (mm)	15
L2 (mm)	37.0
L3 (mm)	34
L4 (mm)	37
L5 (mm)	71.0

L6 (mm)	65.0
L7 (mm)	8.5
L8 (mm)	0
P	M5
P1	M6
T (mm)	14
EA (mm)	6.5
EB (mm)	11
EC (mm)	6.8
FA (mm)	5.5
FB (mm)	10.0
FC (mm)	5.7
SW1 (mm)	13
SW2 (mm)	13
SW3 (mm)	4