

## Unités de guidage anti-rotation - Série 45

Code de produit: 45NHB020A0080

Date de création de la fiche technique : 22/05/26

Vérifiez le document le plus récent en ligne [cliquez ici](#)



### ■ DONNÉES TECHNIQUES

<b>Série</b>	45
<b>Version</b>	N = standard
<b>Fonctionnement</b>	HB = Guide à billes en "H"
<b>Diamètre (mm)</b>	20
<b>Matériaux</b>	A = Corps aluminium anodisé, colonnes acier dur C50
<b>Course (mm)</b>	80

## Unités de guidage anti-rotation - Série 45

Code de produit: 45NHB020A0080

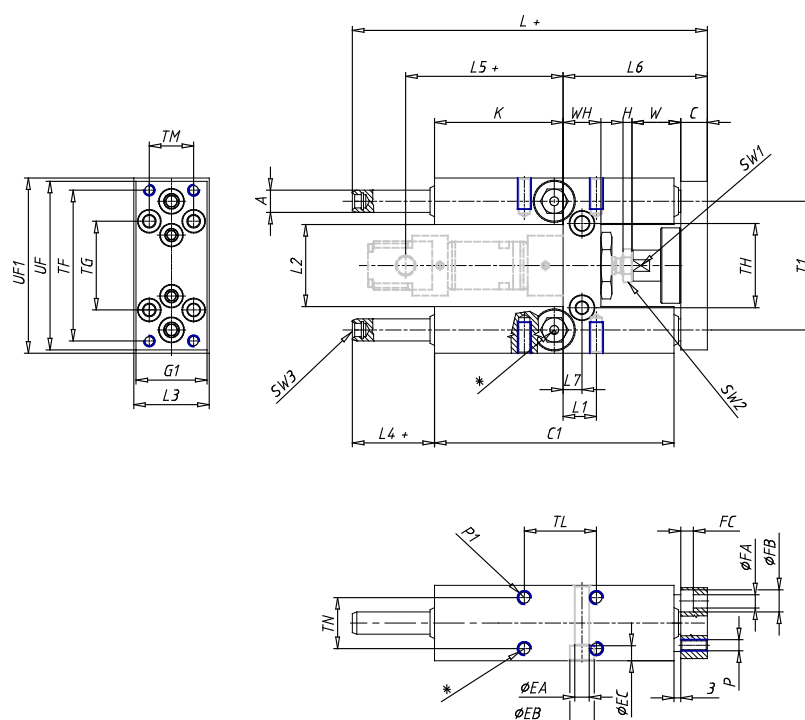

### DIMENSIONS

TF (mm)	68
TG (mm)	40.0
TH (mm)	38.0
TI (mm)	58
TM (mm)	20
TL (mm)	32.5
TN (mm)	23
UF1 (mm)	79
UF (mm)	76
G1 (mm)	32
A (mm)	10
WH (mm)	17
C1 (mm)	108
H (mm)	4
W (mm)	22
C (mm)	12
K (mm)	58
L (mm)	160.0
L1 (mm)	15
L2 (mm)	37.0
L3 (mm)	34
L4 (mm)	37
L5 (mm)	71.0

L6 (mm)	65.0
L7 (mm)	8.5
L8 (mm)	0
P	M5
P1	M6
T (mm)	14
EA (mm)	6.5
EB (mm)	11
EC (mm)	6.8
FA (mm)	5.5
FB (mm)	10.0
FC (mm)	5.7
SW1 (mm)	13
SW2 (mm)	13
SW3 (mm)	4