

## Axes électromécaniques entraînés par courroie - Série 5E-TBL

Code de produit: 5ES050TBL0150AS1

Date de création de la fiche technique : 22/05/26

Vérifiez le document le plus récent en ligne [cliquez ici](#)



### ■ DONNÉES TECHNIQUES

<b>Série</b>	5E
<b>Profile</b>	S = section carrée
<b>Taille</b>	050
<b>Transmission</b>	TBL = courroie dentée
<b>Version</b>	A = axe standard
<b>Type de chariot</b>	S= standard
<b>Nombre de chariot</b>	1 = 1 curseur
<b>CL (mm)</b>	0
<b>Course (mm)</b>	150

## Axes électromécaniques entraînés par courroie - Série 5E-TBL

Code de produit: 5ES050TBL0150AS1

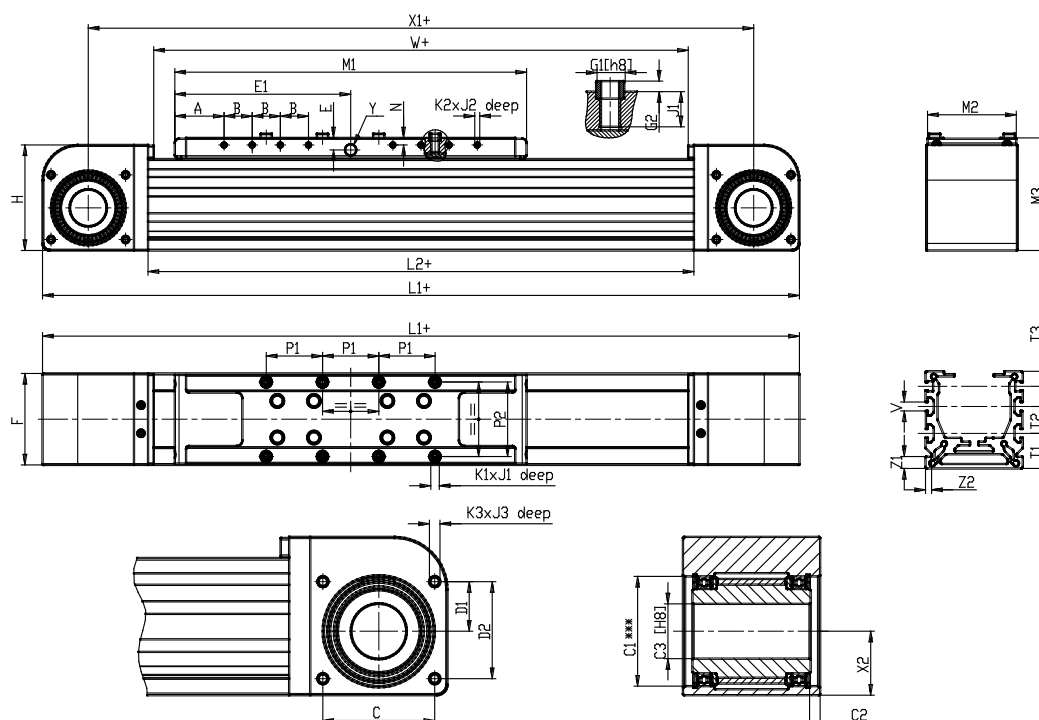

### DIMENSIONS

A (mm)	32.5
B (mm)	15
C (mm)	37
C1 (mm)	37
C2 (mm)	4.5
C3 (mm)	20
C4 (mm)	25
C5 (mm)	46
D1 (mm)	17.0
D2 (mm)	32.0
E (mm)	8.5
E1 (mm)	100.0
E2 (mm)	62
F (mm)	50
F4 (mm)	2
Ø G1 (mm)	6
G2 (mm)	2
H (mm)	60
L1 (mm)	354
L2 (mm)	238
M1 (mm)	200
M2 (mm)	48
M3 (mm)	65

M4 (mm)	180
N (mm)	5
P1 (mm)	30
P2 (mm)	40
P3 (mm)	23
P4 (mm)	20.0
K1	M4
J1 (mm)	7
K2	M3
J2 (mm)	5.0
K3	M4
J3 (mm)	8
T1 (mm)	20.0
T2 (mm)	0.0
T3 (mm)	10
V (mm)	6
Y	**
X1 (mm)	304
X2 (mm)	21.8
W (mm)	230
Z1 (mm)	8
Z2 (mm)	4
U (mm)	21.8