

Mod. C6510 - Raccords Série 6000

Code de produit: C6510 10-1/4

Date de création de la fiche technique : 22/05/26

Vérifiez le document le plus récent en ligne [cliquez ici](#)



■ DONNÉES TECHNIQUES

Mod.	C6510 10-1/4
------	--------------

Mod. C6510 - Raccords Série 6000

Code de produit: C6510 10-1/4

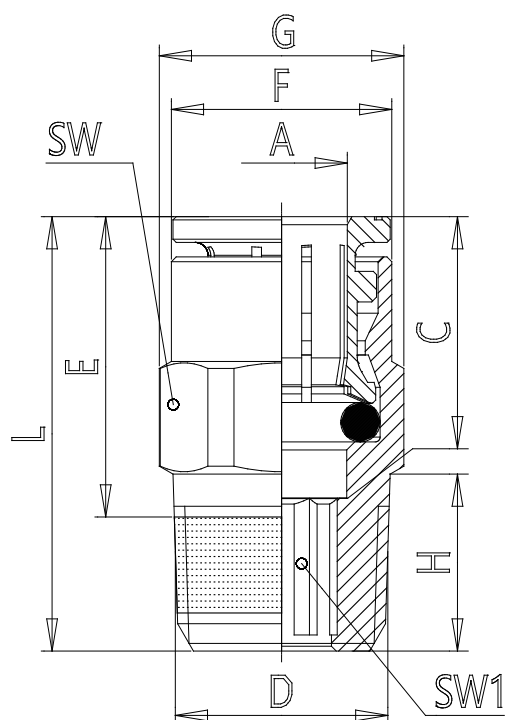

DIMENSIONS

A (mm)	10
D (mm)	R1/4
C (mm)	20.2
(mm)	24.0
F (mm)	15.4
G (mm)	18.5
H (mm)	11.0
L (mm)	33.0
SW (mm)	17
SW1 (mm)	7.0
Poids (g)	28