

Mod. C6510 - Raccords Série 6000

Code de produit: C6510 8-3/8

Date de création de la fiche technique : 22/05/26

Vérifiez le document le plus récent en ligne [cliquez ici](#)



■ DONNÉES TECHNIQUES

Mod.	C6510 8-3/8
------	-------------

Mod. C6510 - Raccords Série 6000

Code de produit: C6510 8-3/8

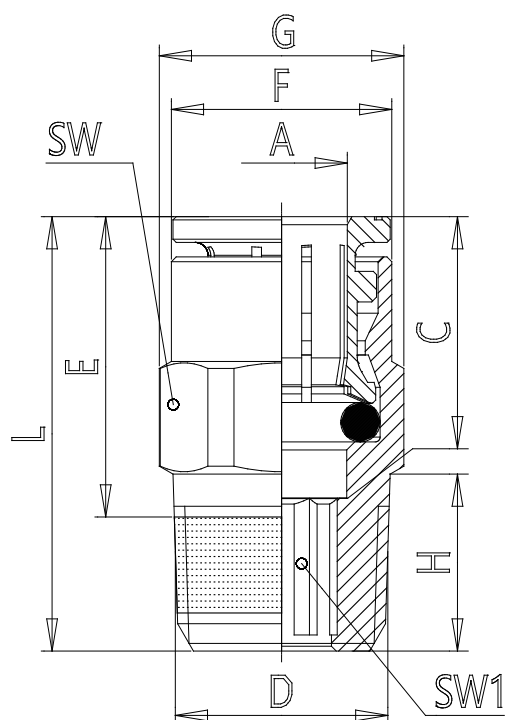

DIMENSIONS

A (mm)	8
D (mm)	R3/8
C (mm)	17.5
(mm)	18.0
F (mm)	13.7
G (mm)	20.5
H (mm)	11.5
L (mm)	27.5
SW (mm)	19
SW1 (mm)	6.0
Poids (g)	29