

## Charnière flottante - Mod. CF-50

Code de produit: CF-50-25

Date de création de la fiche technique : 22/05/26

Vérifiez le document le plus récent en ligne [cliquez ici](#)



### ■ DONNÉES TECHNIQUES

Mod.	CF-50-25
------	----------

## Charnière flottante - Mod. CF-50

Code de produit: CF-50-25

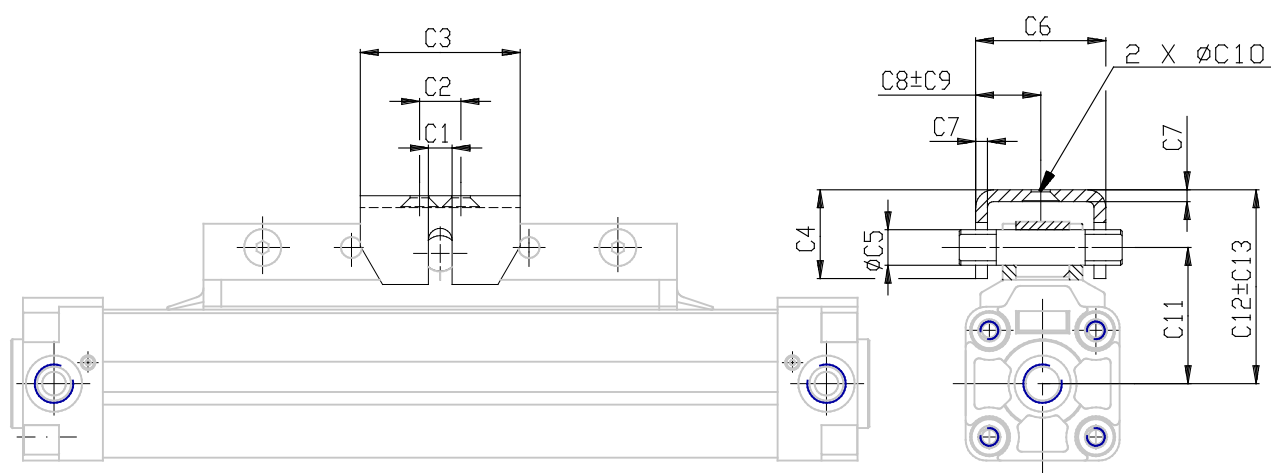

### DIMENSIONS

<b>C1 (mm)</b>	6.0
<b>C2 (mm)</b>	16
<b>C3 (mm)</b>	40.8
<b>C4 (mm)</b>	22.9
<b>C5 (mm)</b>	7.9
<b>C6 (mm)</b>	31.5
<b>C7 (mm)</b>	3.0
<b>C8 (mm)</b>	15.8
<b>C9 (mm)</b>	1.2
<b>C10 (mm)</b>	5.6
<b>C11 (mm)</b>	38
<b>C12 (mm)</b>	55.4
<b>C13 (mm)</b>	4.5