

## Mod. G7622 - Raccords Série 7000 - Automatisation

A( title=" ()", format="" ),D( title=" ()", format="" ),E( title=" ()", format="" ),G( title=" ()", format="" ),H( title=" ()", format="" )

Date de création de la fiche technique : 22/05/26

Vérifiez le document le plus récent en ligne [cliquez ici](#)



### ■ DONNÉES TECHNIQUES

Mod.	G7622 6-1/8
------	-------------

## Mod. G7622 - Raccords Série 7000 - Automatisation

A( title=" ( )", format="" ),D( title=" ( )", format="" ),E( title=" ( )", format="" ),G( title=" ( )", format="" ),H( title=" ( )", format="" )

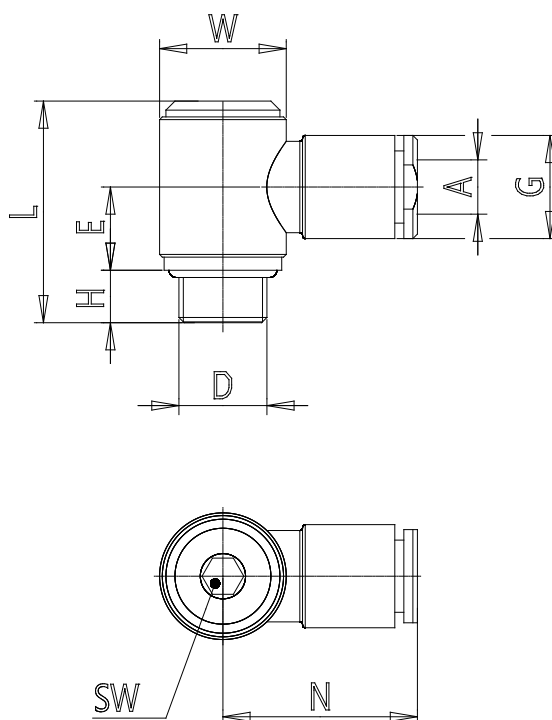

### DIMENSIONS

<b>A (mm)</b>	6
<b>D</b>	G1/8
<b>E (mm)</b>	10.0
<b>G (mm)</b>	11.4
<b>H (mm)</b>	5
<b>L (mm)</b>	24.5
<b>N (mm)</b>	21.5
<b>W (mm)</b>	14.0
<b>SW (mm)</b>	4.0
<b>Poids (g)</b>	12