

Mod. ND6430 - Raccords en pouces de la série ND6000

Code de produit: ND6430 04-04

Date de création de la fiche technique : 22/05/26

Vérifiez le document le plus récent en ligne [cliquez ici](#)



■ DONNÉES TECHNIQUES

Mod.	ND6430 04-04
------	--------------

Mod. ND6430 - Raccords en pouces de la série ND6000

Code de produit: ND6430 04-04

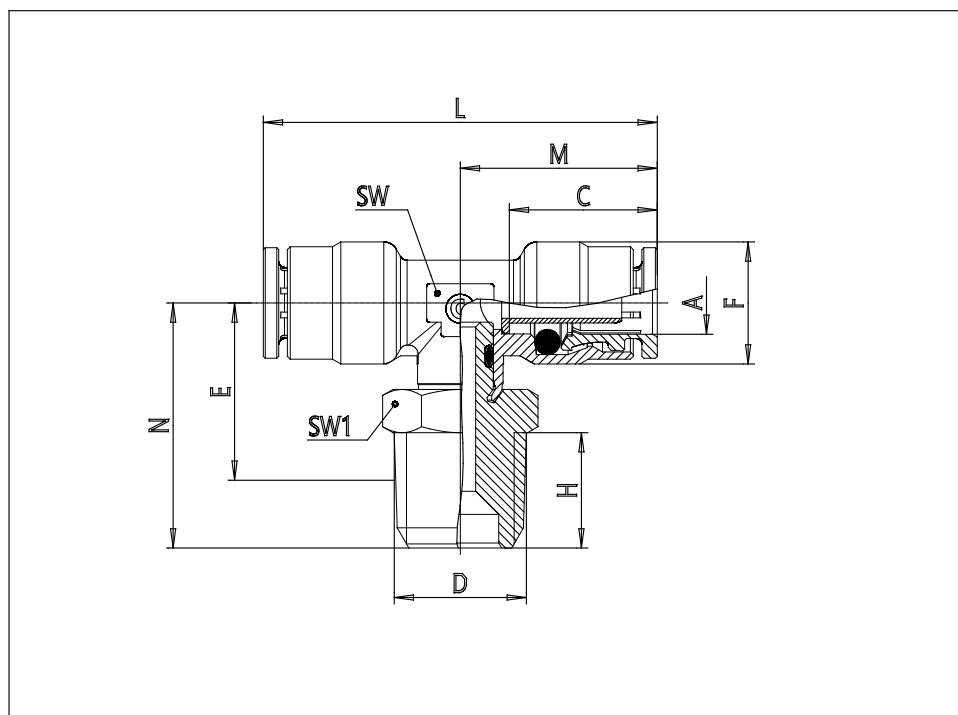

DIMENSIONS

A (INCH)	1/4
NPTF (INCH)	1/4
C (INCH)	0.606
F (INCH)	0.500
E (INCH)	0.709
H (INCH)	0.472
M (INCH)	0.807
L (INCH)	1.614
N (INCH)	1.004
SW (INCH)	0.354
SW1 (INCH)	0.551