

Mod. X6432 - Raccords série X6000

Code de produit: X6432 6-1/4

Date de création de la fiche technique : 22/05/26

Vérifiez le document le plus récent en ligne [cliquez ici](#)



■ DONNÉES TECHNIQUES

Mod.	X6432 6-1/4
------	-------------

Mod. X6432 - Raccords série X6000

Code de produit: X6432 6-1/4

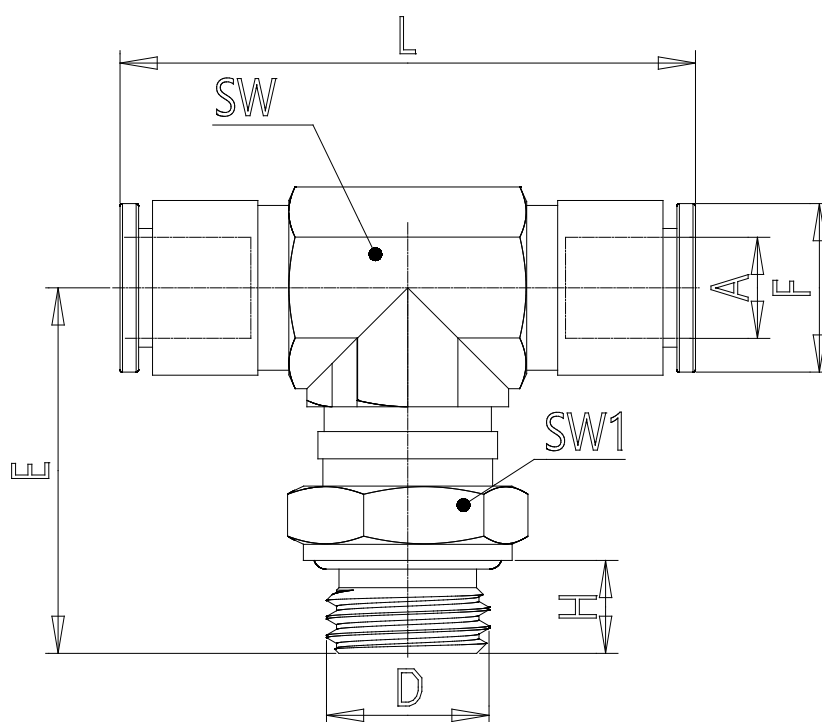

DIMENSIONS

A (mm)	6
D	G1/4
E (mm)	28.0
F (mm)	12.4
H (mm)	7.5
L (mm)	44.0
SW (mm)	12
SW1 (mm)	17