

Mod. X6432 - Raccords série X6000

Code de produit: X6432 8-1/8

Date de création de la fiche technique : 22/05/26

Vérifiez le document le plus récent en ligne [cliquez ici](#)



■ DONNÉES TECHNIQUES

Mod.	X6432 8-1/8
------	-------------

Mod. X6432 - Raccords série X6000

Code de produit: X6432 8-1/8

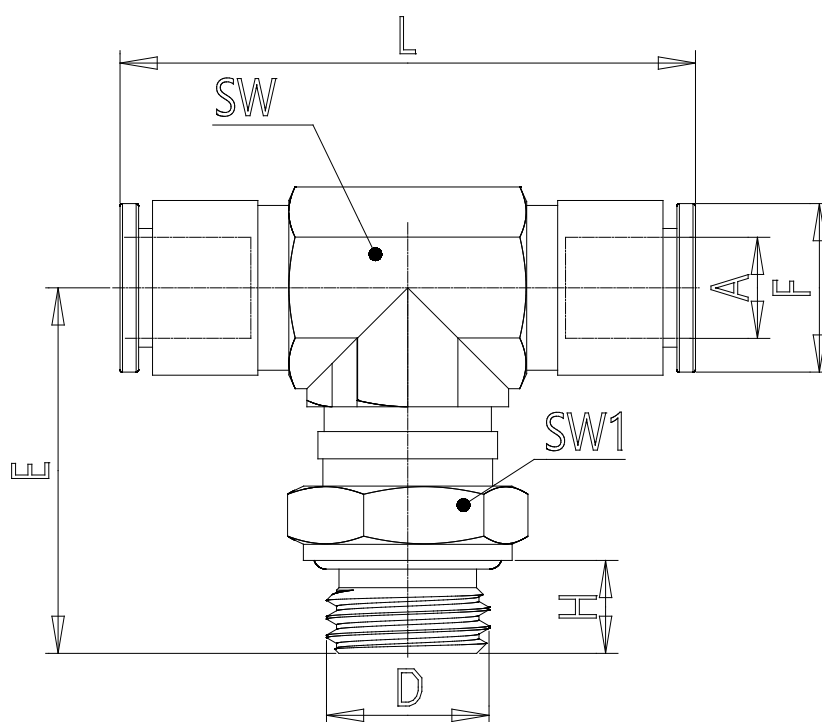

DIMENSIONS

A (mm)	8
D	G1/8
E (mm)	27.0
F (mm)	14.0
H (mm)	5.8
L (mm)	46.4
SW (mm)	14
SW1 (mm)	14