

## Mod. X6520 - Raccords série X6000

Code de produit: X6520 8-1/8

Date de création de la fiche technique : 21/05/26

Vérifiez le document le plus récent en ligne [cliquez ici](#)



### ■ DONNÉES TECHNIQUES

Mod.	X6520 8-1/8
------	-------------

## Mod. X6520 - Raccords série X6000

Code de produit: X6520 8-1/8

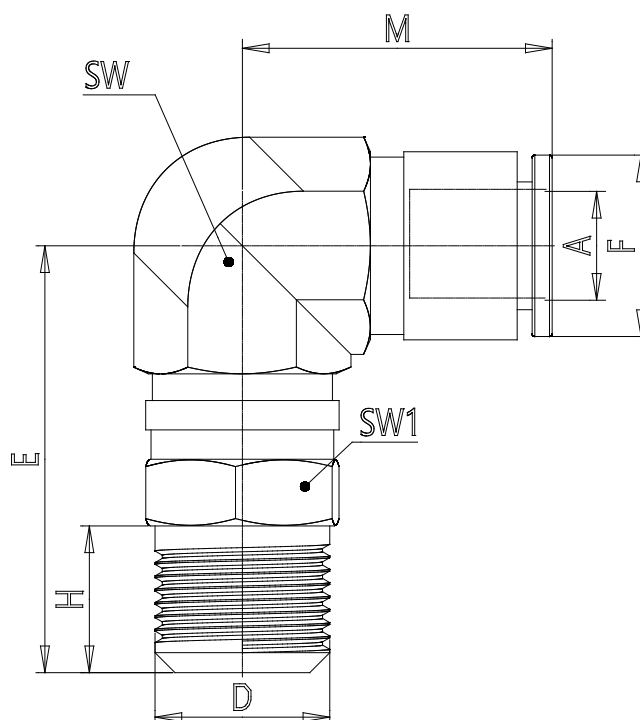

### DIMENSIONS

<b>A (mm)</b>	8
<b>D</b>	R1/8
<b>E (mm)</b>	27.8
<b>F (mm)</b>	14.0
<b>H (mm)</b>	7.5
<b>M (mm)</b>	23.2
<b>SW (mm)</b>	14
<b>SW1 (mm)</b>	14