

Accessori di montaggio - Mod. C-CGP

Codice prodotto: C-CGP-25

Data di creazione del data sheet: 14/05/26 16.54

Verifica il documento più aggiornato online [clicca qui](#)



SCHEDA TECNICA

Mod. (mm)	C-CGP-25
-----------	----------

Accessori di montaggio - Mod. C-CGP

Codice prodotto: C-CGP-25

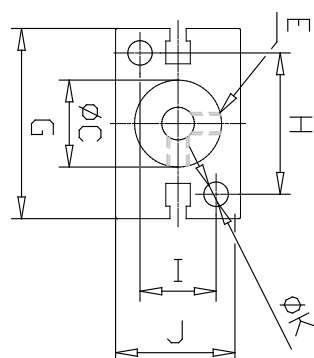
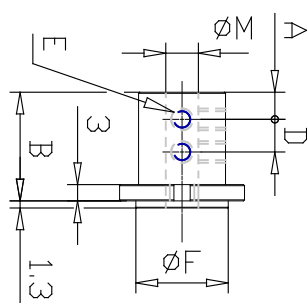

DIMENSIONI

A (mm)	8
B (mm)	30.5
C (mm)	25
D (mm)	10
E	M4
F (mm)	26
G (mm)	53
H (mm)	40
I (mm)	20
J (mm)	33
K (mm)	6.6
M (mm)	10