

Giunto compensatore - Mod. CF-50

Codice prodotto: CF-50-25

Data di creazione del data sheet: 15/05/26 11.33

Verifica il documento più aggiornato online [clicca qui](#)



SCHEDA TECNICA

Mod.	CF-50-25
------	----------

Giunto compensatore - Mod. CF-50

Codice prodotto: CF-50-25

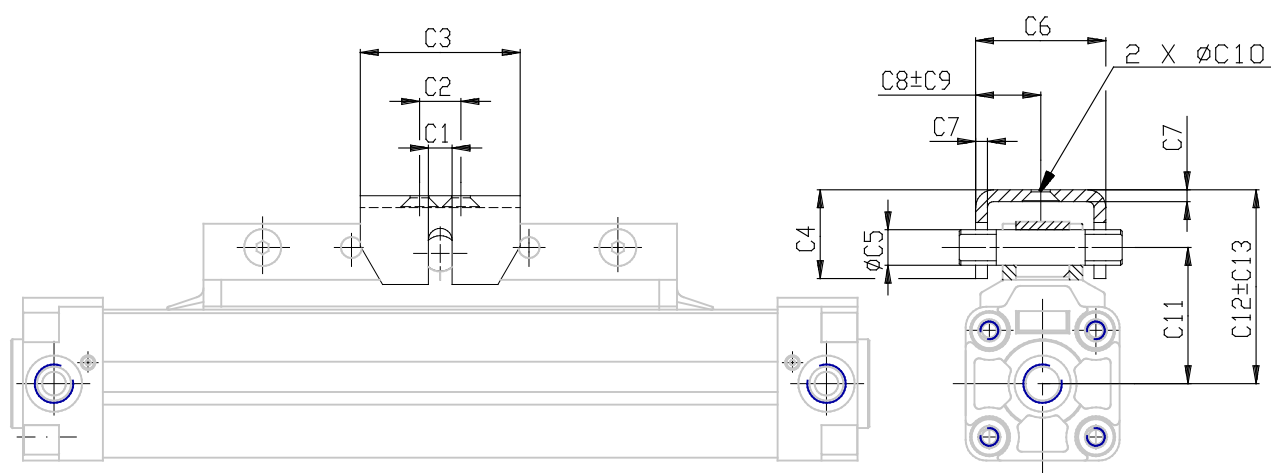

DIMENSIONI

C1 (mm)	6.0
C2 (mm)	16
C3 (mm)	40.8
C4 (mm)	22.9
C5 (mm)	7.9
C6 (mm)	31.5
C7 (mm)	3.0
C8 (mm)	15.8
C9 (mm)	1.2
C10 (mm)	5.6
C11 (mm)	38
C12 (mm)	55.4
C13 (mm)	4.5