

Sottobase - Serie CP-CPN

Codice prodotto: CP-S7

Data di creazione del data sheet: 15/05/26 16.20

Verifica il documento più aggiornato online [clicca qui](#)



SCHEDA TECNICA

Mod.	CP-S7
------	-------

Sottobase - Serie CP-CPN

Codice prodotto: CP-S7

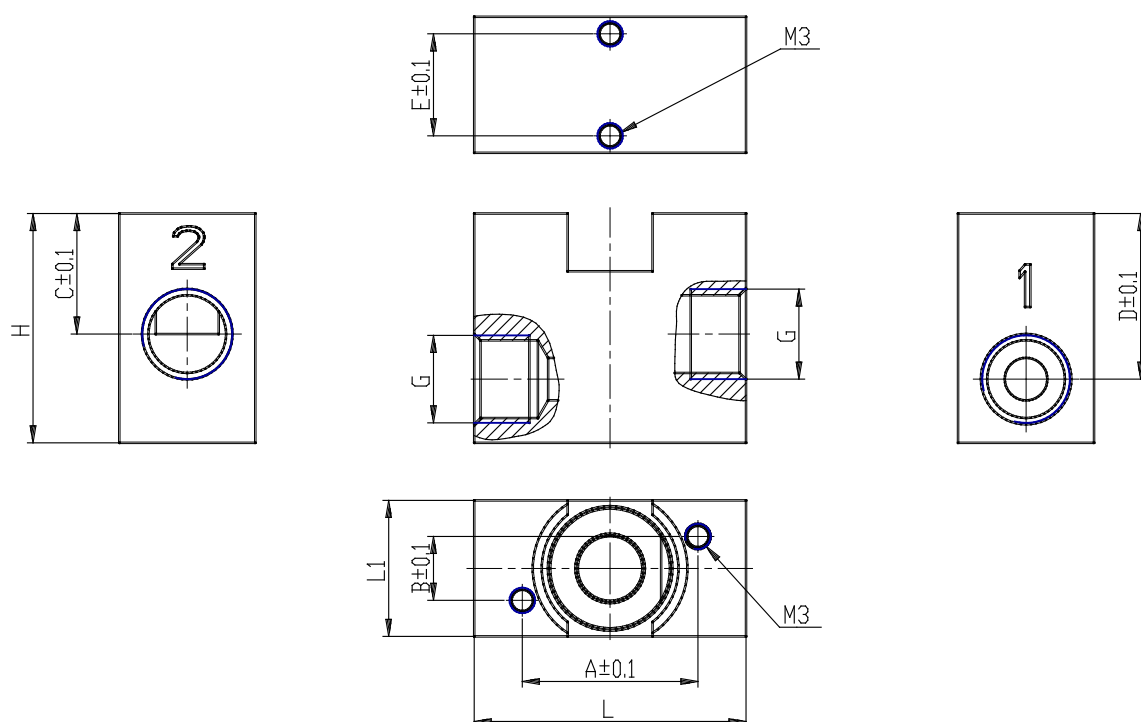

DIMENSIONI

A (mm)	25.20
B (mm)	8.00
C (mm)	14.0
D (mm)	22.5
E (mm)	15
G (mm)	1/4 G
H (mm)	31.5
L (mm)	45
L1 (mm)	22