

Ancoraggio a cerniera intermedia - Mod. F

Codice prodotto: F-32

Data di creazione del data sheet: 13/05/26 14.59

Verifica il documento più aggiornato online [clicca qui](#)

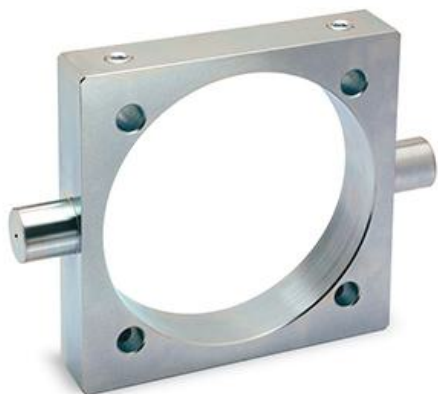

SCHEDA TECNICA

Mod.	F-32
------	------

Ancoraggio a cerniera intermedia - Mod. F

Codice prodotto: F-32

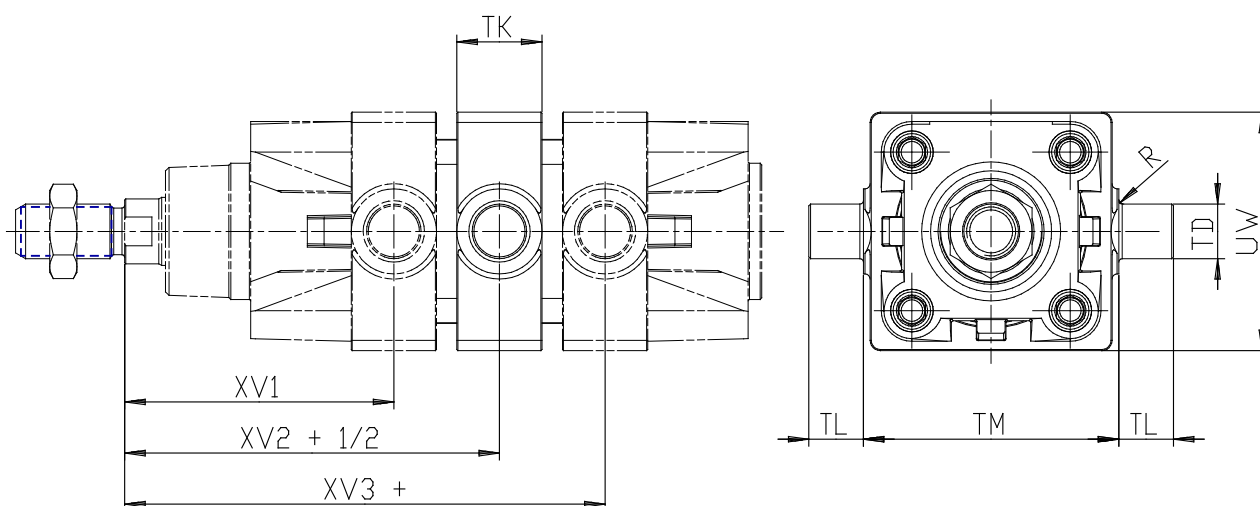

DIMENSIONI

XV1 (mm)	62.0
XV2 (mm)	73.0
XV3 (mm)	84.0
TM (mm)	50
TK (mm)	20
TD (mm)	12
TL (mm)	12
UW (mm)	50
R (mm)	0.50