

Ancoraggio a cerniera intermedia - Mod. F

Codice prodotto: F-80

Data di creazione del data sheet: 13/05/26 15.36

Verifica il documento più aggiornato online [clicca qui](#)



SCHEDA TECNICA

Mod.	F-80
------	------

Ancoraggio a cerniera intermedia - Mod. F

Codice prodotto: F-80

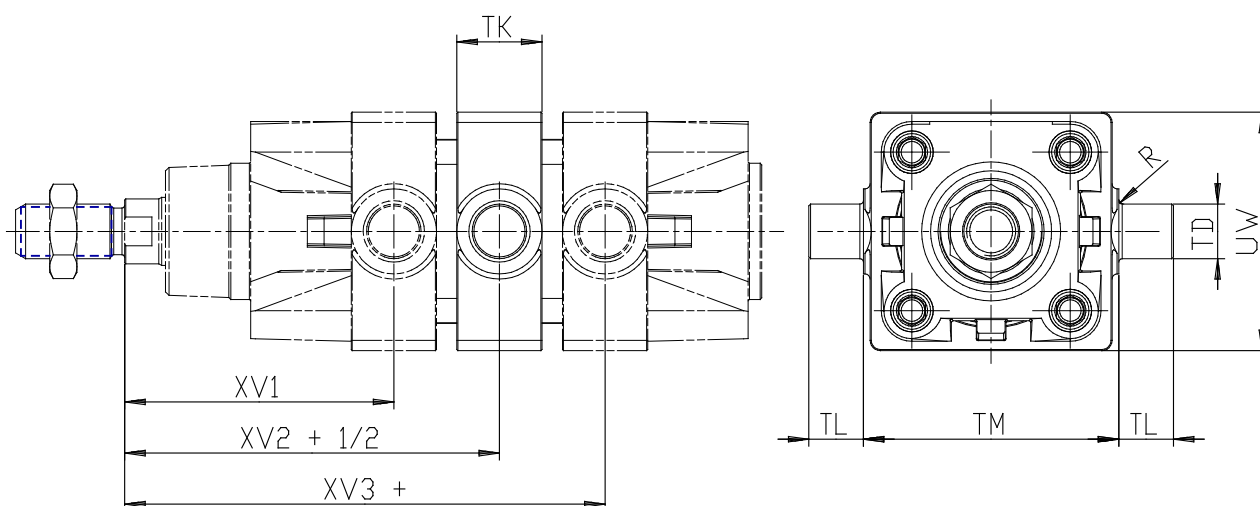

DIMENSIONI

XV1 (mm)	97.0
XV2 (mm)	110.0
XV3 (mm)	123.0
TM (mm)	110
TK (mm)	30
TD (mm)	20
TL (mm)	20
UW (mm)	105
R (mm)	1.00