

Ancoraggio cerniera anteriore/posteriore con viti - Mod. FN

Codice prodotto: FN-100

Data di creazione del data sheet: 13/05/26 15.30

Verifica il documento più aggiornato online [clicca qui](#)



SCHEDA TECNICA

Serie	32
Mod.	FN-100
Diametro (mm)	Ø100

Ancoraggio cerniera anteriore/posteriore con viti - Mod. FN

Codice prodotto: FN-100

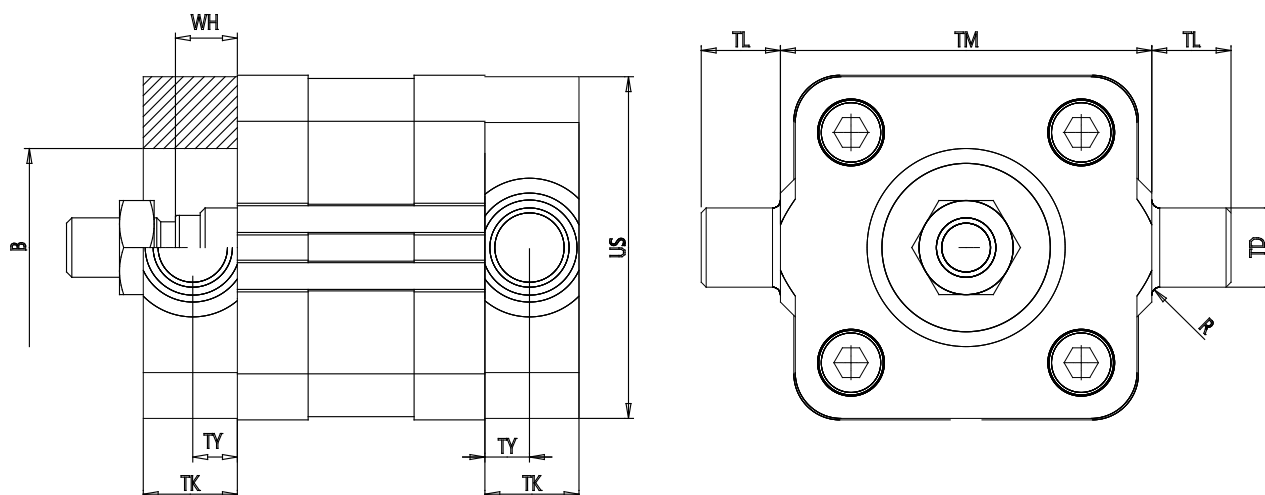

DIMENSIONI

TK (TK / mm)	29
TY (TY / mm)	14.0
WH (WH / mm)	9.7
B (B / mm)	55
XH (XH / mm)	37.0
XL (XL / mm)	203.0
US (US / mm)	125
TL (TL / mm)	25
TM (TM / mm)	132
TD (TD / mm)	25
R (R / mm)	2.0