

Ancoraggio cerniera anteriore/posteriore con viti - Mod. FN

Codice prodotto: FN-32

Data di creazione del data sheet: 13/05/26 15.23

Verifica il documento più aggiornato online [clicca qui](#)



SCHEDA TECNICA

Serie	32
Mod.	FN-32
Diametro (mm)	Ø32

Ancoraggio cerniera anteriore/posteriore con viti - Mod. FN

Codice prodotto: FN-32

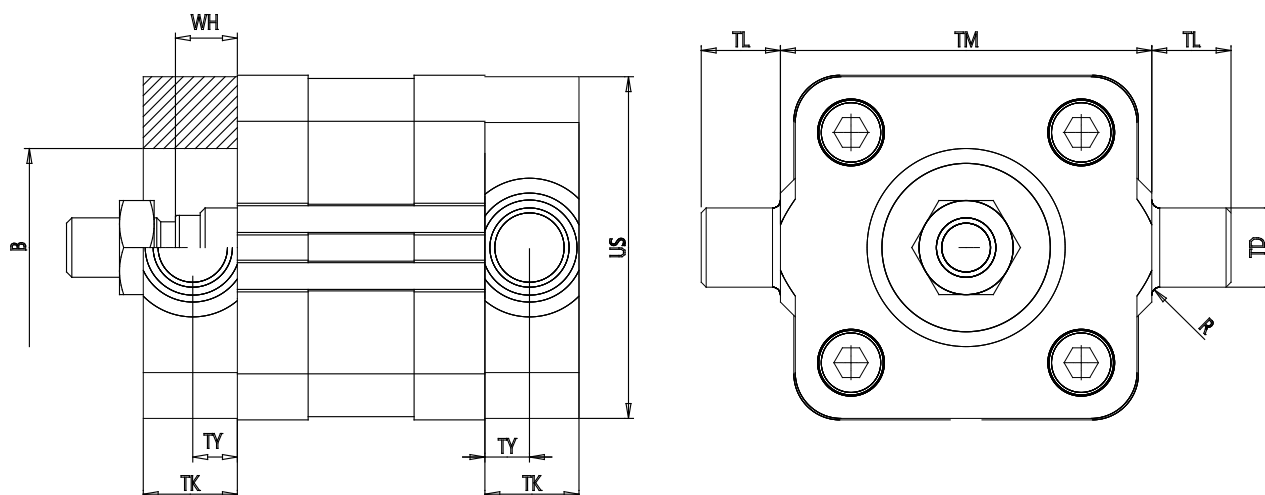

DIMENSIONI

TK (TK / mm)	14
TY (TY / mm)	6.5
WH (WH / mm)	7.0
B (B / mm)	30
XH (XH / mm)	19.5
XL (XL / mm)	126.5
US (US / mm)	46
TL (TL / mm)	12
TM (TM / mm)	50
TD (TD / mm)	12
R (R / mm)	1.0