

Ancoraggio cerniera anteriore/posteriore con viti - Mod. FN

Codice prodotto: FN-40

Data di creazione del data sheet: 13/05/26 15.30

Verifica il documento più aggiornato online [clicca qui](#)



SCHEDA TECNICA

Serie	32
Mod.	FN-40
Diametro (mm)	Ø40

Ancoraggio cerniera anteriore/posteriore con viti - Mod. FN

Codice prodotto: FN-40

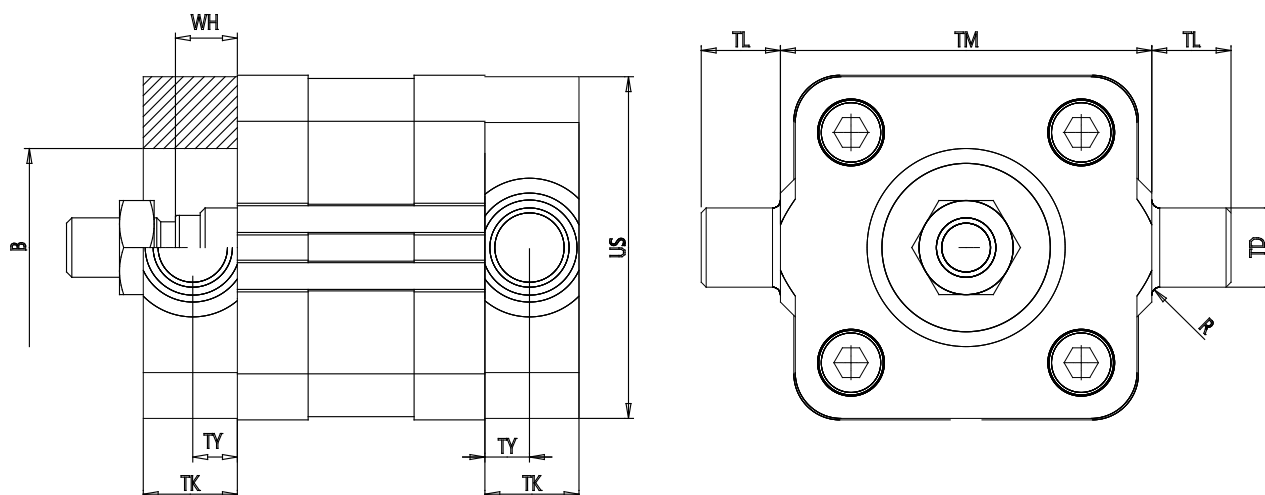

DIMENSIONI

TK (TK / mm)	19
TY (TY / mm)	9.0
WH (WH / mm)	7.0
B (B / mm)	35
XH (XH / mm)	21.0
XL (XL / mm)	144.0
US (US / mm)	59
TL (TL / mm)	16
TM (TM / mm)	63
TD (TD / mm)	16
R (R / mm)	1.5