

## Ancoraggio cerniera anteriore/posteriore con viti - Mod. FN

Codice prodotto: FN-50

Data di creazione del data sheet: 13/05/26 15.37

Verifica il documento più aggiornato online [clicca qui](#)



### SCHEDA TECNICA

<b>Serie</b>	32
<b>Mod.</b>	FN-50
<b>Diametro (mm)</b>	Ø50

## Ancoraggio cerniera anteriore/posteriore con viti - Mod. FN

Codice prodotto: FN-50

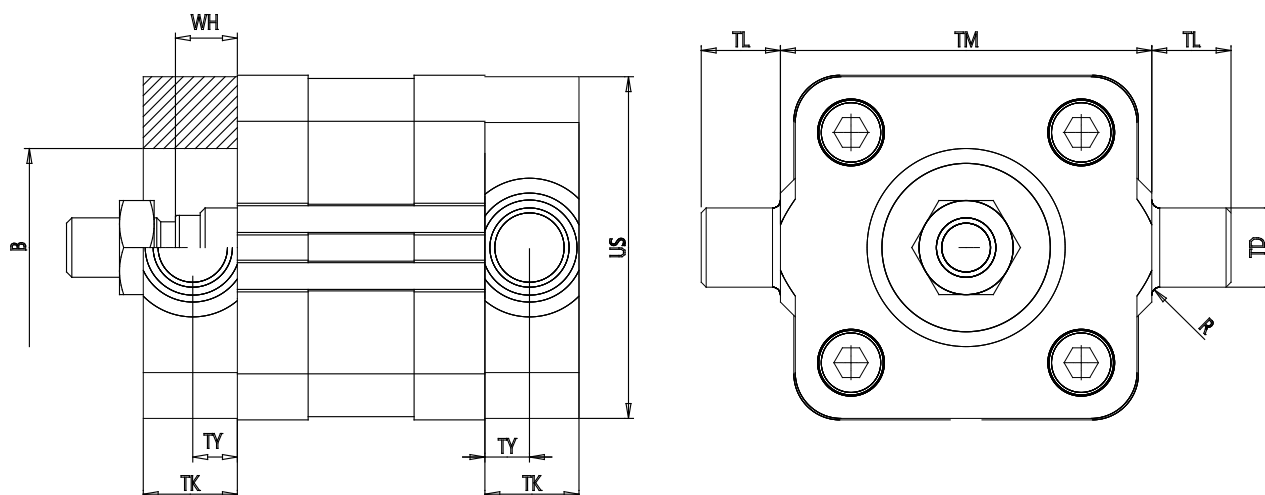

### DIMENSIONI

TK (TK / mm)	19
TY (TY / mm)	9.0
WH (WH / mm)	8.0
B (B / mm)	40
XH (XH / mm)	28.0
XL (XL / mm)	152.0
US (US / mm)	69
TL (TL / mm)	16
TM (TM / mm)	75
TD (TD / mm)	16
R (R / mm)	1.6