

Snodo sferico maschio - Mod. GY

Codice prodotto: GY-20

Data di creazione del data sheet: 13/05/26 15.38

Verifica il documento più aggiornato online [clicca qui](#)



SCHEDA TECNICA

Mod.	GY-20
------	-------

Snodo sferico maschio - Mod. GY

Codice prodotto: GY-20

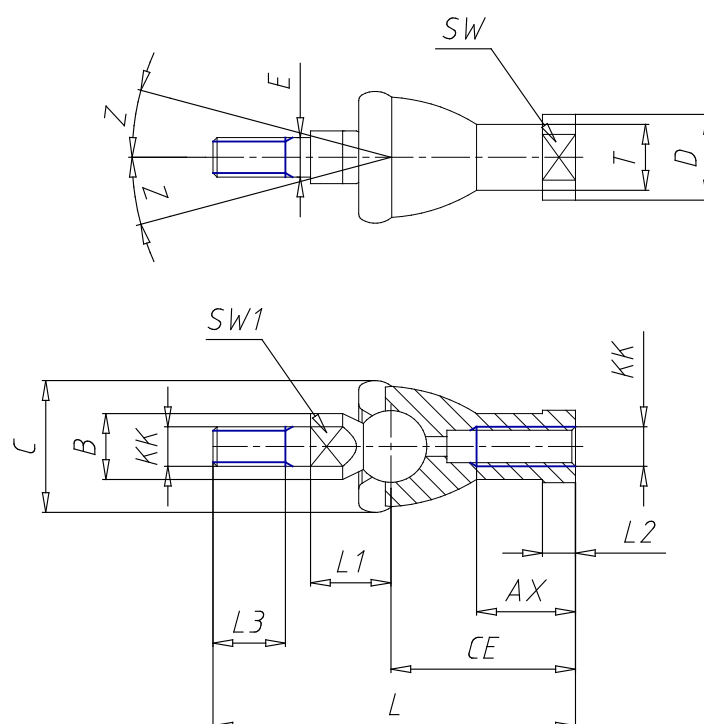

DIMENSIONI

KK	M 8x1.25
L (mm)	65
CE (mm)	32
L2 (mm)	5.0
AX (mm)	16
E (mm)	8
Ø B (mm)	12
Ø C (mm)	24
Ø T (mm)	12.5
Ø D (mm)	16
L1 (mm)	16.0
L3 (mm)	12
SW1 (mm)	10
SW (mm)	14
Z (mm)	15