

Supporto 90° per cerniera - Mod. I

Codice prodotto: I-12-16

Data di creazione del data sheet: 13/05/26 15.35

Verifica il documento più aggiornato online [clicca qui](#)



SCHEDA TECNICA

Mod.	I-12-16
------	---------

Supporto 90° per cerniera - Mod. I

Codice prodotto: I-12-16

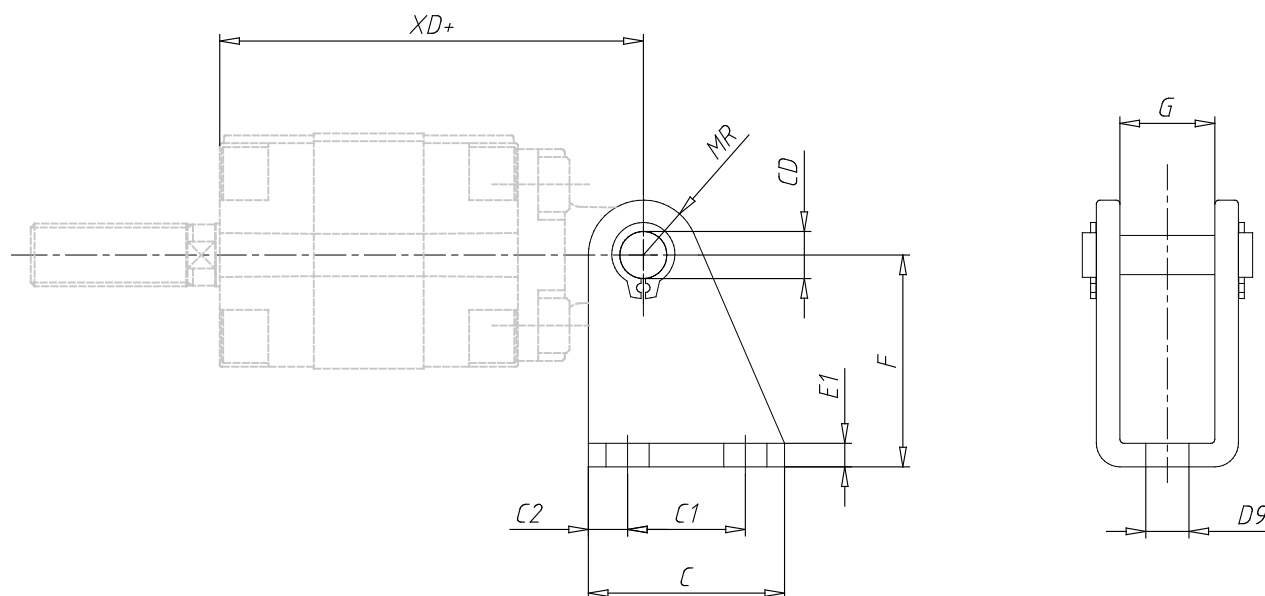

DIMENSIONI

Ø CD (mm)	6
C (mm)	25
C1 (mm)	15
Ø C2 (mm)	5
XD (mm)	54.0
MR (mm)	7
Ø D9 (mm)	5.5
E1 (mm)	3
F (mm)	27
G (mm)	12.1