

Regolatori - Serie MC

Codice prodotto: MC104-R05

Data di creazione del data sheet: 14/05/26 12.33

Verifica il documento più aggiornato online [clicca qui](#)



SCHEDA TECNICA

Mod.	MC104-R05
U	G1/4

Regolatori - Serie MC

Codice prodotto: MC104-R05

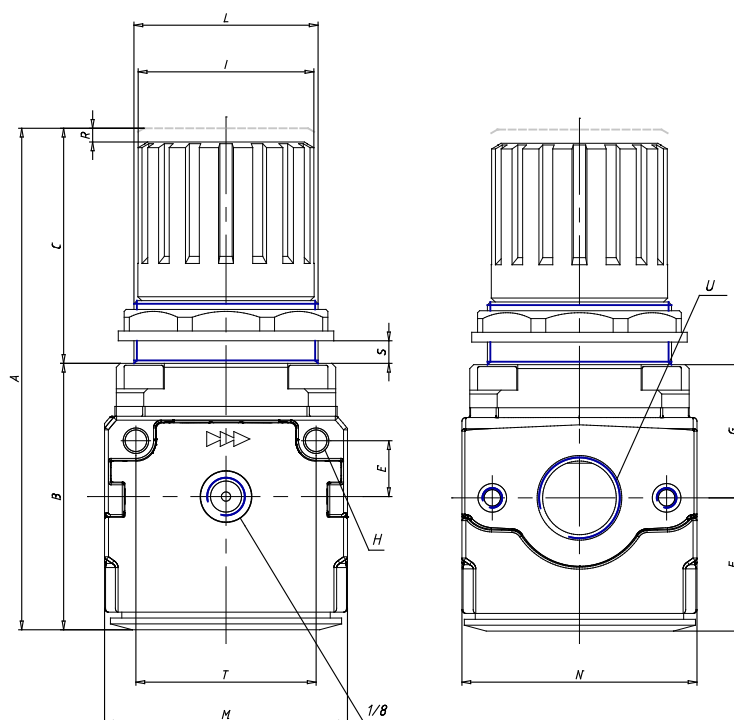

DIMENSIONI

A (mm)	94
B (mm)	56
C (mm)	38
E (mm)	11
F (mm)	28.5
G (mm)	27.5
H (mm)	4.5
I (mm)	28
L	30x1.5
M (mm)	45
N (mm)	45
R (mm)	3.0
S	0:6
T (mm)	35