



***Operation and maintenance instructions for Series PME CANopen Electronic
proportional regulator***



Made in Italy

The products are designed and manufactured in conformity with the following directives:

- 2014/30/UE "Electromagnetic compatibility"

They also comply partially or totally with regard to the applicable parts of the following standards:

- EN 61000-6-2:2005 Electromagnetic compatibility (EMC) — Part 6-2:
Generic standards - Immunity for industrial environments
- EN 61000-6-4:2007 Electromagnetic compatibility (EMC) — Part 6-4: Generic standards -
Emissions for industrial environments
- UL 61010-1: Safety requirements for electrical equipment for measurement, control and
laboratory use Part 1: General requirements and the following technical standards

and to the following technical standards:

- EN ISO 4414:2010 Pneumatics - General rules and safety requirements for systems and their
components.

For more information regarding the declarations of conformity, see the Certifications section
on the website <http://catalogue.camozzi.com>.

	Operation and maintenance instructions Series PME CANopen proportional pressure regulator	5000054187
		Ver. 01

Index

1.	Product identification	5
2.	Introduction	6
3.	General recommendations	6
4.	Product description.....	7
5.	Pneumatic symbol.....	8
6.	General characteristics and conditions of use	9
7.	Electrical/Pneumatic circuit	17
8.	Product storage and transport.....	17
9.	Installation and start-up.....	17
10.	Device Configuration.....	24
10.1.	Information.....	25
10.2.	Fieldbus	26
10.3.	Configurator	26
10.3.1.	User setup.....	27
10.3.2.	K parameters.....	29
10.3.3.	Feedback setup	29
10.3.4.	Specific device setup.....	30
10.3.5.	Password.....	31
10.3.6.	Saving parameters	31
11.	CANopen pressure regulator	32
11.1.	Configuration via EDS file	32
11.2.	Address and baud rate	32
11.3.	Object dictionary	33
11.3.1.	CiA 301 profile objects.....	33
11.3.2.	CiA 301 profile objects description.....	40
11.3.2.1.	1000h Device type	40
11.3.2.2.	1001h Error register.....	40
11.3.2.3.	1002h Manufacturer status register.....	40
11.3.2.4.	1003h Pre-defined error field	40
11.3.2.5.	1005h COB-ID sync	41

	Operation and maintenance instructions Series PME CANopen proportional pressure regulator	5000054187
		Ver. 01

11.3.2.6.	1006h Communication cycle period	41
11.3.2.7.	1007h Synchronous window length	41
11.3.2.8.	1008h Manufacturer device name	41
11.3.2.9.	1009h Manufacturer hardware version	41
11.3.2.10.	100Ah Manufacturer software version.....	41
11.3.2.11.	100Ch Guard time	42
11.3.2.12.	100Dh Life time factor	42
11.3.2.13.	1010h Store parameter field.....	42
11.3.2.14.	1011h Restore default parameter	42
11.3.2.15.	1012h COIB-ID time stamp.....	42
11.3.2.16.	1014h COIB-ID EMCY.....	43
11.3.2.17.	1015h Inhibit time emergency.....	43
11.3.2.18.	1017h Producer heartbeat time	43
11.3.2.19.	1018h Identity object.....	43
11.3.2.20.	1019h Synchronous counter overflow value	43
11.3.2.21.	1029h Error behaviour	44
11.3.2.22.	1200h Server SDO parameter 1	44
11.3.2.23.	1400h – 1407h Receive PDO Communication Parameter	44
11.3.2.24.	1600h – 1607h Receive PDO Mapping Parameter	45
11.3.2.25.	1800h – 1807h Transmit PDO Communication Parameter	45
11.3.2.26.	1A00h – 1A07h Transmit PDO Mapping Parameter	46
11.3.2.27.	1F80h NMT Startup.....	46
11.4.	CiA 408 profile objects	47
11.4.1.	CiA 408 profile objects description.....	47
11.4.1.1.	6040h Control Word	48
11.4.1.2.	6041h Status Word	50
11.4.1.3.	6042h Device Mode.....	50
11.4.1.4.	6043h Device control Mode	50
11.4.1.5.	604Fh Device Local	50
11.4.1.6.	6380h VRPC Setpoint.....	50
11.4.1.7.	6381h VRPC Actual Value	51

	Operation and maintenance instructions Series PME CANopen proportional pressure regulator	5000054187
		Ver. 01

11.5.	Manufacturer Objects	52
11.5.1.	Manufacturer objects description	53
11.5.1.1.	2001h Pressure regulation check mode	53
11.5.1.2.	2002h Enable pressure regulation check	53
11.5.1.3.	2003h Pressure regulation check timeout	53
11.5.1.4.	2004h Pressure regulation protection timeout.....	53
11.5.1.5.	2007h Fail safe	53
11.5.1.6.	2008h PID mode	53
11.5.1.7.	2009h PID Custom Parameter	54
11.5.1.8.	220Bh Numerator multiplier	54
11.5.1.9.	220Ch Denominator multiplier	54
11.5.1.10.	200Dh Error code	54
11.5.1.11.	200Eh Dead band	55
11.5.1.12.	200Fh Enable pressure switch control.....	55
11.5.1.13.	2010h Lower limit switch control	56
11.5.1.14.	2011h Upper limit switch control	56
11.5.1.15.	2012h Enable pressure window control	56
11.5.1.16.	2013h Lower limit window control.....	57
11.5.1.17.	2014h Upper limit window control.....	57
11.5.1.18.	2015h Use profile CiA 408.....	57
11.5.1.19.	2016h Enable Termination Resistance.....	57
11.5.1.20.	2017h Enable Emergency Transmission	58
11.5.1.21.	2018h Hysteresis.....	58
11.5.1.22.	2019h Internal sensor filter cutoff	59
12.	Diagnostic.....	60
13.	Use.....	61
14.	Limitations on use	62
15.	Maintenance	62
16.	Environmental notes.....	62
17.	Contacts	64

1. Product identification

	<p align="center">Conversion table for the production date.</p>	86-1400-0001 Rev. D
		Leaf 02 / 02

Position 1 and 2: n° of the week.			
01	14	27	40
02	15	28	41
03	16	29	42
04	17	30	43
05	18	31	44
06	19	32	45
07	20	33	46
08	21	34	47
09	22	35	48
10	23	36	49
11	24	37	50
12	25	38	51
13	26	39	52

Position 3: One letter for the present Year.				
A		1996	2021	2046
B		1997	2022	2047
C		1998	2023	2048
D		1999	2024	2049
E		2000	2025	2050
F		2001	2026	2051
G		2002	2027	2052
H		2003	2028	2053
I		2004	2029	2054
K		2005	2030	2055
L		2006	2031	2056
M		2007	2032	2057
N		2008	2033	2058
O		2009	2034	2059
P		2010	2035	2060
Q		2011	2036	2061
R		2012	2037	2062
S	1988	2013	2038	2063
T	1989	2014	2039	2064
U	1990	2015	2040	2065
V	1991	2016	2041	2066
W	1992	2017	2042	2067
X	1993	2018	2043	2068
Y	1994	2019	2044	2069
Z	1995	2020	2045	2070

Example of composition.	
03P	
Description:	
03	Week n° 03
P	Year 2010

Managing authority: Industrial Engineering	Date: 9 April 2010	Created by: Marco Bontempi	Approved by: Bruno Ghizzardi
-----------------------------------------------	-----------------------	-------------------------------	---------------------------------

	Operation and maintenance instructions Series PME CANopen proportional pressure regulator	5000054187
		Ver. 01

2. Introduction

This manual illustrates how to properly use the **Series PME electronic pressure regulator** with CANopen interface.

This version of the Controller is identified with code 0214 xx xx xxx x xxxxx, where 0214 indicates the version of regulator and is followed by year, week, machine, station and serial number.

3. General recommendations

The recommendations regarding safe use in this document should be observed at all times.

- Some hazards can only be associated with the product after it has been installed on the machine/equipment. It is the task of the final user to identify these hazards and reduced the associated risks accordingly.
- The products dealt with in this manual may be used in circuits that must comply with the standard EN ISO 13849-1.
- For information regarding component reliability, contact Camozzi.
- Before proceeding with use of the product, carefully read all information in this document.
- The instructions in this manual must be observed together with the instructions and additional information regarding the product in this manual, available from the following reference links:
 - web site <http://www.camozzi.com>
 - Camozzi general catalogue
 - Technical assistance service
- Assembly and start-up operations must be performed exclusively by qualified and authorized personnel on the basis of these instructions.
- It is the responsibility of the system/machine designer to ensure the correct selection of the most suitable pneumatic component according to the intended application.
- For all situations not contemplated in this manual and in situations in which there is the risk of potential damage to objects, or injury to persons or animals, contact Camozzi for advice.
- Never make unauthorized modifications to the product. In this case, any damage or injury to objects, persons or animals will be the responsibility of the user.
- All relevant product safety standards must be observed at all times.
- Never intervene on the machine/system before verifying that all working conditions are safe.
- Before installation and maintenance, ensure that the specific envisaged safety locks are active, and then disconnect the electrical mains (if necessary) and system pressure supply, discharging all residual compressed air from the circuit and deactivating residual energy stored in springs, condensers, recipients and gravity.
- To reduce the noise levels caused by the discharge of air from the component, envisage the use of silencers or convey the fluid to a zone where no personnel are envisaged during normal operation.
- Avoid covering the equipment with paint or other substances that may reduce heat dissipation.

- Avoid cleaning with aggressive agents such as to dull the plastics and make it difficult to read the screen
- **In the event of an electrical power failure and pneumatic supply at the port connection 1, the regulated pressure on port connection 2 will not be maintained and can be discharged.**

4. Product description

The Series PME electronic pressure regulator is composed of:

- M12 5 pin connector (1): provides connection to power supply and command signal (for more details refer to the paragraph "Installation and Commissioning").

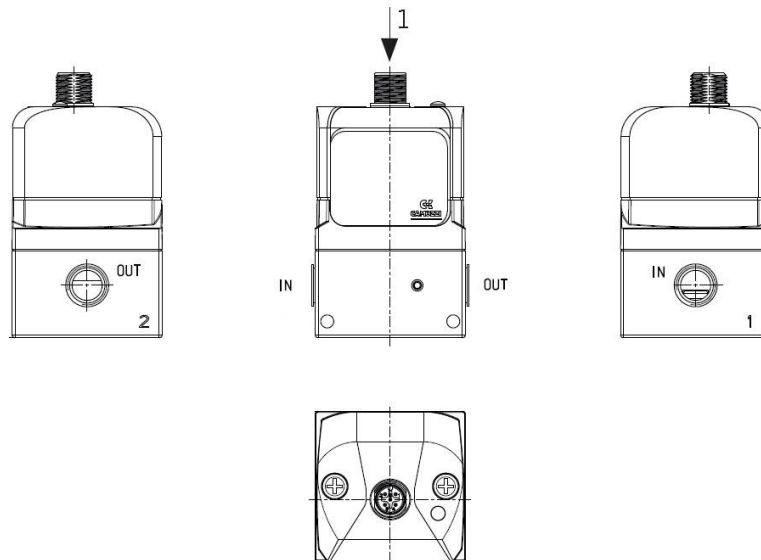

Only one version of PME CANopen is available.

The configuration of some features of the Series PME electronic pressure regulator and of CANopen parameters is done through the NFCamApp app.

5. Pneumatic symbol

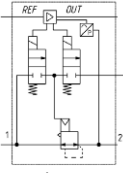
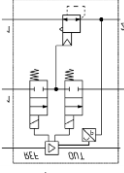
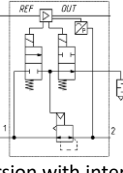
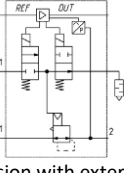
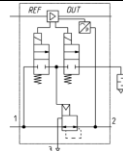
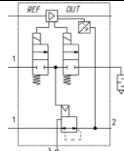
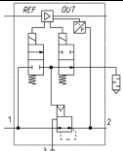
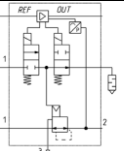
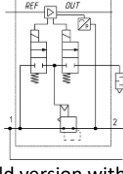
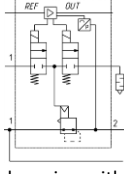
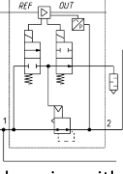
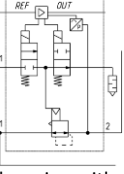
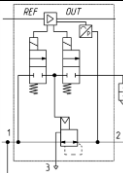
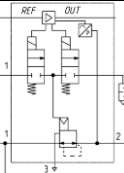
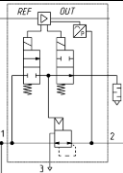
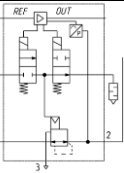
SIZE 1 AND 2			
			
<p>Version with internal servo-pilot supply, two pilot valves 2/2 NC.</p>	<p>Version with external servo-pilot supply, two pilot valves 2/2 NC.</p>	<p>Version with internal servo-pilot supply and two pilot valves; one 2/2 NC and one 2/2 NO (exhaust).</p>	<p>Version with external servo-pilot supply and two pilot valves; one 2/2 NC and one 2/2 NO (exhaust).</p>
			
<p>Version with internal servo-pilot supply and two pilot valves 2/2 NC, exhaust conveyable.</p>	<p>Version with external servo-pilot supply and two pilot valves 2/2 NC, exhaust conveyable.</p>	<p>Version with internal servo-pilot supply and two pilot valves; one 2/2 NC and one 2/2 NO to exhaust, exhaust conveyable.</p>	<p>Version with external servo-pilot supply and two pilot valves; one 2/2 NC and one 2/2 NO to exhaust, exhaust conveyable.</p>
SIZE 1 AND 2 MANIFOLD			
			
<p>Manifold version with internal servo-pilot supply and two pilot valves 2/2 NC.</p>	<p>Manifold version with external servo-pilot supply and two pilot valves 2/2 NC.</p>	<p>Manifold version with internal servo-pilot supply and two pilot valves; one 2/2 NC and one 2/2 NO to exhaust.</p>	<p>Manifold version with external servo-pilot supply and two pilot valves; one 2/2 NC and one 2/2 NO to exhaust.</p>
			
<p>Manifold version with internal servo-pilot supply and two pilot valves 2/2 NC and exhaust conveyable.</p>	<p>Manifold version with external servo-pilot supply and two pilot valves 2/2 NC and exhaust conveyable.</p>	<p>Manifold version with internal servo-pilot supply and two pilot valves; one 2/2 NC and one 2/2 NO to exhaust, exhaust conveyable.</p>	<p>Manifold version with external servo-pilot supply and two pilot valves; one 2/2 NC and one 2/2 NO to exhaust, exhaust conveyable.</p>

	Operation and maintenance instructions Series PME CANopen proportional pressure regulator	5000054187
		Ver. 01

6. General characteristics and conditions of use

General characteristics and conditions of use		
	PME1	PME2
Reference standards	CE; RoHs	
Materials	Body: Aluminum Cover: Technopolymer Seal:NBR and FKM	
Assembly position	Any	
Overall dimensions	L = 50 mm; W = 50 mm; H = 88 mm	L = 50 mm; W = 50 mm; H = 133 mm
Weight	350gr circa	630gr circa
Medium and its quality	Filtered and non-lubricated compressed air of class 7.4.4 according to ISO 8573.1. Inert gases and oxygen only for OX1 versions.	
Maximum free flow rate (Pin 10 bar) Measured at $\pm 5\%$ of Preg	Pout 6 bar: 1.100 l/min ANR (PRE104) Pout 4 bar: 1.200 l/min ANR (PRE104)	Pout 6 bar: 4.500 l/min ANR (PRE238) Pout 4 bar: 5.200 l/min ANR (PRE238)
Maximum system pressure drops	20 cc/min	10 cc/min
Maximum inlet pressure (refer to coding table)	11 bar (D); (G) and (F)	
Regulated pressure range	0,05 - 10,3 bar (0,72-150 PSI)(D) 0,05 - 6 bar (0,72-87 PSI)(F) 0,05 - 7 bar (0,72-101,5 PSI) (G)	
Number of ways	3	
Ambient temperature	0 ÷ 50 °C	
Protection class	IP65 (according to EN 60529) Open-type (according to UL 61010)	
Pneumatic ports	Standard version: G1/4; G1/8; 1/4 NPTF Manifold version: G1/4; G1/8; 1/4 NPTF	Standard version: G1/4, G3/8 Manifold version: G1/4
Vibrations sine According to EN 60068 part 2-6:2009-11 (table B.1)	Frequency range: 10-500Hz Displacement 0-peak: 0,75mm or 100 m/s ² Number of cycles: 10	
Continuous shock According to DIN EN 60068-2-27:2010-02 (table A.1)	Peak acceleration: 150 m/s ² Duration: 11ms Pulse shape: half sine	
Electric port	M12 5 Pin Male A-key	
Input signal setpoint	CANopen profile Cia301 and Cia408 (optional)	
Factory values	Address: 127; Baud Rate: 1Mbps; Unit of measure for pressure: mBar	

	Operation and maintenance instructions Series PME CANopen proportional pressure regulator	5000054187
		Ver. 01

Electrical power supply	12 -10% 24 +10% Vdc	
Current consumption	Max 0,250A (refer to the table below for more details)	
Hysteresis (*)	0,5% FS	0,7% FS
Repeatability (*)	0,4% FS	0,4% FS
Linearity (*)	0,3% FS	0,3% FS
Resolution (*)	0,3% FS	0,6% FS
Overpressure discharge	With relieving	
Modularity	With Series MD	

(*) measured with Inlet pressure = Maximum regulated pressure + 1bar and a volume connected to the outlet without any loss.

Integrated exhaust valve	Code	Maximum current consumption
NO	PMExxx-Ex5xxx-xx PMExxx-Ex7xxx-xx	0,150 A
SI	PMExxx-Ex6xxx-xx PMExxx-Ex8xxx-xx	0,200 A

- Efficiency curve

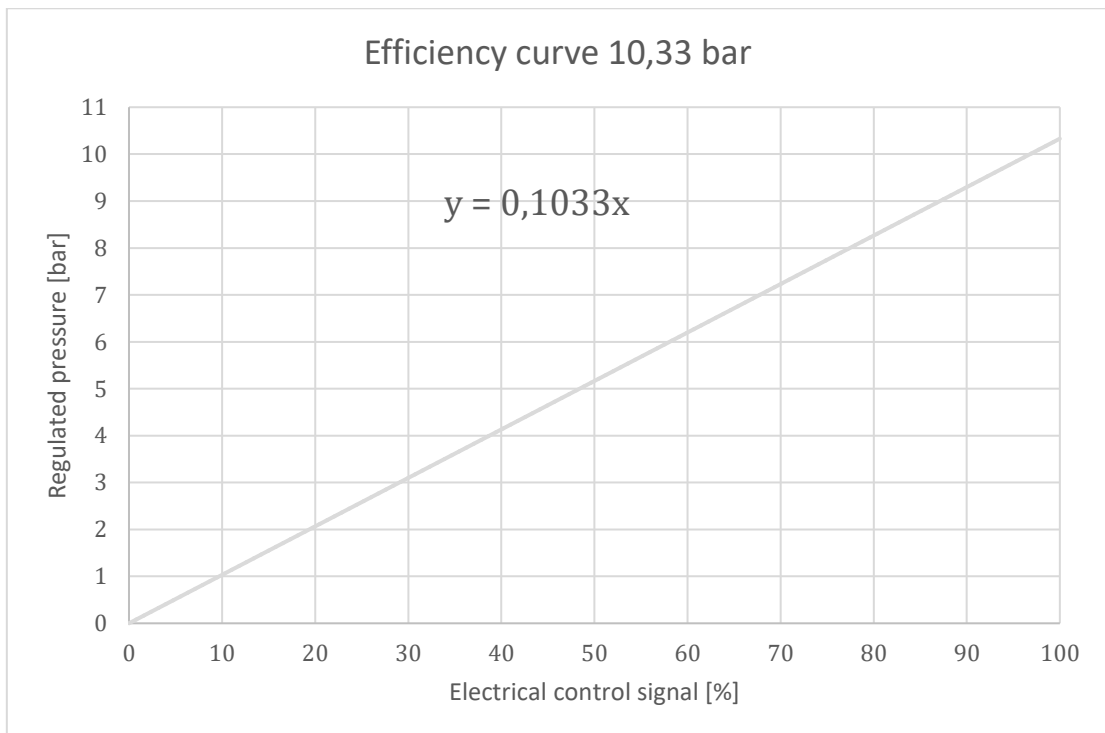

- FLOW CHARTS SIZE 1 - Standard version (1/4G)

Typical curve for version PME104-EF...

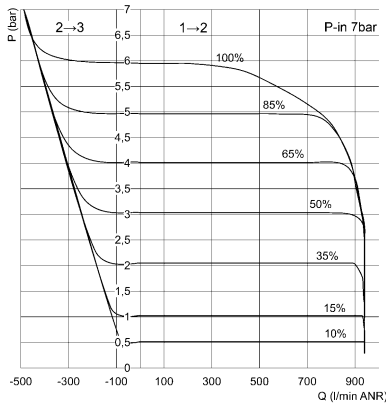

P = Regulated outlet pressure and exhaust pressure
 Q = Flow
 % = Percentage of the command signal

Typical curve for version PME104-EG...

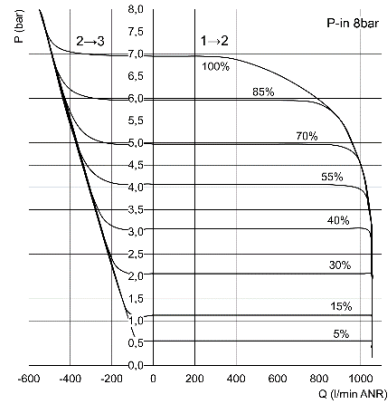

P = Regulated outlet pressure and exhaust pressure
 Q = Flow
 % = Percentage of the command signal

Typical curve for version PME104-ED...

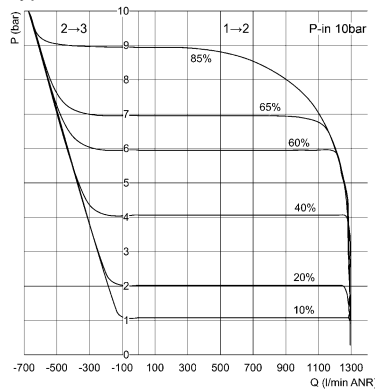

P = Regulated outlet pressure and exhaust pressure
 Q = Flow
 % = Percentage of the command signal

- FLOW CHARTS SIZE 1 – Manifold version (1/4G)

Typical curve for version PME1M4-EF...

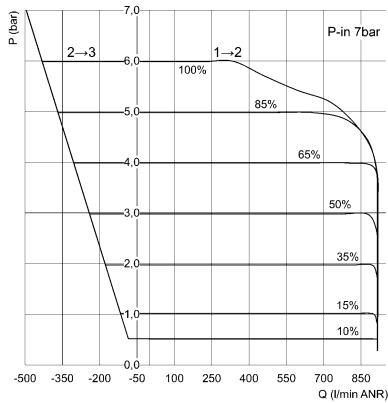

P = Regulated outlet pressure and exhaust pressure
 Q = Flow
 % = Percentage of the command signal

Typical curve for version PME104-EG...

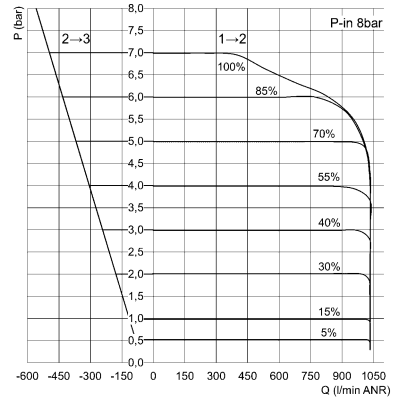

P = Regulated outlet pressure and exhaust pressure
 Q = Flow
 % = Percentage of the command signal

Typical curve for version PME104-ED...

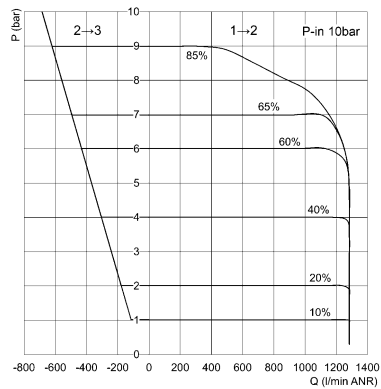

P = Regulated outlet pressure and exhaust pressure
 Q = Flow
 % = Percentage of the command signal

DECAY FACTOR FOR MANIFOLD REGULATOR SIZE 1

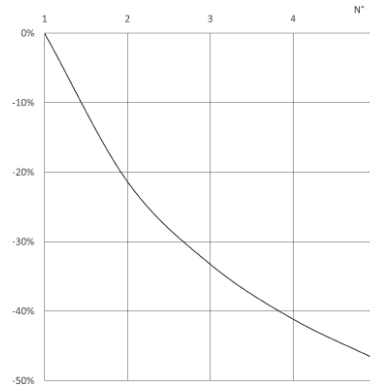

N* = number of regulators in manifold configuration
 % = relative percentage decay of the maximum flow rate
 Note: the air inlet is only from one side, in case it should be on the right and on the left, only consider the positions as from 1 ÷ 3..

- FLOW CHARTS SIZE 2 - Standard version (1/4G)

Typical curve for version PME204-EF...

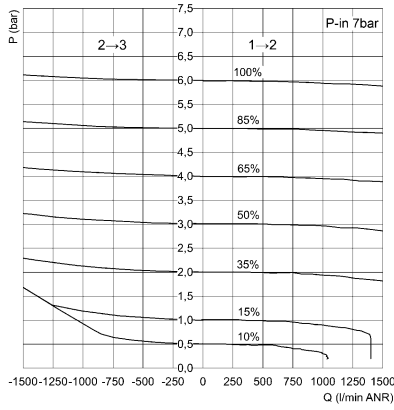

P = Regulated outlet pressure and exhaust pressure
 Q = Flow
 % = Percentage of the command signal

Typical curve for version PME204-EG...

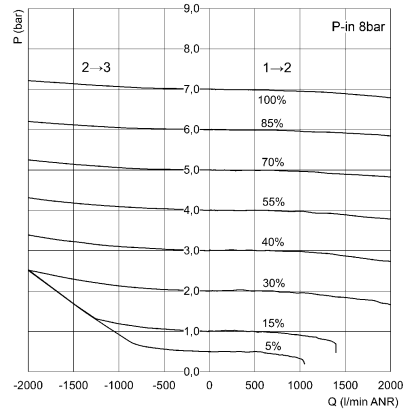

P = Regulated outlet pressure and exhaust pressure
 Q = Flow
 % = Percentage of the command signal

Typical curve for version PME204-ED...

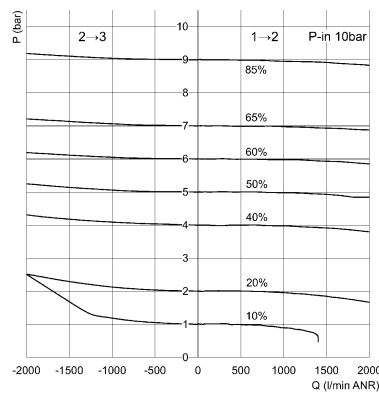

P = Regulated outlet pressure and exhaust pressure
 Q = Flow
 % = Percentage of the command signal

- FLOW CHARTS SIZE 2 - Standard version (3/8G)

Typical curve for version PME238-EF...

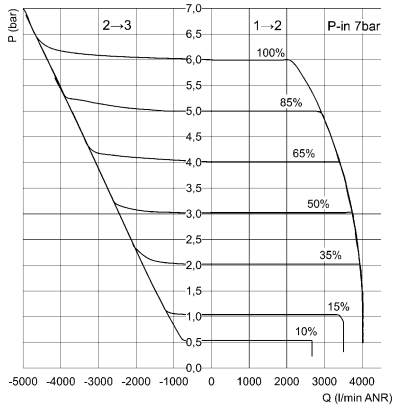

P = Regulated outlet pressure and exhaust pressure
 Q = Flow
 % = Percentage of the command signal

Typical curve for version PME238-EG...

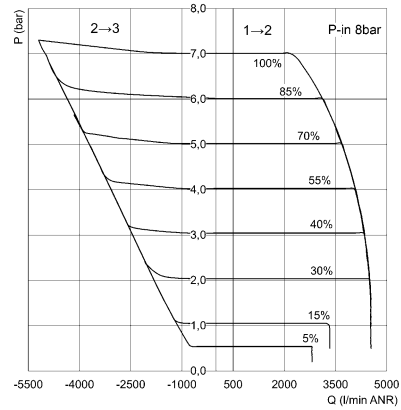

P = Regulated outlet pressure and exhaust pressure
 Q = Flow
 % = Percentage of the command signal

Typical curve for version PME238-ED...

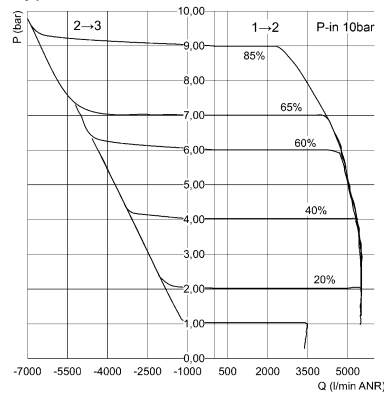

P = Regulated outlet pressure and exhaust pressure
 Q = Flow
 % = Percentage of the command signal

- FLOW CHARTS SIZE 2 – Manifold version (1/4G)

Typical curve for version PME2M4-EF...

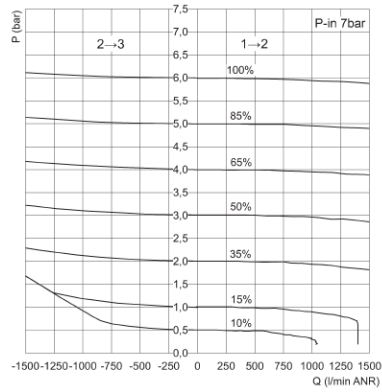

P = Regulated outlet pressure and exhaust pressure
 Q = Flow
 % = Percentage of the command signal

Typical curve for version PME204-EG...

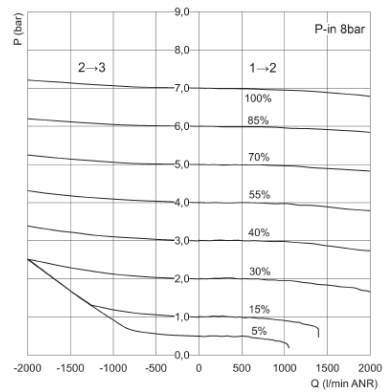

P = Regulated outlet pressure and exhaust pressure
 Q = Flow
 % = Percentage of the command signal

Typical curve for version PME204-ED...

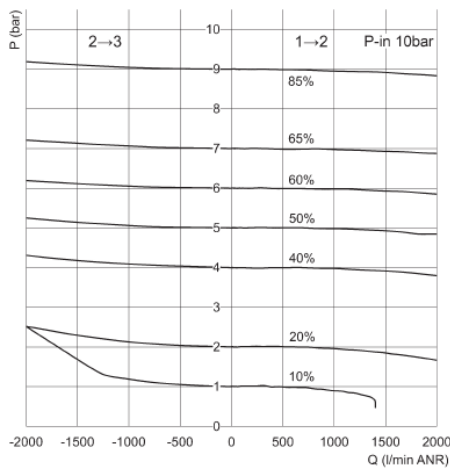

P = Regulated outlet pressure and exhaust pressure
 Q = Flow
 % = Percentage of the command signal

DECAY FACTOR FOR MANIFOLD REGULATOR SIZE 2

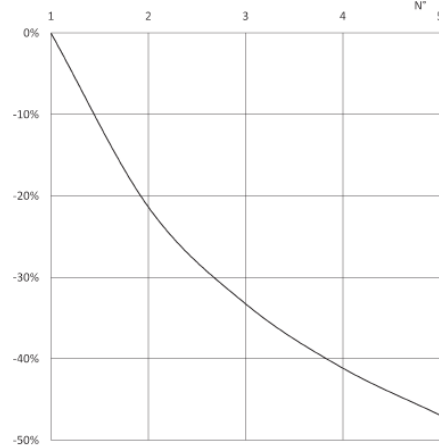

N* = number of regulators in manifold configuration
 % = relative percentage decay of the maximum flow rate
 Note: the air inlet is only from one side, in case it should be on the right and on the left, only consider the positions as from 1 ÷ 3..

- Step response (Values determined according to ISO 10094-1)

PME-104				
Type of Dynamic tests	Dynamic Characteristics	No tank	Volume 0,4L	Volume 2L
Step 0% to 100%	Shifting Time [ms]	36	82	175
	Response Time [ms]	260	372	1.261
	Settling Time [ms]	179	247	934
Step 100% to 0%	Shifting Time [ms]	39	64	177
	Response Time [ms]	678	957	4.152
	Settling Time [ms]	470	708	3.170
PME-238				
Type of Dynamic tests	Dynamic Characteristics	No tank	Volume 0,4L	Volume 2L
Step 0% to 100%	Shifting Time [ms]	60	60	95
	Response Time [ms]	350	465	850
	Settling Time [ms]	250	325	650
Step 100% to 0%	Shifting Time [ms]	60	60	80
	Response Time [ms]	850	860	870
	Settling Time [ms]	600	590	565

7. Electrical/Pneumatic circuit

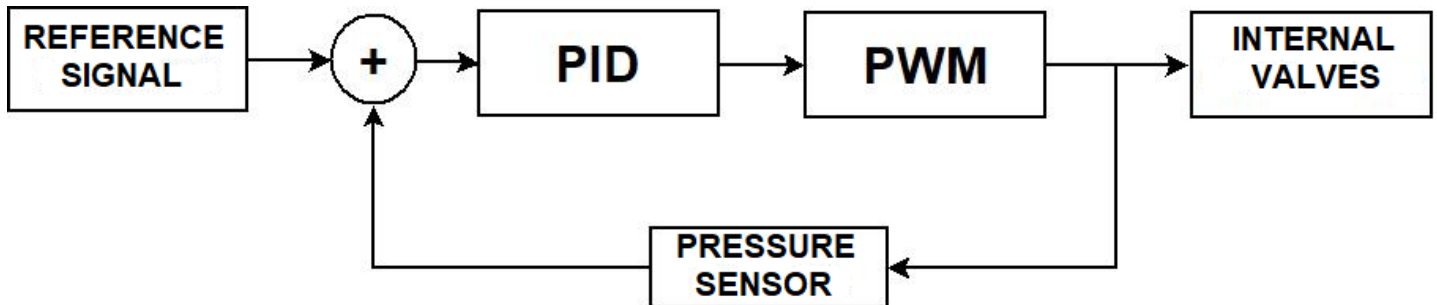

8. Product storage and transport

- Adopt all measures possible to avoid accidental damage to the product during transport, and when available use the original packaging.
- Observe the specified storage temperature range of $-20 \div 70$ °C.

9. Installation and start-up

- During unpacking, take great care not to damage the product.
- Check whether there are any faults caused by product transport or storage.
- Separate all packaging material to enable the recovery or disposal in accordance with current standards in the country of use.
- Where possible avoid the risk of repeated pressure surges on the circuit where the component is installed.
- The components must be fixed correctly using, where possible, the specific anchors and ensuring that the fixture remains efficient even when the actuator is repeatedly used at a high frequency and in the presence of strong vibrations.
- Once the component is installed, ensure that all air ways are securely connected to the respective couplings.
- If the power supply is turned off, residual pressure may remain on the secondary side of the regulators. The manufacturer must provide for additional exhaust components.

Recommended pneumatic circuit

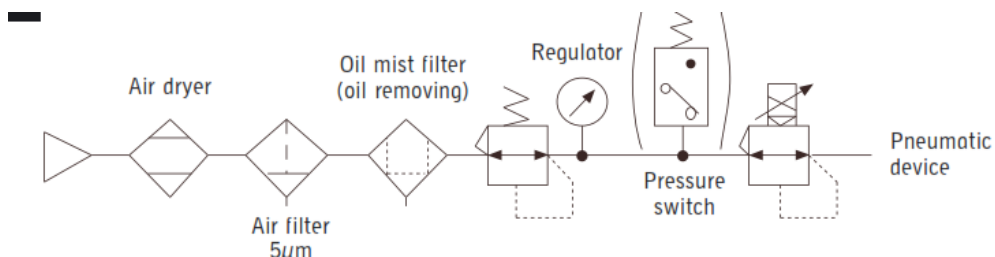

- Keep the protective cap of the M12 connector until the regulator is completely installed.

- PME1 series electronic regulator can be connected to DIN rails using the relative elements PCF-E520 fitted on the rear of the body using two M4 threaded holes.

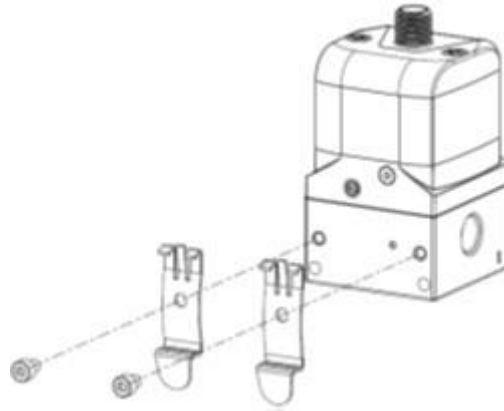

- The Series PME electronic regulator can be directly fixed to a support using the 2 through holes with diameter 4mm present on the body (not available in the PME1 manifold version).
- The PME electronic regulator can be fixed to the wall with the optional bracket code PRE-ST:
 1. Fix the bracket to the wall with suitable screws
 2. Connect the fittings G1/4; G3/8 or NPTF according to the PRE regulator size
 3. Connect the regulator to the bracket with the two M4 x 55 screws supplied

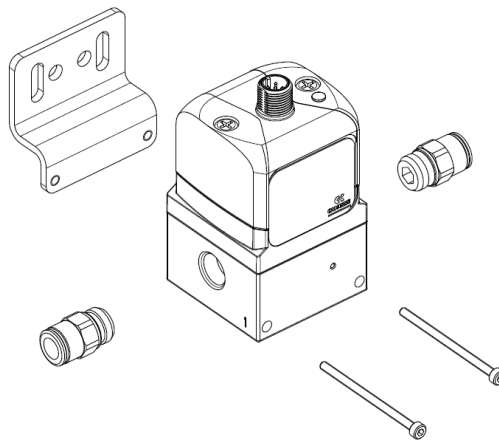

- Make sure that the bracket is completely resting on the wall
- Connection of Manifold regulators with related Kit PRE-M-Pin-1-2
 1. Insert the pins (1) in the seats on the regulator body
 2. Insert the O-ring seal (3) into the special seat on the side face of the body
 3. Bring the two modules sideways up until contact
 4. Tighten the four grub screws (2) until they are locked (Tightening torque: $2,5 \pm 0,5$ Nm)

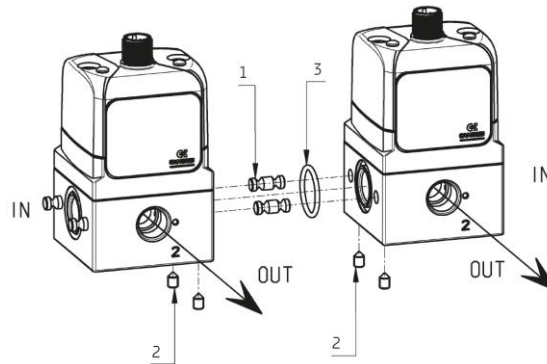

- There are 2 additional pneumatic ports on the PME series electronic regulator:
 - M5 to discharge the exhaust valve to the outside. It is important to keep this port free and clean to ensure that air is discharged without obstructions that could limit the flow. If necessary, only for version with conveyable port, remove the pre-assembled filter, connect a suitable coupling and use a hose to convey discharged air to a suitable area.
 - M5 for external servo-pilot supply. The regulator is supplied with a preassembled cap for the versions with internal servo-pilot supply and with the fitting 6625 3-M5 for the versions with external servo-pilot supply.
- In order to connect the regulator with MD series, use the PRE-1/4-C kit for regulator with G1/4 pneumatic port or use the PRE-3/8-C kit for regulator with G3/8 pneumatic port.
- The board implements a protection against inversion of polarity on the power supply voltage.
- The board is also fitted with a non-resettable 1A fuse to limit the maximum current absorption of the servovalve. Use a power supply unit able to deliver a current of at least 0,5A (recommended 1.0A).
- If UL/CSA standard compliance is required, the unit shall be supplied by an isolated power source which fulfils at least one of the following the requirements of:
 - Limited-Energy Circuit in accordance with UL/CSA 61010-1/ UL/CSA 61010-2-201
 - Limited Power Source (LPS) in accordance with UL/CSA 60950-1
 - a Class 2 supply source which complies with the National Electrical Code (NEC), NFPA 70, Clause 725.121 and Canadian Electrical Code (CEC), Part I, C22.1. (typical examples are a Class 2 transformer or a Class 2 power sources in compliance with, UL 5085-3/ CSA-C22.2 No. 66.3 or UL 1310/CSA-C22.2 No. 223). In order to respect the UL/CSA 61010 requirements, install the regulator inside a box, not in external environment.

If the equipment is used in a manner not specified by the manufacturer, the protection provided by the equipment may be impaired.
- The power supply voltage must be within the range of 24V±10%.
- The board implements a protection against overload of the reference signal.
- The M12 5 pin male connector has the following pinout

	Operation and maintenance instructions Series PME CANopen proportional pressure regulator	5000054187
		Ver. 01

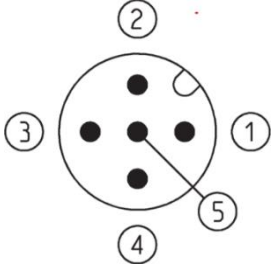





PIN	NAME	DESCRIPTION	SYMBOL
1	NC	Not connected	
2	V+	Power supply: connect to the positive pole of the power supply (referred to GND)	
3	GND	Ground (referred to pin 2): connect to the negative pole of the power supply	
4	CAN_H	CAN H bus line	
5	CAN_L	CAN L bus line	

N.B. For the electrical connection the following cable types are available:

CODE	DESCRIPTION
CS-LF05HB-D200	Overmolded connector M12 5 poles female straight 2 mt cable shielded
CS-LF05HB-D500	Overmolded connector M12 5 poles female straight 5 mt cable shielded
CS-LF05HB-C200	Overmolded connector M12 5 poles female straight 2 mt cable unshielded
CS-LF05HB-C500	Overmolded connector M12 5 poles female straight 5 mt cable unshielded
CS-LR05HB-D200	Overmolded connector M12 5 poles female angled 2 mt cable shielded
CS-LR05HB-D500	Overmolded connector M12 5 poles female angled 5 mt cable shielded
CS-LR05HB-C200	Overmolded connector M12 5 poles female angled 2 mt cable unshielded
CS-LR05HB-C500	Overmolded connector M12 5 poles female angled 5 mt cable unshielded
CS-AA08EC	4-ways T connector for BUS-IN and BUS-OUT
CS-AA05EC	3-ways T connector for BUS-IN and BUS-OUT

- Following some examples of electrical connections:

LEGEND:

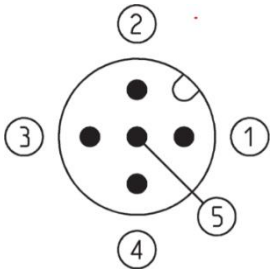
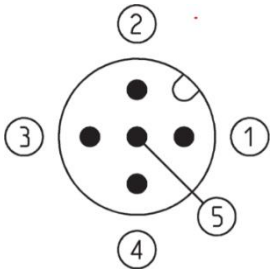
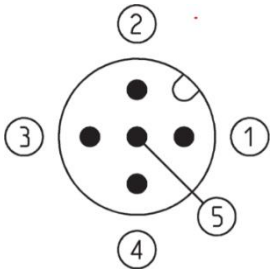
NAME	SYMBOL	NOTE																				
CANopen line		CANopen line: CAN_L; CAN_H, CAN_GND																				
Power line		Power line: V+; P_GND																				
Mixed line		CANopen line and Power line: CAN_L; CAN_H; V+; GND. Use the Camozzi cable CS-LF(R)05HB-D(C)2(5)00.																				
CS-AA05EC		3-ways T connector with 5way clamp																				
CS-AA08EC		4-ways T connector with 8way clamp																				
PME CANopen		<table border="1"> <thead> <tr> <th>PIN</th> <th>NOME</th> <th>DESCRIZIONE</th> <th>SIMBOLO</th> </tr> </thead> <tbody> <tr> <td>1</td> <td>NC</td> <td>Not connected</td> <td rowspan="6">  </td> </tr> <tr> <td>2</td> <td>V+</td> <td>Power supply: connect to the positive pole of the power supply (referred to GND)</td> </tr> <tr> <td>3</td> <td>GND</td> <td>Ground (referred to pin 2): connect to the negative pole of the power supply</td> </tr> <tr> <td>4</td> <td>CAN_H</td> <td>CAN H bus line</td> </tr> <tr> <td>5</td> <td>CAN_L</td> <td>CAN L bus line</td> </tr> </tbody> </table>	PIN	NOME	DESCRIZIONE	SIMBOLO	1	NC	Not connected		2	V+	Power supply: connect to the positive pole of the power supply (referred to GND)	3	GND	Ground (referred to pin 2): connect to the negative pole of the power supply	4	CAN_H	CAN H bus line	5	CAN_L	CAN L bus line
		PIN	NOME	DESCRIZIONE	SIMBOLO																	
		1	NC	Not connected																		
		2	V+	Power supply: connect to the positive pole of the power supply (referred to GND)																		
		3	GND	Ground (referred to pin 2): connect to the negative pole of the power supply																		
		4	CAN_H	CAN H bus line																		
5	CAN_L	CAN L bus line																				

a)

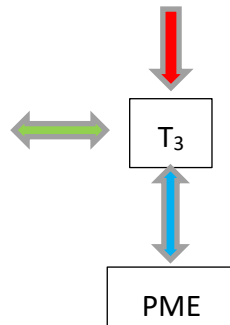

T ₃				
CANopen line	CAN_L	CAN_H	CAN_GND	
Power line			P_GND	V+
Mixed line	CAN_L	CAN_H	GND	V+

b)

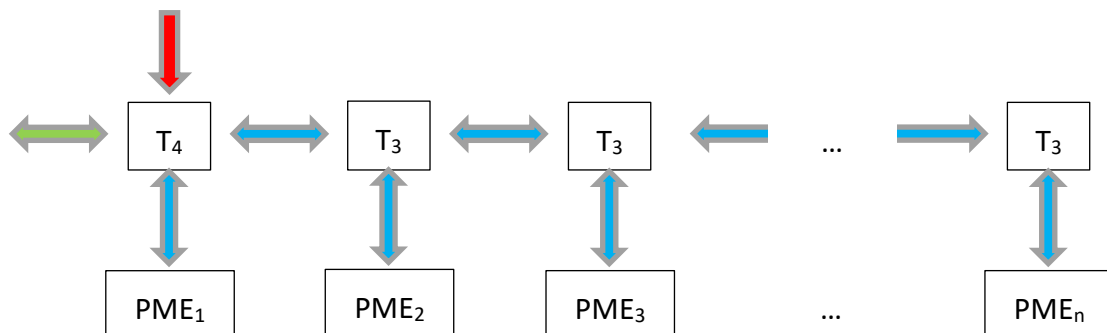

T ₄								
	1	2	3	4	5	6	7	8
CANopen line	CAN_L	CAN_H	CAN_GND					
Power line			P_GND	V+				
Mixed line	CAN_L	CAN_H	GND	V+				
Mixed line	CAN_L	CAN_H	GND	V+				
T ₃								
Mixed line	CAN_L	CAN_H	GND	V+				
Mixed line	CAN_L	CAN_H	GND	V+				
Mixed line	CAN_L	CAN_H	GND	V+				

c)

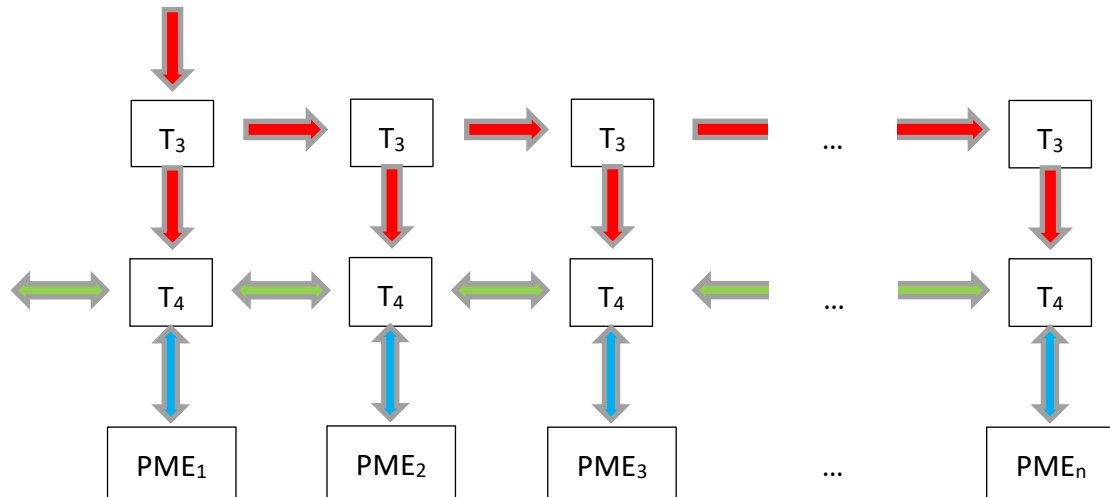

T ₄								
	1	2	3	4	5	6	7	8
CANopen line	CAN_L	CAN_H	CAN_GND					
Power line			P_GND	V+				
CANopen line	CAN_L	CAN_H	CAN_GND	CANopen line				
Mixed line	CAN_L	CAN_H	GND	V+				
T ₃								
Power line			P_GND	V+				
Power line			P_GND	V+				
Power line			P_GND	V+				

10. Device Configuration

NFCamApp is a configuration application that can be installed on android mobile device and available on Play Store.

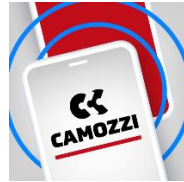

NFCamApp communicates with the Series PME electronic pressure regulator via NFC connection and is able to configure the device. The NFC antenna is located under the label with the product code.

Following the configurator of the Series PME electronic pressure regulator is described in detail. For installation and use of the NFCamApp, please refer to the dedicated manual.

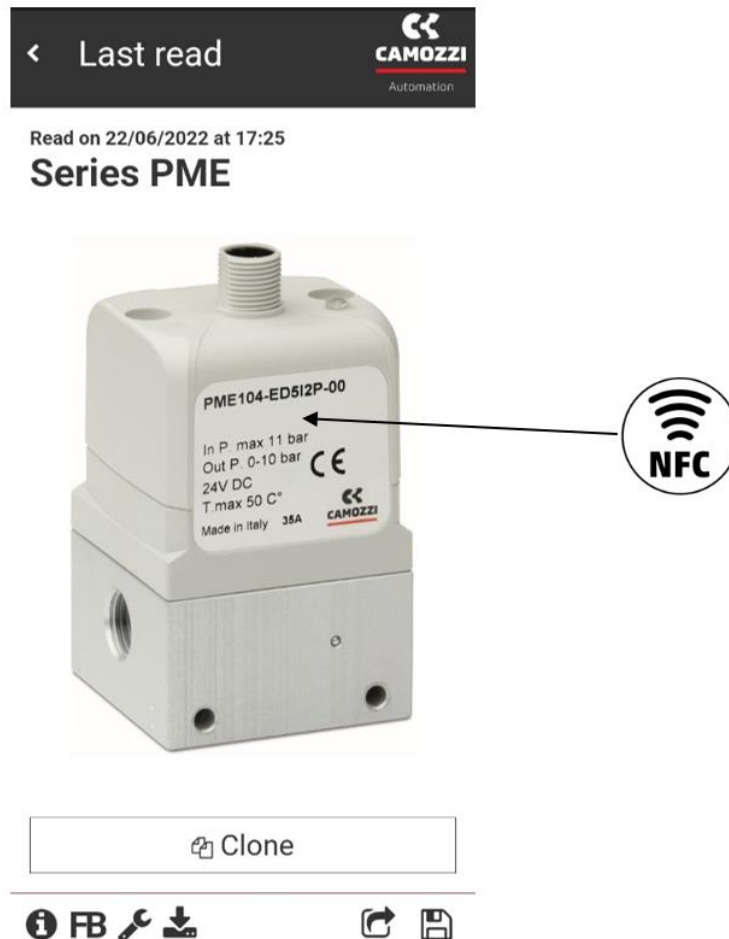

10.1. Information

This section () displays the information about selected device.

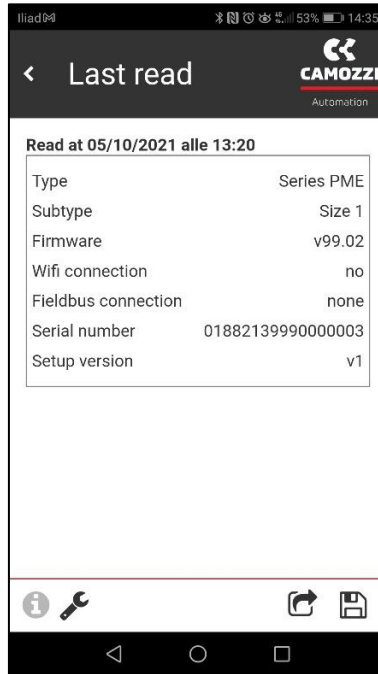

- *Type*: description of device type
- *Subtype*: description of device sub-type
- *Firmware*: firmware version
- *WiFi connection*: indicates if the WiFi connection is present (not available for the Series PME electronic pressure regulator)
- *Fieldbus*: indicates the fieldbus connection available (CANopen)
- *Serial number*: univocal serial number device assigned by producer.
- *Setup version*: internal memory mapping version.

10.2. Fieldbus

This section () displays the information about fieldbus configuration of the. device

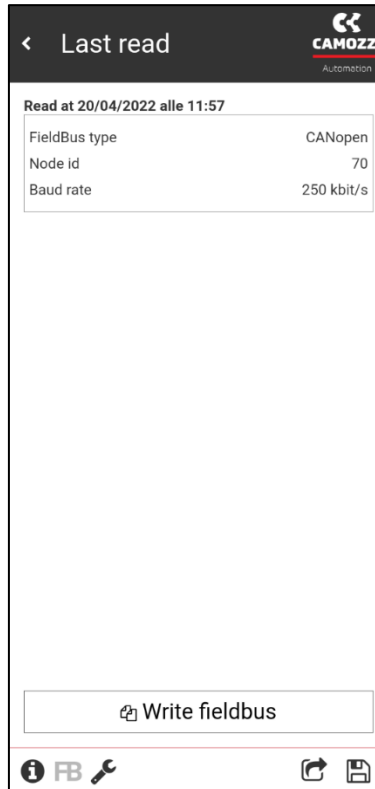

Parameters:

- Fieldbus type: these parameters un-editable indicates the fieldbus connection in use (CANopen).
- Node id: device's CANopen address.
- Baud rate: CANopen fieldbus baud rate.

By pressing the “Write fieldbus” button it is possible to modify and save the parameters of the CANopen network (node id and baud rate) in the memory.

10.3. Configurator

By clicking on the button  it is possible to open the configurator.

Two not editable parameters are showed:

- Set Point Signal: indicates the input type signal available (only CANopen).
- Commercial Code: commercial code of regulator

The editable parameters are divided into the following groups.

10.3.1. User setup

- **Pid Mode:** serves to set the PID gains according to the air volume used. The available values are: SET1 (SLOW, suitable for small volumes), SET2 (MEDIUM, suitable for medium volumes), SET3 (FAST, suitable for big volumes) or SET4 (CUSTOM).
- **Dead band:** when this parameter is set to a value higher than 0, the regulator will not make any adjustment as long as the absolute error of the regulated pressure (difference between the regulated pressure and the target pressure) remains lower than the set dead band value (red line).

On the other hand, when the absolute error of the regulated pressure exceeds the value of the set dead band, the regulator returns to carry out normal regulation (green line).

This operating mode makes it possible to avoid continuous adjustments by the regulator, increasing its life cycle. On the other hand, the achievement of the target pressure according to the declared performance is not guaranteed: the adjusted pressure error will depend directly on the dead band value set.

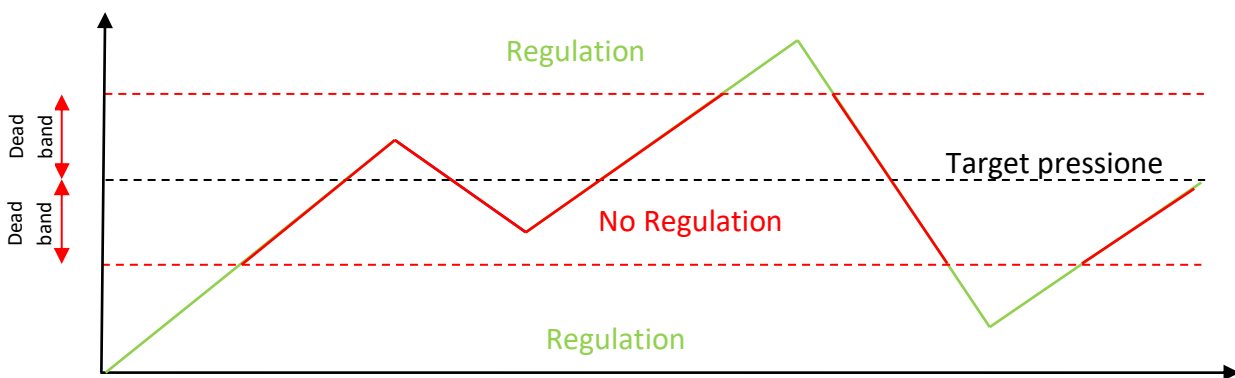

- **Protection Timeout:** sets the inactivity time of the regulator when the target pressure is not reached before the expiration of the Pressure regulation timeout. During the period of inactivity, the regulator maintains the current pressure without trying to reach the target pressure. After this inactivity time has expired, the regulator will try again to reach the target pressure. Use this parameter if you want to avoid that the regulator keeps the internal valves activated for too long, reducing their expected lifetime. If the parameter is 0, the function is disabled.
- **Internal sensor filter cutoff:** this parameter sets the cutoff frequency [Hz] of the digital filter applied to the internal sensor signal. Use this parameter to eliminate noise in the regulated pressure signal. A big value of this parameters increases the time response of the regulator. If the value of this parameter is 0, the filter is disabled.
- **Pressure regulation check mode:** Sets the type of event, warning or alarm, in case the regulated pressure doesn't reach the target value. See parameter "Pressure regulation check timeout". In the event of a warning, pressure regulation is not interrupted; on the other hand, in the event of an error, pressure regulation is interrupted.
- **Pressure regulation check timeout:** enables to control the regulated pressure. This control is similar to the "window" function of the digital output (for more details regarding this function, refer to paragraph "Digital output"): the regulator checks if the regulated pressure reaches the pressure target within a certain settable time (Pressure regulation timeout). This control uses the values "Negative window level" and "Positive window level" to determine the tolerance range on the regulated pressure.

- Pressure regulation timeout: serves to set the timeout value for the pressure regulation check. Refer to the “Enable pressure regulation check” parameter.
- Hysteresis value: available only if the dead band value is greater than 0. When the absolute error of the adjusted pressure (difference between the adjusted pressure and the target pressure) remains below the dead band value set for a sufficient time, the regulated pressure is considered stable and the hysteresis operating mode (A) is activated. If, on the other hand, the absolute error of the regulated pressure remains lower than the dead band value set for a NOT sufficient time, the regulated pressure is deemed NOT stable and the hysteresis operating mode (B) is NOT activated.

When the hysteresis operating mode is active, the regulator will not make any adjustment as long as the absolute error of the regulated pressure remains less than the value of the sum of the dead band and hysteresis values set (C).

When the absolute error of the regulated pressure exceeds the value of the sum of the dead band and hysteresis values set, the hysteresis operating mode is deactivated (D) and therefore the regulator will not carry out any regulation only if the absolute error of the regulated pressure becomes lower than the set dead band value (E). To reactivate the hysteresis operating mode, the absolute error of the regulated pressure must remain below the dead band value set for a sufficient time.

This operating mode allows to reach the target pressure with sufficient precision, according to the dead band value set, and to define a wider range, defined by the set hysteresis value, in which the regulator will not perform any regulation.

Compatibly with the application carried out by the regulator, it is recommended to set:

- the dead band value as small as possible, in order to obtain a good regulation precision of the regulated pressure
- the hysteresis value as large as possible, generally greater than the dead band value, in order to limit the number of actuations of the regulator.

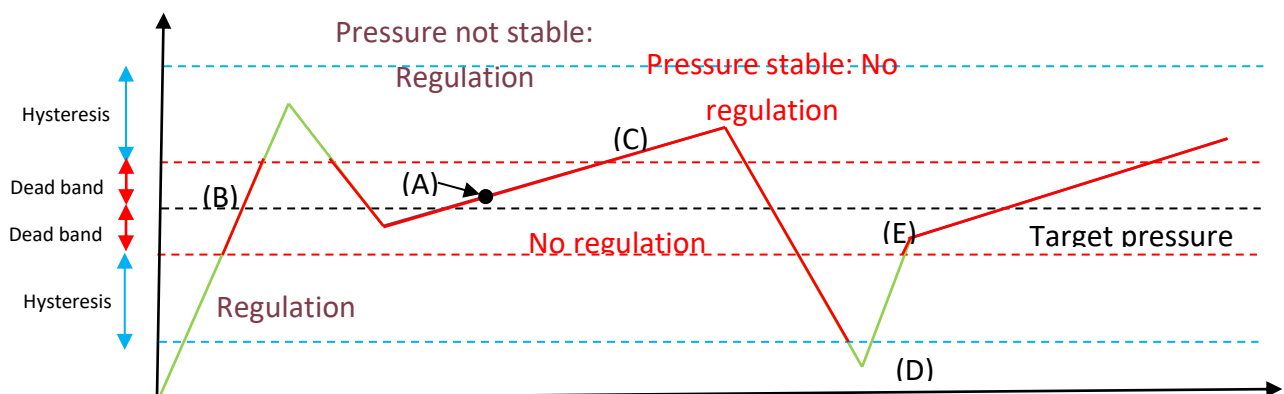

10.3.2. K parameters

This group is available only if Pid Mode SET4 (CUSTOM) is selected and contains the parameters in order to set the PID.

ATTENTION: the system could be instable if you use values too high. Increase carefully the K parameters values. Do not create a system instability. The mechanical and electronic internal components could be damage. Avoid continuously oscillations of regulator (you hear a hammered noise). In this case decrease the K parameters values in order to eliminate the oscillations.

Legend:

- KpUpCustom: proportional gain for upload coil
- KiUpCustom: integral gain for upload coil
- KdUpCustom: derivative gain for upload coil
- KpDownCustom: proportional gain for download coil
- KiDownCustom: integral gain for download coil
- KdDownCustom: derivative gain for download coil

10.3.3. Feedback setup

This group contains the parameters to set the digital output.

- Output Window control: this object enables the "Pressure Window" control on the regulated pressure, it can be 0 = Disable or 1 = Enable. With this operating mode it is possible to set two thresholds, a lower one and a higher one, which determine a pressure range with respect to the target pressure value : if the regulated pressure is outside the instantaneous range (it depends on the target pressure value at that moment) delimited by the two set thresholds, the regulator will signal the event with a warning, but it will not interrupt the regulation and the diagnostics will not change its status.

This is a useful way to verify that the regulated pressure is within a predetermined accuracy range or not.

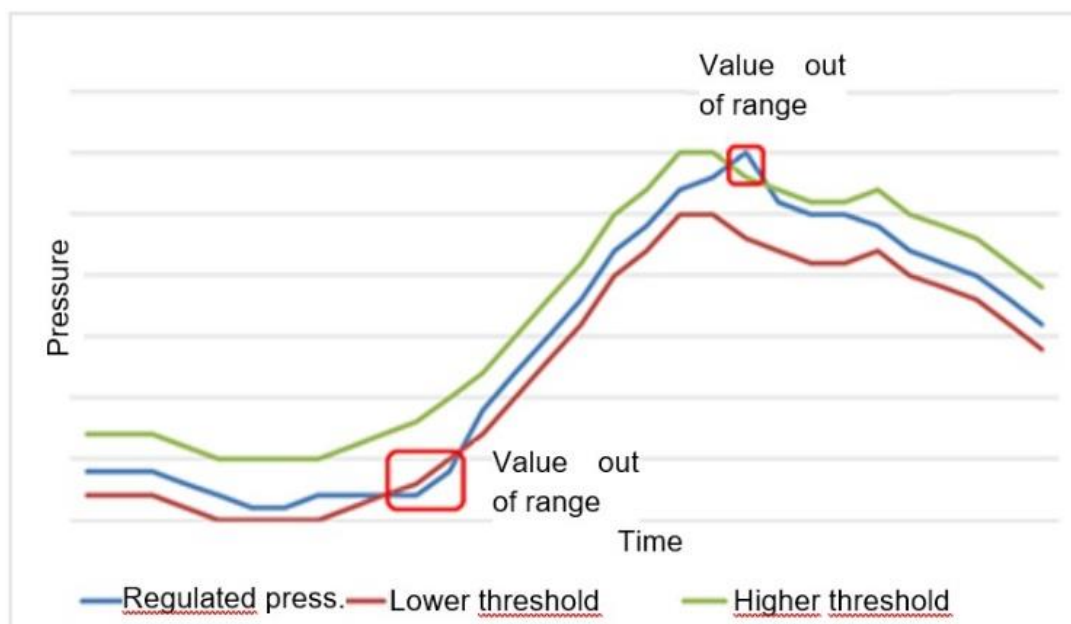

- Upper limit window control: sets the higher differential for the pressure window mode.
- Lower limit window control: sets the lower differential for the pressure window mode.
- Output Switch control: this object enables the "Pressure Switch" control on the pressure reading, it can be 0 = Disable or 1 = Enable. With this operating mode it is possible to set two fixed pressure thresholds, lower one and an upper one: if the regulated pressure is outside the range delimited by the two thresholds set, the Controller will signal the event with a warning, but will not interrupt the regulation. In this case the diagnostic led will not change its status. This is a useful way to verify that the regulated pressure is within a predetermined pressure range or not

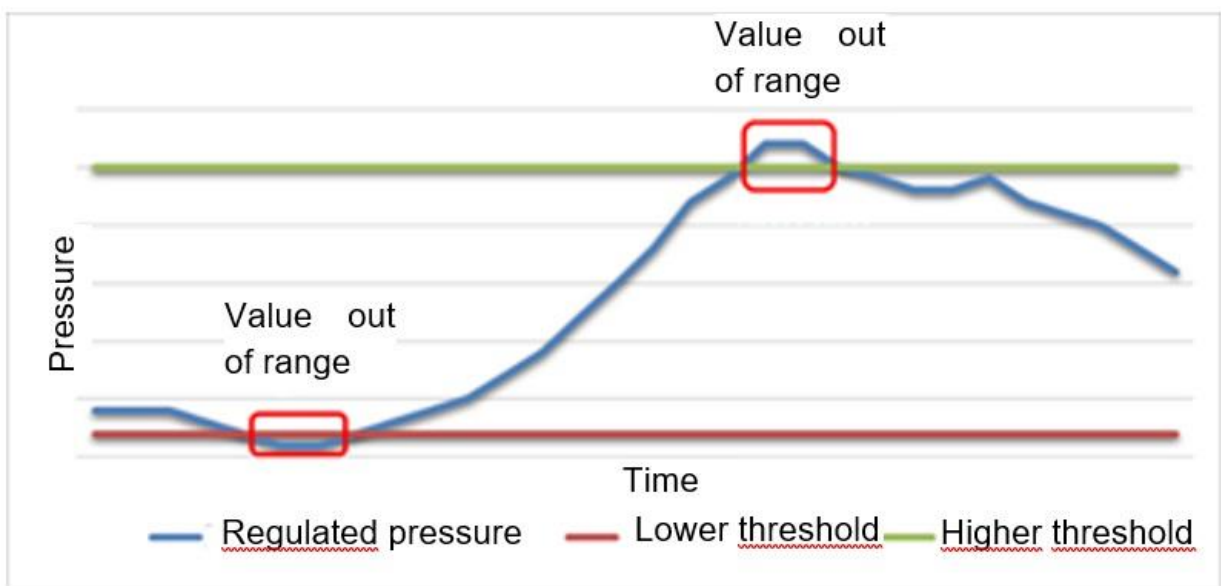

- Lower limit switch control: sets the lower threshold for the pressure switch mode.
- Upper limit switch control: sets the upper threshold for the s pressure witch mode.

10.3.4. Specific device setup

This group contains some parameters about fieldbus communication.

- CiA 408 profile: allows you to enable / disable the CiA 408 profile. If enabled, the operating status will follow the state machine specified in the profile with the use of objects 6040h Control Word and 6041h Status Word.
- Termination resistance: allows you to enable / disable the termination resistor inside the device. This object must be enabled if the regulator is the last node of the CANopen line. This enables a 120 ohm resistor in parallel to the CAN lines, as shown below.

	Operation and maintenance instructions Series PME CANopen proportional pressure regulator	5000054187
		Ver. 01

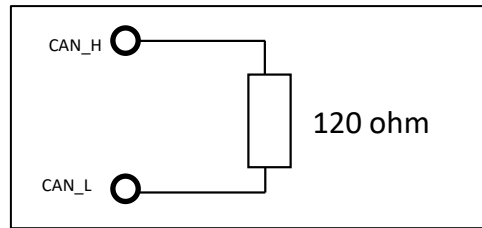

- Emergency message transmission: allows you to enable / disable the transmission of the emergency messages described in the CiA 301 profile. If the transmission is disabled, no acyclic diagnostic message will be generated, the errors will only be visible from the system LED and by reading the specific objects.

10.3.5. Password

By pressing the "Set new password" button you can enter a new password (up to 4 alphanumeric characters) which will be saved in the device memory. If you forget the customized password, it will no longer be possible to modify the regulator parameters (in this case, contact the Camozzi Service to reset the regulator password to the factory settings). The password is not required to view the parameters.

10.3.6. Saving parameters

All modified parameters (including the password) are saved in the regulator memory by pressing the "Write new parameters" button. The procedure requires entering the regulator password. The factory password is "0000".

11. CANopen pressure regulator

11.1. Configuration via EDS file

To configure the PME in a CANopen network it is necessary to import the EDS file. The configuration file describes the characteristics of the CANopen controller and its configuration. The EDS file is available on the Camozzi website at the following address:

<http://catalogue.camozzi.com/Downloads>

11.2. Address and baud rate

The PME CANopen must have a unique address (range 1 - 127) to be correctly identified on the network and the communication speed (Baud rate) must be set.

To connect the PME to the CANopen bus use a five-pole cable and preferably shielded. The maximum length of the CANopen line depends on the baud rate (transmission speed) used as indicated in the following table.

BAUD RATE [kbits/s]	MAXIMIMUM LENGHT OF THE SEGMENT [m]
10	5000
20	2500
50	1000
125	500
250	250
500	100
800	50
1000	25

	Operation and maintenance instructions Series PME CANopen proportional pressure regulator	5000054187
		Ver. 01

11.3. Object dictionary

The objects are defined by CiA 301 profile, by CiA 408 profile and by customer objects.

11.3.1. CiA 301 profile objects

ID	SUB	DESCRIPTION	TYPE	ACCESS	PDO MAPPING	DEFAULT VALUE
1000h	0	Device Type	U32	RO		0x21000198
1001h	0	Error register	U8	RO	X	0x0
1002h	0	Manufacturer status register	U32	RO	X	0x0
1003h		Pre defined error list				
	0	Number of errors	U32	RW		0x0
	1	Standard error field	U32	RO		0x0
	2	Standard error field	U32	RO		0x0
	3	Standard error field	U32	RO		0x0
	4	Standard error field	U32	RO		0x0
	5	Standard error field	U32	RO		0x0
	6	Standard error field	U32	RO		0x0
	7	Standard error field	U32	RO		0x0
	8	Standard error field	U32	RO		0x0
1005h	0	COB_ID sync	U32	RW		0x80
1006h	0	Communication Cycle Period	U32	RW		0x0
1007h	0	Synchronous Window Length	U32	RW		0x0
1008h	0	Manufacturer device name	STR	CONST		PME
1009h	0	Manufacturer hardware version	STR	CONST		0x1
100Ah	0	Manufacturer software version	STR	CONST		0x0
100Ch	0	Guard time	U16	RW		0x0
100Dh	0	Life time factor	U16	RW		0x0
1010h		Store parameter field				
	0	Highest sub-index supported	U32	RO		0x3
	1	Save all parameters	U32	RW		0x0
	2	Save communication parameters	U32	RW		0x0
	3	Save application parameters	U32	RW		0x0

ID	SUB	DESCRIPTION	TYPE	ACCESS	PDO MAPPING	DEFAUL VALUE
1011h		Restore default parameters				
	0	Highest sub-index supported	U32	RO		0x3
	1	Restore all default parameters	U32	RW		0x0
	2	Restore communication parameters	U32	RW		0x0
	3	Restore application parameters	U32	RW		0x0
1012h	0	COB-ID time stamp	U32	RW		0x80000100
1014h	0	COB_ID emcy	U32	RO		0x80
1015h	0	Inhibit time emergency	U16	RW		0x0
1017h	0	Producer heartbeat time	U16	RW		0x0
1018h		Identity object				
	0	Number of entries	U8	RO		0x4
	1	Vendor id	U32	RO		0x97
	2	Product code	U32	RO		0X0000005C
	3	Revision number	U32	RO		0x1
	4	Serial number	U32	RO		0x0
1019h	0	Synchronous counter overflow value	U8	RW		0x0
1029h		Error behaviour				
	0	Highest sub-index supported	U8	RO		0x1
	1	Communication error	U8	RW		0x0
1200h		Server SDO parameter				
	0	Highest sub-index supported	U8	RO		0x2
	1	COIB-ID client->server	U32	RO		0x600
	2	COIB-ID server->client	U32	RO		0x580
1400h		Rx PDO communication parameter 1				
	0	Highest sub-index supported	U8	RO		0x2
	1	COB-ID	U32	RW		0x200
	2	Transmission type	U8	RW		0xFF
1401h		Rx PDO communication parameter 2				

ID	SUB	DESCRIPTION	TYPE	ACCESS	PDO MAPPING	DEFAULT VALUE
	0	Highest sub-index supported	U8	RO		0x2
	1	COB-ID	U32	RW		0x80000300
	2	Transmission type	U8	RW		0xFF
1402h		Rx PDO communication parameter 3				
	0	Highest sub-index supported	U8	RO		0x2
	1	COB-ID	U32	RW		0x80000400
	2	Transmission type	U8	RW		0xFF
1403h		Rx PDO communication parameter 4				
	0	Highest sub-index supported	U8	RO		0x2
	1	COB-ID	U32	RW		0x80000500
	2	Transmission type	U8	RW		0xFF
1404h		Rx PDO communication parameter 5				
	0	Highest sub-index supported	U8	RO		0x2
	1	COB-ID	U32	RW		0x80000000
	2	Transmission type	U8	RW		0xFF
1405h		Rx PDO communication parameter 6				
	0	Highest sub-index supported	U8	RO		0x2
	1	COB-ID	U32	RW		0x80000000
	2	Transmission type	U8	RW		0xFF
1406h		Rx PDO communication parameter 7				
	0	Highest sub-index supported	U8	RO		0x2
	1	COB-ID	U32	RW		0x80000000
	2	Transmission type	U8	RW		0xFF
1407h		Rx PDO communication parameter 8				
	0	Highest sub-index supported	U8	RO		0x2
	1	COB-ID	U32	RW		0x80000000
	2	Transmission type	U8	RW		0xFF
1600h		Rx PDO mapping parameter 1				

ID	SUB	DESCRIPTION	TYPE	ACCESS	PDO MAPPING	DEFAULT VALUE
	0	Number of mapped objects	U8	RW		0x2
	1	Mapping entry 1	U32	RW		0x60400010
	2	Mapping entry 2	U32	RW		0x63800110
	3	Mapping entry 3	U32	RW		0x0
	4	Mapping entry 4	U32	RW		0x0
	5..8	Mapping entry X	U32	RW		0x0
1601h		Rx PDO mapping parameter 2				
	0	Number of mapped objects	U8	RW		0x0
	1..8	Mapping entry X	U32	RW		0x0
1602h		Rx PDO mapping parameter 3				
	0	Number of mapped objects	U8	RW		0x0
	1..8	Mapping entry X	U32	RW		0x0
1603h		Rx PDO mapping parameter 4				
	0	Number of mapped objects	U8	RW		0x0
	1..8	Mapping entry X	U32	RW		0x0
1604h		Rx PDO mapping parameter 5				
	0	Number of mapped objects	U8	RW		0x0
	1..8	Mapping entry X	U32	RW		0x0
1605h		Rx PDO mapping parameter 6				
	0	Number of mapped objects	U8	RW		0x0
	1..8	Mapping entry X	U32	RW		0x0
1606h		Rx PDO mapping parameter 7				
	0	Number of mapped objects	U8	RW		0x0
	1..8	Mapping entry X	U32	RW		0x0
1607h		Rx PDO mapping parameter 8				
	0	Number of mapped objects	U8	RW		0x0
	1..8	Mapping entry X	U32	RW		0x0
1800h		Tx PDO communication parameter 1				
	0	Sub-index supported	U8	RO		0x5
	1	COIB-ID	U32	RW		0x180
	2	Transmission type	U8	RW		0xFF

ID	SUB	DESCRIPTION	TYPE	ACCESS	PDO MAPPING	DEFAULT VALUE
	3	Inhibit time	U16	RW		0x3E8
	4	Compatibility entry	U8	RW		0x0
	5	Event timer	U16	RW		0x0
1801h		Tx PDO communication parameter 2				
	0	Sub-index supported	U8	RO		0x5
	1	COIB-ID	U32	RW		0x80000280
	2	Transmission type	U8	RW		0xFF
	3	Inhibit time	U16	RW		0x0
	4	Compatibility entry	U8	RW		0x0
	5	Event timer	U16	RW		0x0
1802h		Tx PDO communication parameter 3				
	0	Sub-index supported	U8	RO		0x5
	1	COIB-ID	U32	RW		0x80000380
	2	Transmission type	U8	RW		0xFF
	3	Inhibit time	U16	RW		0x0
	4	Compatibility entry	U8	RW		0x0
	5	Event timer	U16	RW		0x0
1803h		Tx PDO communication parameter 4				
	0	Sub-index supported	U8	RO		0x5
	1	COIB-ID	U32	RW		0x80000480
	2	Transmission type	U8	RW		0xFF
	3	Inhibit time	U16	RW		0x0
	4	Compatibility entry	U8	RW		0x0
	5	Event timer	U16	RW		0x0
1804h		Tx PDO communication parameter 5				
	0	Sub-index supported	U8	RO		0x5
	1	COIB-ID	U32	RW		0x80000000
	2	Transmission type	U8	RW		0xFF
	3	Inhibit time	U16	RW		0x0

ID	SUB	DESCRIPTION	TYPE	ACCESS	PDO MAPPING	DEFAULT VALUE
	4	Compatibility entry	U8	RW		0x0
	5	Event timer	U16	RW		0x0
1805h		Tx PDO communication parameter 6				
	0	Sub-index supported	U8	RO		0x5
	1	COIB-ID	U32	RW		0x80000000
	2	Transmission type	U8	RW		0xFF
	3	Inhibit time	U16	RW		0x0
	4	Compatibility entry	U8	RW		0x0
	5	Event timer	U16	RW		0x0
1806h		Tx PDO communication parameter 7				
	0	Sub-index supported	U8	RO		0x5
	1	COIB-ID	U32	RW		0x80000000
	2	Transmission type	U8	RW		0xFF
	3	Inhibit time	U16	RW		0x0
	4	Compatibility entry	U8	RW		0x0
	5	Event timer	U16	RW		0x0
1807h		Tx PDO communication parameter 8				
	0	Sub-index supported	U8	RO		0x5
	1	COIB-ID	U32	RW		0x80000000
	2	Transmission type	U8	RW		0xFF
	3	Inhibit time	U16	RW		0x0
	4	Compatibility entry	U8	RW		0x0
	5	Event timer	U16	RW		0x0
1A00h		Tx PDO mapping parameter 1				
	0	Number of mapped objects	U8	RW		0x2
	1	Mapping entry 1	U32	RW		0x60410010
	2	Mapping entry 2	U32	RW		0x63810110
	3..8	Mapping entry X	U32	RW		0X0
1A01h		Tx PDO mapping parameter 2				
	0	Number of mapped objects	U8	RW		0x0

ID	SUB	DESCRIPTION	TYPE	ACCESS	PDO MAPPING	DEFAULT VALUE
	1..8	Mapping entry X	U32	RW		0x0
1A02h		Tx PDO mapping parameter 3				
	0	Number of mapped objects	U8	RW		0x0
	1..8	Mapping entry X	U32	RW		0x0
1A03h		Tx PDO mapping parameter 4				
	0	Number of mapped objects	U8	RW		0x0
	1..8	Mapping entry X	U32	RW		0x0
1A04h		Tx PDO mapping parameter 5				
	0	Number of mapped objects	U8	RW		0x0
	1..8	Mapping entry X	U32	RW		0x0
1A05h		Tx PDO mapping parameter 6				
	0	Number of mapped objects	U8	RW		0x0
	1..8	Mapping entry X	U32	RW		0x0
1A06h		Tx PDO mapping parameter 7				
	0	Number of mapped objects	U8	RW		0x0
	1..8	Mapping entry X	U32	RW		0x0
1A07h		Tx PDO mapping parameter 8				
	0	Number of mapped objects	U8	RW		0x0
	1..8	Mapping entry X	U32	RW		0x0
1F80h	0	NMT startup	U32	RW		0x4

	Operation and maintenance instructions Series PME CANopen proportional pressure regulator	5000054187
		Ver. 01

11.3.2. CiA 301 profile objects description

11.3.2.1. 1000h Device type

This object contains information about the device type and its functionality. It consists of two 16-bit fields: the first one describes the profile used and the second one contains specific additional information.

11.3.2.2. 1001h Error register

This object contains the internal device error mapping, is a mandatory object for all devices and is included in the emergency objects. The defined values are defined in the following table.

BIT	OPZIONALE	DESCRIZIONE
0	Mandatory	Generic error
1	Optional	Current
2	Optional	Voltage
3	Optional	Temperature
4	Optional	Communication error
5	Optional	Specific of profile
6	Optional	Reserved
7	Optional	Reserved

11.3.2.3. 1002h Manufacturer status register

This object contains the status of the device, it is specific to the manufacturer

11.3.2.4. 1003h Pre-defined error field

This object contains errors that have occurred on the device and that have been reported by the emergency message. Doing so, it provides a history.

Sub-index 0 contains the number of errors that are currently saved from sub-index 1 to sub-index 8. When there are no errors, it contains the value zero. Each new error is saved at index 1 and the old ones are moved to the major indices.

Writing zero on sub-index 0 involves deleting the history, resetting all saved errors.

Each error consists of a 16-bit field that contains the error code, defined by CANopen.

MANUFACTURER INFORMATION	ERROR TYPE
0x0000	No error
0x2320	Overcurrent coil error
0x3120	Master power supply too low error

	Operation and maintenance instructions Series PME CANopen proportional pressure regulator	5000054187
		Ver. 01

0x4210	Device temperature error
0x5530	Memory error
0x5220	Micro error
0x8302	Pressure error
0x5410	Driver error

11.3.2.5. 1005h COB-ID sync

This object contains the configuration of the COB-ID of the synchronization message (SYNC), it indicates whether the device generates the message or not.

BIT	VALUE	DESCRIPTION
31(MSB)	X	Not used
30	0 1	The device does not generate the SYNC message The device generates the SYNC message
29	0 1	11-bit CAN-ID 29-bit CAN-ID
28-0	X	Extended address 29 bit
11-0	X	Standard address 11 bit

11.3.2.6. 1006h Communication cycle period

This object contains the period in milliseconds of the cyclic communication of SYNC messages, when its value is null the device does not send synchronism messages.

11.3.2.7. 1007h Synchronous window length

This object the time from the synchronism message within which these PDOs must arrive to be valid. If the value is set to zero, the synchronization is disabled.

11.3.2.8. 1008h Manufacturer device name

This object contains the device name given by the manufacturer.

11.3.2.9. 1009h Manufacturer hardware version

This object contains the hardware version of the device.

11.3.2.10. 100Ah Manufacturer software version

This object contains the firmware version of the device.

	Operation and maintenance instructions Series PME CANopen proportional pressure regulator	5000054187
		Ver. 01

11.3.2.11. 100Ch Guard time

This object and the next 100Dh represent the configuration of the *life guarding* protocol. The *Guard time* parameter contains the period with which the *guarding* message is sent, it is expressed in ms, if it is set to zero the *life guarding* protocol is disabled.

11.3.2.12. 100Dh Life time factor

This object contains the number of *guarding* messages that can be lost. This value multiplied by the *Guard time* value is the maximum time in which the *guarding* messages must arrive in order not to generate an error and reset the communication.

11.3.2.13. 1010h Store parameter field

This object controls the saving of parameters in the permanent memory. With read access, the device provides information on its saving capacity.

Several groups of parameters are available:

- The sub-index 00h contains the highest sub-index supported.
- The sub-index 01h refers to all parameters that can be saved in the CANopen device.

11.3.2.14. 1011h Restore default parameter

This object involves resetting of the default parameters. Through a reading operation, the device communicates information regarding the ability to restore these values. Many groups of parameters are available. To restore the default values, the load signal (00x64616f6c) must be written.

Different sub-indices reset different parameters as following indicated:

- Sub-index 1: all parameters.

11.3.2.15. 1012h COIB-ID time stamp

This object contains the configuration of the *time stamp* message (TIME), and it indicates whether the device consumes or produces the message.

BIT	VALUE	DESCRIPTION
31(MSB)	0	The device doesn't consume TIME message
	1	The device consumes TIME message
30	0	The device doesn't produce TIME message
	1	The device produces TIME message
29	0	11-bit CAN-ID
	1	29-bit CAN-ID
28-0	X	Extended address 29 bit
11-0	X	Standard address 11 bit

	Operation and maintenance instructions Series PME CANopen proportional pressure regulator	5000054187
		Ver. 01

11.3.2.16. 1014h COIB-ID EMCY

This object contains the configuration of the EMCY service

BIT	VALUE	DESCRIPTION
31(MSB)	0	EMCY exist / is valid
	1	EMCY don't exist / isn't valid
30	0	Reserved
29	0	11-bit CAN-ID
	1	29-bit CAN-ID
28-0	X	Extended address 29 bit
11-0	X	Standard address 11 bit

11.3.2.17. 1015h Inhibit time emergency

This object contains the inhibition time of the EMCY message, it must be a multiple of 100 μ s. If set to zero it disables the inhibition time

11.3.2.18. 1017h Producer heartbeat time

This object contains the configuration of the *heartbeat* protocol, it indicates the period in which the *heartbeat* message is produced. The period must be a multiple of 1 ms, if set to zero, the *heartbeat* management is disabled

11.3.2.19. 1018h Identity object

This object contains the information about the device:

SUB-INDEX	VALUE	DESCRIPTION
0	4	Sub-index number
1	151h	Vendor ID
2	05Ch	Product code
3	001h	Revision number
4	000h	Serial number

11.3.2.20. 1019h Synchronous counter overflow value

This object contains the SYNC message configuration. If the value is zero the SYNC message will have no parameters, if the value is between 2 and 240 then the SYNC message will have a parameter byte, which will contain a counter.

11.3.2.21. 1029h Error behaviour

This object contains the type of error that can occur. Sub-index 0 contains the number of errors class, sub-index 1 contains the communication error, sub-index 2 to 254 should contain errors specified by the CANopen profile or errors defined by the manufacturer.

Error classes can be:

- 0, preoperational.
- 1, the change of state event doesn't appear.
- 2, stopped.
- 3 – 127, reserved.

11.3.2.22. 1200h Server SDO parameter 1

The number of supported entities of objects in the SDO object record is specified in the sub-index 00h. In this device the values at subindex 01h and 02h specify the COB-ID for this SDO.

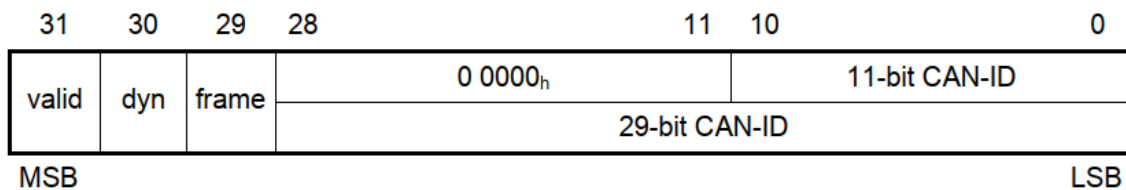

11.3.2.23. 1400h – 1407h Receive PDO Communication Parameter

These objects contain the communication configuration of the PDOs that the device can receive. The parameters of the PDO transmission are described in the document CIA301 section 7.4.8.1.

Sub-index 1 contains the COB-ID of the PDO:

BIT	VALUE	DESCRIPTION
31 (MSB)	0	PDO exist / is valid
	1	PDO don't exist / isn't valid
30	x	Reserved
29	0	11 bit CAN-ID
	1	29 bit CAN-ID
29-11		29 bit CAN-ID (extended message)
10-0		11 bit CAN-ID (standard message)

Sub-index 1 contains the transmission type:

- Value = 0 Synchronous transmission (with SYNC messages).
- Value = 1÷240 Synchronous transmission every N SYNC messages.
- Value = 252-253 Transmission only on transmission request (RTR).
- Value = 254 Customer specific asynchronous transmission.
- Value = 255 Device profile specific asynchronous transmission.

11.3.2.24. 1600h – 1607h Receive PDO Mapping Parameter

These objects contain the PDO mapping that the device is able to receive.

The sub-index 0 contains the number of objects mapped in the PDO, if the value is set to 0 no object is mapped. Each sub-index from 1 to the number specified above contains the information of the object mapped in the PDO.

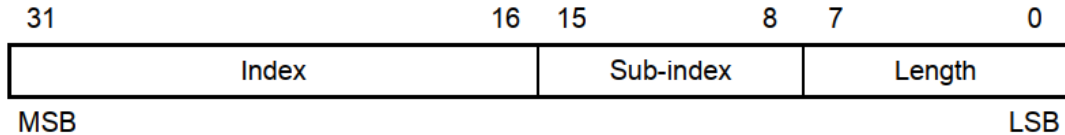

Following the sequence to modify the mapping of a PDO:

- Disable the Rx PDO by setting bit 31 in sub-index 1 of the RPDO communication parameter to value 1.
- Disable the existing mapping by setting sub-index 0 to zero.
- Change the mapping by changing the value of the corresponding sub-index.
- Enable mapping by setting sub-index 0 with the number of mapped objects.
- Enable the Rx PDO by setting bit 31 in sub-index 1 of the RPDO communication parameter to the value 0.

11.3.2.25. 1800h – 1807h Transmit PDO Communication Parameter

These objects contain the communication configuration of the PDOs that the device can transmit. The parameters of the PDO transmission are described in the document CIA301 section 7.4.8.1. Sub-index 1 contains the COB-ID of the PDO.

BIT	VALUE	DESCRIPTION
31 (MSB)	0	PDO exist / is valid
	1	PDO don't exist / isn't valid
30	0	RTR supported
	1	RTR not supported
29	0	11 bit CAN-ID
	1	29 bit CAN-ID
29-11		29 bit CAN-ID (extended message)
10-0		11 bit CAN-ID (standard message)

Sub-index 2 contains the communication type:

- Value = 0 Synchronous transmission (with SYNC messages).
- Value = 1÷240 Synchronous transmission every N SYNC messages.
- Value = 252-253 Transmission only on transmission request (RTR).
- Value = 254 Customer specific asynchronous transmission.
- Value = 255 Device profile specific asynchronous transmission

Sub-index 3 contains the minimum time interval with which the TPDO can be transmitted when the type of transmission set is 255 or 254. This value is a multiple of 100 μ s, if it is set to zero the minimum interval is disabled.

Sub-index 4 is reserved.

Sub-index 5 contains the maximum time interval with which the TPDO is transmitted when the type of transmission set is 255 or 254. This value is a multiple of 1 ms, if it is set to zero the maximum interval is disabled.

11.3.2.26. 1A00h – 1A07h Transmit PDO Mapping Parameter

Same as for RxPDO mapping.

11.3.2.27. 1F80h NMT Startup

This object contains the configuration of the master's *startup* behaviour, the bit description of its value is described in the following image

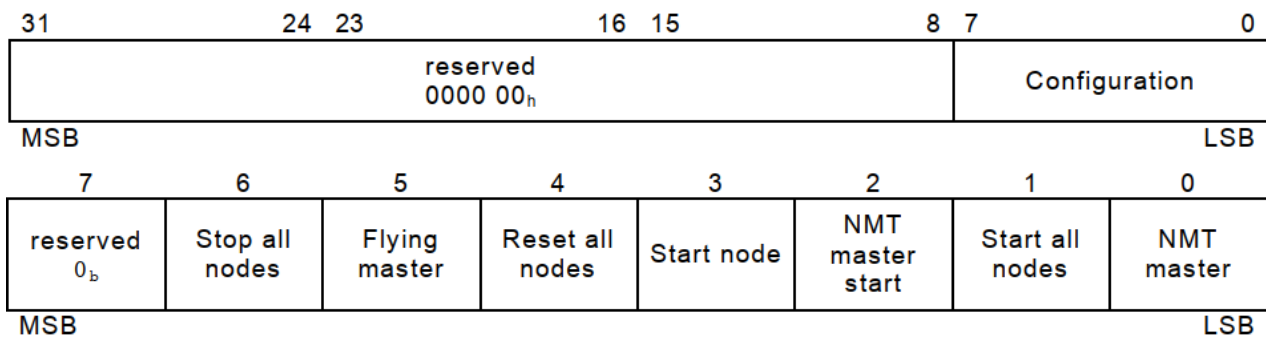

The drive allows you to modify bit 2 NMT *master start*:

- 0 = Allows the device to go into the operating state autonomously at *startup*.
- 1 = Does not allow the device to pass autonomously into the operating state.

The drive allows you to change bit 3 Start node also:

- 0 = The master must send the device in the operating state.
- 1 = the device goes into the operational state immediately upon startup.

An attempt to set a bit not managed by the device returns an object write abort error.

	Operation and maintenance instructions Series PME CANopen proportional pressure regulator	5000054187
		Ver. 01

11.4. CiA 408 profile objects

The CiA 408 profile specifies the CANopen interface for hydraulic proportional valves, hydrostatic pumps and hydrostatic transmissions (e.g. drive, axis) and may also be applied to pneumatic devices. The profile specifies the required configuration parameters, application parameters (process data), and diagnostic information. Parameters for hydraulic drive and valve (pump) reside in the same CANopen logical device. This allows one electronic circuit to control up to eight hydraulic drive and valve (pump) modules.

11.4.1. CiA 408 profile objects description

ID	SUB	DESCRIPTION	TYPE	ACCESS	PDO MAPPING	DEFAULT VALUE
6040h	0	Control Word	U16	RW	X	0x0
6041h	0	Status Word	U16	RW	X	0x0
6042h	0	Device Mode	I8	RO		0x1
6043h	0	Device Control Mode	I8	CONST		0x4
604Fh	0	Device Local	I8	RO		0x0
		VPRC Setpoint				
6380h	0	Highest sub-index supported	I16	CONST		0x1
	1	Setpoint Value	I16	RW	X	0x0
		VPRC Actual Value				
6381h	0	Highest sub-index supported	I16	CONST		0x1
	1	Actual Value	I16	RW	X	0x0

11.4.1.1. 6040h Control Word

This object controls the status and operation of the regulator only if the 2015h object is enabled. It is used to enable / disable pressure regulation. This object together with the object 6041h "Statusword" are used for the advancement of the state machine (FSA) of the CiA408 profile, refer to the relative CiA408 manual. The state machine (FSA: Finite State Automaton) is summarized by the following image:

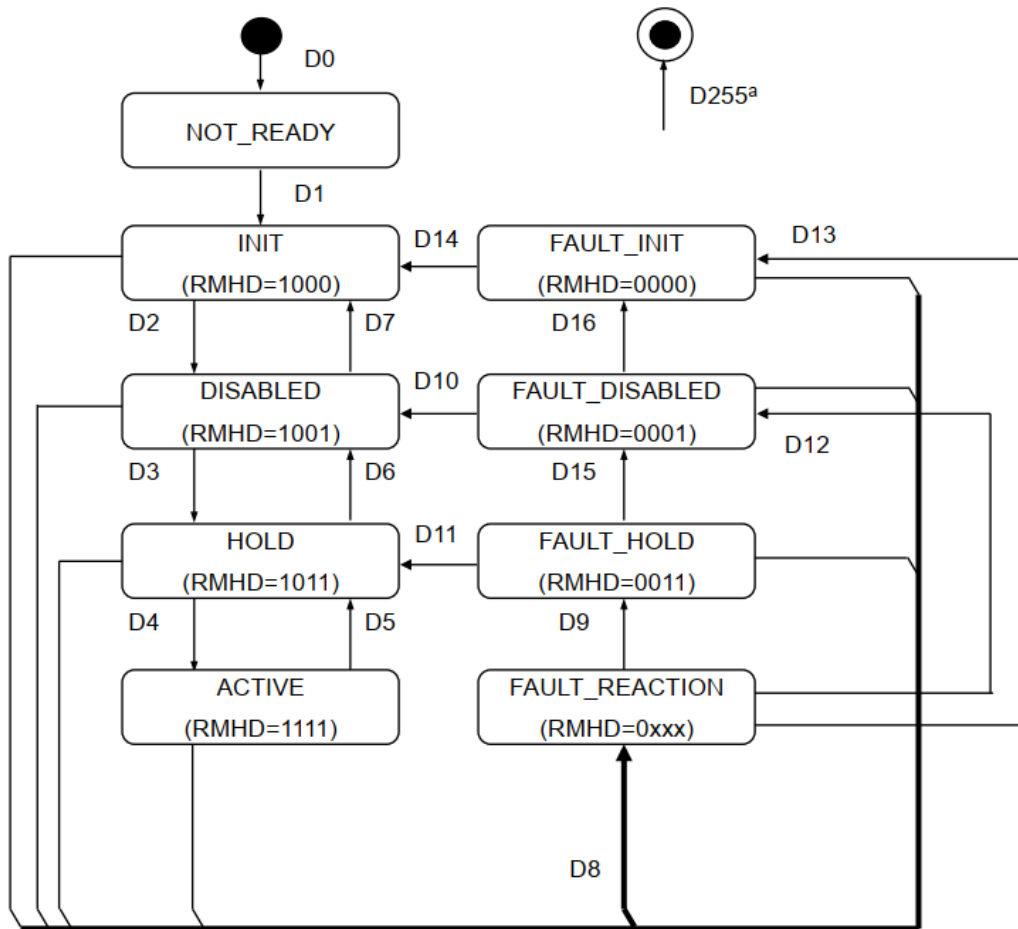

Key

- D1 to D13 and D255 (NOTE) – Device state transitions;
- x – Do not care bit. The value is equal either 0 or 1;
- R – Status word READY indicates the state INIT (bit 3);
- M – Status word device mode ACTIVE enable (bit 2);
- H – Status word HOLD activated (bit 1);
- D – Status word DISABLED (bit 0).

^a D255 may be reached from any other state in the device state machine.

The word is divided into bits with the following meanings:

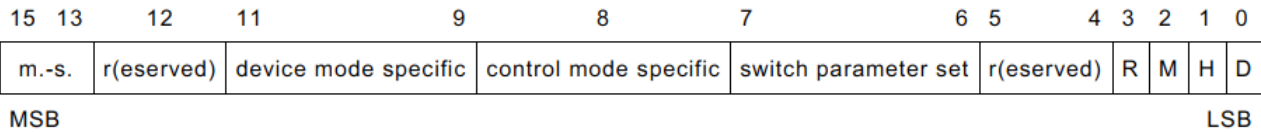

The available commands to change the drive status are summarized in the following table:

Transition	Control Word								Description
	7	6	5	4	3	2	1	0	
					R	M	H	D	
D2	X	X	X	X	X	X	X	1	Activate state DISABLED
D3	X	X	X	X	X	X	1	1	Activate state HOLD
D4	X	X	X	X	X	1	1	1	Activate state ACTIVE
D5	X	X	X	X	X	0	X	X	Deactivate state ACTIVE
D6	X	X	X	X	X	0	0	X	Deactivate state HOLD
D7	X	X	X	X	X	0	0	0	Deactivate state DISABLED
D10	X	X	X	X	0	0	0	1	Reset state FAULT_DISABLED
	To								
	X	X	X	X	1	0	0	1	
D11	X	X	X	X	0	0	1	1	Reset state FAULT_HOLD
	To								
	X	X	X	X	1	0	1	1	
D12	X	X	X	X	0	0	0	1	Reset state FAULT_REACTION Activate state FAULT_DISABLED
D13	X	X	X	X	0	0	0	0	Reset state FAULT_REACTION Activate state FAULT_INIT
D14	X	X	X	X	0	0	0	0	Reset State FAUT_INIT
	To								
	X	X	X	X	1	0	0	0	
D15	X	X	X	X	X	0	0	1	Transit from state FAULT_HOLD to state FAULT_DISABLED
D16	X	X	X	X	X	0	0	0	Transit from state FAULT_DISABLED to state FAULT_INIT

	Operation and maintenance instructions Series PME CANopen proportional pressure regulator	5000054187
		Ver. 01

11.4.1.2. 6041h Status Word

This object, in read-only mode, represents the current state in which the controller is located. It contains valid data only if the 2015h object is enabled.

The word is divided into bits with the following meanings:

15	13	12	11	10	9		7	6	5	4	3	2	1	0
m.-s.	RT	ce	It	control mode specific			r(eserved)	W	L	R	M	H	D	
MSB											LSB			

- m. -s. = enables manufacturer-specific control (1 enabled, 0 disabled)
- RT = target reached (1 target reached, 0 target not reached)
- ce = control Error (1 enabled, 0 disabled)
- it = the setpoint is limited by a function (1 limited, 0 not limited)
- control mode specific
- w = warning (1 enable, 0 disable)
- L = local control (1 locally controlled, 0 controlled via bus)
- R = ready (1 ready, 0 not ready)
- M = device mode active enable (1 enable, 0 disabled)
- H = hold enable (1 enable, 0 disabled)
- D = disabled (1 the device functions are enabled; 0 the device functions are disabled)

11.4.1.3. 6042h Device Mode

This object contains the indication from where the setpoint is received. In the controller it is a constant with a value of 1. This indicates that the setpoint is always taken via the bus.

11.4.1.4. 6043h Device control Mode

This object contains the way the device works. The regulator has only one possibility, therefore the content of this object is constant and equal to 4. This indicates that the device controls the pressure in closed loop.

11.4.1.5. 604Fh Device Local

This object defines the supported control mode. The controller has only one possibility, therefore the content of this object is constant and equal to 0. This indicates that the device can only receive the setpoint via BUS.

11.4.1.6. 6380h VRPC Setpoint

The pressure setpoint is sent in subindex 01h of this object. The unit of measurement with which the data is transmitted depends on the objects 200Bh and 200Ch (denominator and numerator). The default unit is in mBar.

	Operation and maintenance instructions Series PME CANopen proportional pressure regulator	5000054187 Ver. 01
----------------------------------------------------------------------------------	----------------------------------------------------------------------------------------------------------------------	---------------------------

11.4.1.7. 6381h VRPC Actual Value

The current pressure value read by the regulator is written in subindex 01h of this object. The unit of measurement with which the data is transmitted depends on the objects 200Bh and 200Ch (denominator and numerator). The default unit is in mBar. This object could be mapped into a PDO, but if so and it is mapped on variations, the user must be careful to insert an inhibit time to avoid that the read pressure saturates the bus. This happens because the actual value of the pressure has a noise, this noise makes the PRE send a message at every cycle even if it is changed of few kPa.

11.5. Manufacturer Objects

ID	SUB	DESCRIPTION	TYPE	ACCESS	PDO MAPPING	DEFAULT VALUE
2001h	0	Pressure regulation check mode	U8	RW		0x0
2002h	0	Enable pressure regulation check	U8	RW		0x0
2003h	0	Pressure regulation check timeout	U8	RW		0x1
2004h	0	Pressure regulation protection timeout	U8	RW		0x1
2007h	0	Fail safe	U8	RW		0x0
2008h	0	PID Mode	U8	RW		0x0
2009h		PID Custom Parameter				
	0	Highest sub-index supported	U32	RW		0x6
	1	KP Up	U32	RW		0x0
	2	KI Up	U32	RW		0x0
	3	KD Up	U32	RW		0x0
	4	KP Down	U32	RW		0x0
	5	KI Down	U32	RW		0x0
	6	KD Down	U32	RW		0x0
200Bh	0	Numerator multiplier	U16	RW		0x1
200Ch	0	Denominator multiplier	U16	RW		0x0A
200Dh	0	Error code	U32	R	x	0x0
200Eh	0	Dead band	U16	RW		0x0
200Fh	0	Enable pressure switch control	U8	RW		0x0
2010h	0	Lower limit switch control	U16	RW		0x0
2011h	0	Upper limit switch control	U16	RW		0x3E8
2012h	0	Enable pressure window control	U8	RW		0x0
2013h	0	Lower limit window control	U16	RW		0x64
2014h	0	Upper limit window control	U16	RW		0x64
2015h	0	Use profile CiA 408	U8	RW		0x1
2016h	0	Enable Termination Resistance	U8	RW		0x0
2017h	0	Enable Emergency Transmission	U8	RW		0x1
2018h	0	Hysteresis	U16	RW		0x0
2019h	0	Internal sensor filter cutoff	U18	RW		0x0

	Operation and maintenance instructions Series PME CANopen proportional pressure regulator	5000054187
		Ver. 01

11.5.1. Manufacturer objects description

11.5.1.1. 2001h Pressure regulation check mode

Sets the type of event, warning or alarm, in case the regulated pressure doesn't reach the target value. See parameter "Pressure regulation check timeout". In the event of a warning, pressure regulation is not interrupted; on the other hand, in the event of an error, pressure regulation is interrupted.

11.5.1.2. 2002h Enable pressure regulation check

Enables to control the regulated pressure. This control is similar to the "window" function of the digital output (for more details regarding this function, refer to paragraph "Digital output"): the regulator checks if the regulated pressure reaches the pressure target within a certain settable time (Pressure regulation timeout). This control uses the values "Negative window level" and "Positive window level" to determine the tolerance range on the regulated pressure.

11.5.1.3. 2003h Pressure regulation check timeout

Serves to set the timeout value for the pressure regulation check. Refer to the "Enable pressure regulation check" parameter.

11.5.1.4. 2004h Pressure regulation protection timeout

Sets the inactivity time of the regulator when the target pressure is not reached before the expiration of the Pressure regulation timeout. During the period of inactivity, the regulator maintains the current pressure without trying to reach the target pressure. After this inactivity time has expired, the regulator will try again to reach the target pressure. Use this parameter if you want to avoid that the regulator keeps the internal valves activated for too long, reducing their expected lifetime. If the parameter is 0, the function is disabled.

11.5.1.5. 2007h Fail safe

This object sets the behaviour of the pressure regulator in the event that the cyclic data are no longer valid (can only be used in node guarding configuration).

Based on the value of this parameter, the pressure regulator can maintain the last valid target received (0 - Maintenance) or adjust a zero pressure (1 - Discharge).

11.5.1.6. 2008h PID mode

Serves to set the PID gains according to the air volume used. The available values are:

- 0: SET1 (SLOW, suitable for small volumes).
- 1: SET2 (MEDIUM, suitable for medium volumes).
- 2: SET3 (FAST, suitable for big volumes).
- 3: SET4 (CUSTOM).

	Operation and maintenance instructions Series PME CANopen proportional pressure regulator	5000054187
		Ver. 01

11.5.1.7. 2009h PID Custom Parameter

If PID CUSTOM is enabled (value 3 in object 2008h), then the control algorithm uses those parameters for controlling the pressure.

Those parameters are subdivided into UP and DOWN, which means that when the PRE should increment the pressure, the PID takes the values relative to the UP, DOWN otherwise. If the user is not confident with differencing the values, they might be set equal both for UP and DOWN.

ATTENTION: the system could be instable if you use values too high. Increase carefully the K parameters values. Do not create a system instability. The mechanical and electronic internal components could be damage. Avoid continuously oscillations of regulator (you hear a hammered noise). In this case decrease the K parameters values in order to eliminate the oscillations.

KP stands for “proportional gain”.

KI stands for “integral gain”.

KD stands for “derivative gain”.

11.5.1.8. 220Bh Numerator multiplier

This parameter, in combination with the 22C0h, allows you to change the unit of measurement for pressure used to read and write dictionary objects and PDOs. The default unit of measurement is mBar. This object divides all exchanged pressure-related parameters by its value. For example, to change the unit of measurement from mBar to kPa, it is necessary to set the numerator (object 220Bh) to 1 and the denominator (object 22C0h) to 1.

11.5.1.9. 220Ch Denominator multiplier

This parameter, in combination with the 22B0h, allows you to change the unit of measurement for pressure used to read and write dictionary objects and PDOs. The default unit of measurement is mBar. This object divides all exchanged pressure-related parameters by its value. For example, to change the unit of measurement from mBar to kPa, it is necessary to set the numerator (object 220Bh) to 1 and the denominator (object 22C0h) to 1.

11.5.1.10. 200Dh Error code

This object contains the error code. Each bit indicates a different error type:

- Bit 0, alarm internal error;
- Bit 1, alarm memory error;
- Bit 2, alarm pressure sensor;
- Bit 3, alarm solenoid fault;
- Bit 4, warning internal;
- Bit 5, warning memory;
- Bit 6, warning pressure;

- Bit 7, warning window control;
- Bit 8, warning switch control;
- Bit 9, warning no activation valve;
- Bit 10, warning valve diagnostic;
- Bit 11, warning under-voltage.
- Bit 12, warning target out of range

11.5.1.11. 200Eh Dead band

This parameter sets the dead band value for the regulated pressure. When this parameter is set to a value higher than 0, the regulator will not make any adjustment as long as the absolute error of the regulated pressure (difference between the regulated pressure and the target pressure) remains lower than the set dead band value (red line).

On the other hand, when the absolute error of the regulated pressure exceeds the value of the set dead band, the regulator returns to carry out normal regulation (green line).

This operating mode makes it possible to avoid continuous adjustments by the regulator, increasing its life cycle. On the other hand, the achievement of the target pressure according to the declared performance is not guaranteed: the adjusted pressure error will depend directly on the dead band value set.

The unit of measurement of the parameter depends on objects 200Bh and 200Ch; the default unit of measurement is the mBar.

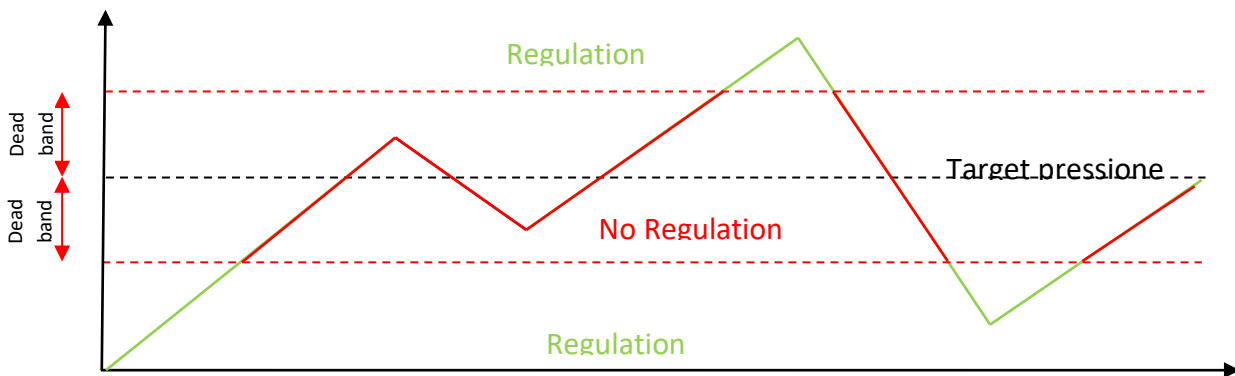

11.5.1.12. 200Fh Enable pressure switch control

This object enables the "Pressure Switch" control on the pressure reading, it can be 0 = Disable or 1 = Enable. With this operating mode it is possible to set two fixed pressure thresholds, lower one and an upper one: if the regulated pressure is outside the range delimited by the two thresholds set, the Controller will signal the event with a warning, but will not interrupt the regulation. In this case the diagnostic led will not change its status.

This is a useful way to verify that the regulated pressure is within a predetermined pressure range or not.

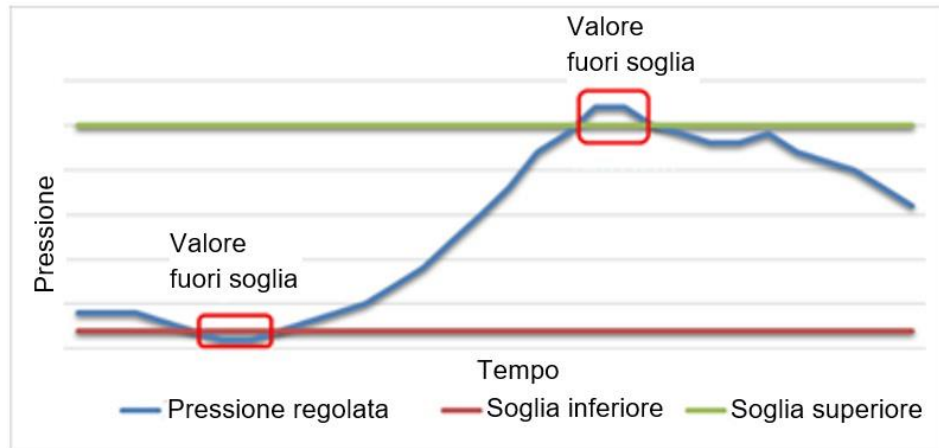

11.5.1.13. 2010h Lower limit switch control

This object sets the lower threshold for the pressure switch mode in the unit of measure of the Regulator, it must be a positive value and less than the "Upper limit switch control" parameter.

11.5.1.14. 2011h Upper limit switch control

This object sets the upper threshold for the pressure switch mode in the unit of measure of the Regulator, it must be a positive value and greater than the "Lower limit switch control" parameter.

11.5.1.15. 2012h Enable pressure window control

This object enables the "Pressure Window" control on the regulated pressure, it can be 0 = Disable or 1 = Enable. With this operating mode it is possible to set two thresholds, a lower one and a higher one, which determine a pressure range with respect to the target pressure value : if the regulated pressure is outside the instantaneous range (it depends on the target pressure value at that moment) delimited by the two set thresholds, the regulator will signal the event with a warning, but it will not interrupt the regulation and the diagnostics will not change its status.

This is a useful way to verify that the regulated pressure is within a predetermined accuracy range or not.

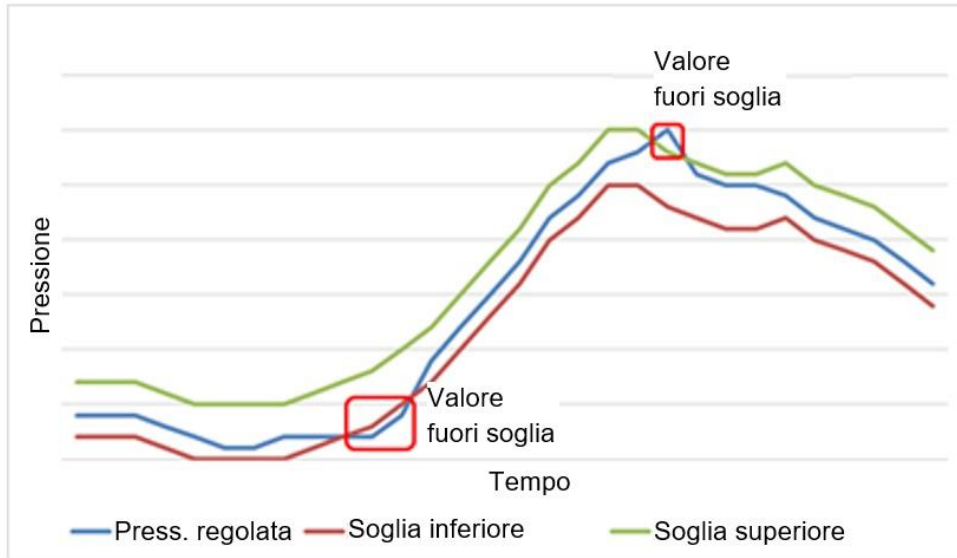

11.5.1.16. 2013h Lower limit window control

This object sets the lower differential for the pressure windows mode in the unit of measure of the Regulator, it must be a positive value and less than the "Upper limit windows control" parameter.

11.5.1.17. 2014h Upper limit window control

This object sets the higher differential for the pressure windows mode in the unit of measure of the Regulator, it must be a positive value and greater than the "Lower limit windows control" parameter

11.5.1.18. 2015h Use profile CiA 408

This object allows you to enable / disable the CiA 408 profile. If enabled, the operating status will follow the state machine specified in the profile with the use of objects 6040h Control Word and 6041h Status Word.

11.5.1.19. 2016h Enable Termination Resistance

This object allows you to enable / disable the termination resistor inside the device. This object must be enabled if the regulator is the last node of the CANopen line. This enables a 120 ohm resistor in parallel to the CAN lines, as shown below.

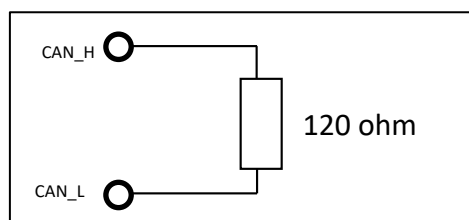

11.5.1.20. 2017h Enable Emergency Transmission

This object allows you to enable / disable the transmission of the emergency messages described in the CiA 301 profile. If the transmission is disabled, no acyclic diagnostic message will be generated, the errors will only be visible from the system LED and by reading the specific objects.

11.5.1.21. 2018h Hysteresis

This object is available only if the dead band value is greater than 0. When the absolute error of the adjusted pressure (difference between the adjusted pressure and the target pressure) remains below the dead band value set for a sufficient time, the regulated pressure is considered stable and the hysteresis operating mode (A) is activated. If, on the other hand, the absolute error of the regulated pressure remains lower than the dead band value set for a NOT sufficient time, the regulated pressure is deemed NOT stable and the hysteresis operating mode (B) is NOT activated.

When the hysteresis operating mode is active, the regulator will not make any adjustment as long as the absolute error of the regulated pressure remains less than the value of the sum of the dead band and hysteresis values set (C).

When the absolute error of the regulated pressure exceeds the value of the sum of the dead band and hysteresis values set, the hysteresis operating mode is deactivated (D) and therefore the regulator will not carry out any regulation only if the absolute error of the regulated pressure becomes lower than the set dead band value (E). To reactivate the hysteresis operating mode, the absolute error of the regulated pressure must remain below the dead band value set for a sufficient time.

This operating mode allows to reach the target pressure with sufficient precision, according to the dead band value set, and to define a wider range, defined by the set hysteresis value, in which the regulator will not perform any regulation.

Compatibly with the application carried out by the regulator, it is recommended to set:

- the dead band value as small as possible, in order to obtain a good regulation precision of the regulated pressure
- the hysteresis value as large as possible, generally greater than the dead band value, in order to limit the number of actuations of the regulator.

The unit of measurement of the parameter depends on objects 200Bh and 200Ch; the default unit of measurement is the mBar.

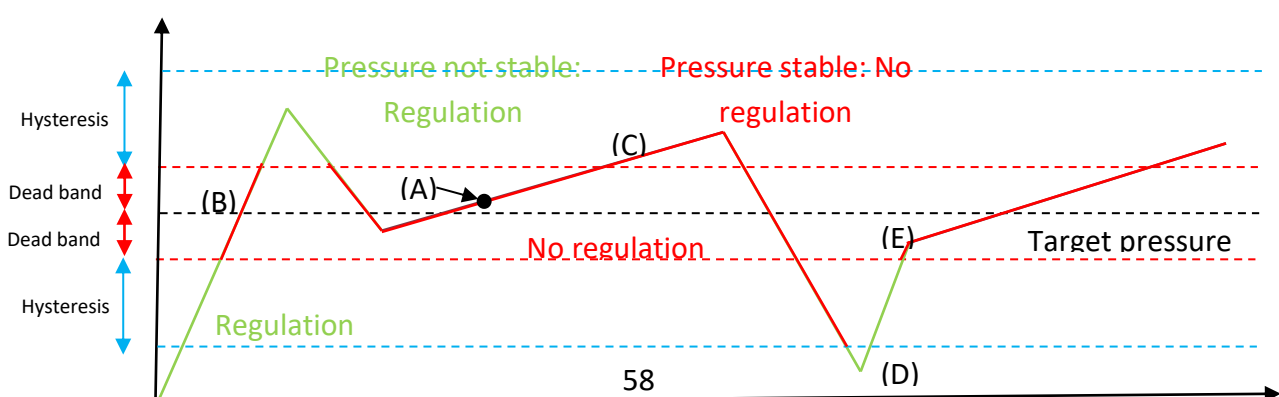

	Operation and maintenance instructions Series PME CANopen proportional pressure regulator	5000054187 Ver. 01
----------------------------------------------------------------------------------	----------------------------------------------------------------------------------------------------------------------	---------------------------

11.5.1.22. 2019h Internal sensor filter cutoff

This parameter sets the cutoff frequency [Hz] of the digital filter applied to the internal sensor signal. Use this parameter to eliminate noise in the regulated pressure signal. A big value of this parameters increases the time response of the regulator. If the value of this parameter is 0, the filter is disabled.

12.Diagnostic





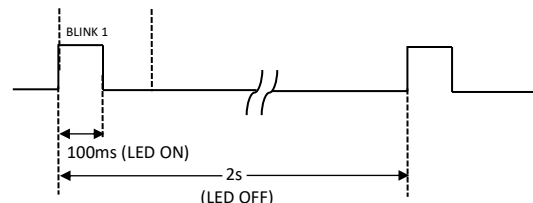
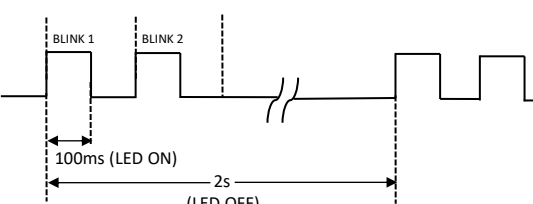

PME CANopen module diagnostics are available in two different ways

- By the software messages are sent via CANopen line
- By the status led on the regulator. The following table shows the legend of the typical operation of the LED.

SYMBOL	LED STATUS	DESCRIPTION
◐	LED OFF	LED is OFF.
◯	LED ON	LED is fixed ON.
	BLINKING	<p>LED is blinking according to a specific sequence associated to the different diagnostic state: @XX [ms/Hz] per YY [s]</p> <ul style="list-style-type: none"> ▪ XX is the ON/OFF time duration of a blink. ▪ YY is the repetition time of blinking sequence. <p>Example 1: 1 blink @100 ms every 2 s</p>  <p>Example 2: 2 blinks @100 ms every 2 s</p> 

13. Use

- Ensure that the pressure in the compressed air supply system and all other operating conditions remain within the admissible values.
- Use with liquids or gas is not permitted according to the intended use
- The LED bar on the regulator provides information regarding the status of the product, please refer to the table below.

DEVICE STATUS	LED STATUS	MEANING
Normal operation.	 GREEN ON	Regulator is working with no errors or warnings.
The regulator has registered an ERROR . Pressure regulation is interrupted.	 1 RED blink @200 ms every 3 s	ALARM_INTERNAL: an internal component of regulator doesn't work properly.
	 2 RED blinks @200 ms every 3 s	ALARM_PRESSURE: the regulator is not able to reach the target pressure.
The regulator has registered a WARNING . Pressure regulation is not interrupted.	 1 YELLOW/ORANGE blink @200 ms every 3 s	WARNING_INTERNAL: an internal component of regulator doesn't work properly
	 2 YELLOW/ORANGE blinks @200 ms every 3 s	WARNING_PRESSURE: the regulator is not able to reach the target pressure.
	 3 YELLOW/ORANGE blinks @200 ms every 3 s	WARNING_CANOPEN_SIGNAL: the target is out of range.
	 4 YELLOW/ORANGE blinks @200 ms every 3 s	WARNING_UNDERVOLTAGE: power supply is below the minimum value

Note: during startup operation, the led is red fixed.

	Operation and maintenance instructions Series PME CANopen proportional pressure regulator	5000054187 Ver. 01
----------------------------------------------------------------------------------	----------------------------------------------------------------------------------------------------------------------	---------------------------

14. Limitations on use

- Never exceed the technical specifications stated in the paragraph "General characteristics" and the Camozzi general catalogue.
- With the exception of specific intended applications, do not use the product in environments where there is the risk of direct contact with corrosive gas, chemical products, salt water, water or steam.
- If possible, do not install the device:
 - in closed and small spaces
 - exposed to direct sunlight (if necessary, provide a shield)
 - near heat sources or in areas subject to sudden changes in temperature
 - near power on parts with no proper insulation
 - near conductors or electrical devices with high alternate or impulsive currents (danger of parasitic currents);
 - near sources of high intensity electromagnetic waves (antennas) (danger of parasitic currents and / or arcing of electric arcs).

15. Maintenance

- Check all conditions to prevent the inadvertent release of parts and disconnect the power supply to enable the discharge of residual pressure from the system before performing work.
- Discharge all pressure from the system and the actuator itself.
- Check whether it is possible to have the product serviced at a technical assistance centre.
- Never disassemble units when pressurized.
- Shut off all pneumatic, hydraulic and electric supplies before maintenance.

16. Environmental notes

- At the end of the product's life cycle, separate the relative materials to enable recycling.
- Observe all current standards in the country of use governing waste disposal.
- The product and relative parts all comply with the standards ROHS and REACH.

Parti	Materiali
1 = corpo	Alluminio Anodizzato
2 = corpo valvola	PARA GF50%
3 = copertura	PA6 CM 30%
4 = viti	Acciaio Inox
5 = molle	Acciaio Inox
6 = tappo	Ottone Nichelato
7 = guarnizioni e OR	NBR
8 = perni per visione manifold	Acciaio Inox solo per versione manifold
9 = membrana	NBR
10 = fondello	Alluminio Anodizzato
11 = stelo pistone	Acciaio Inox
12 = guarnizione pistone	NB

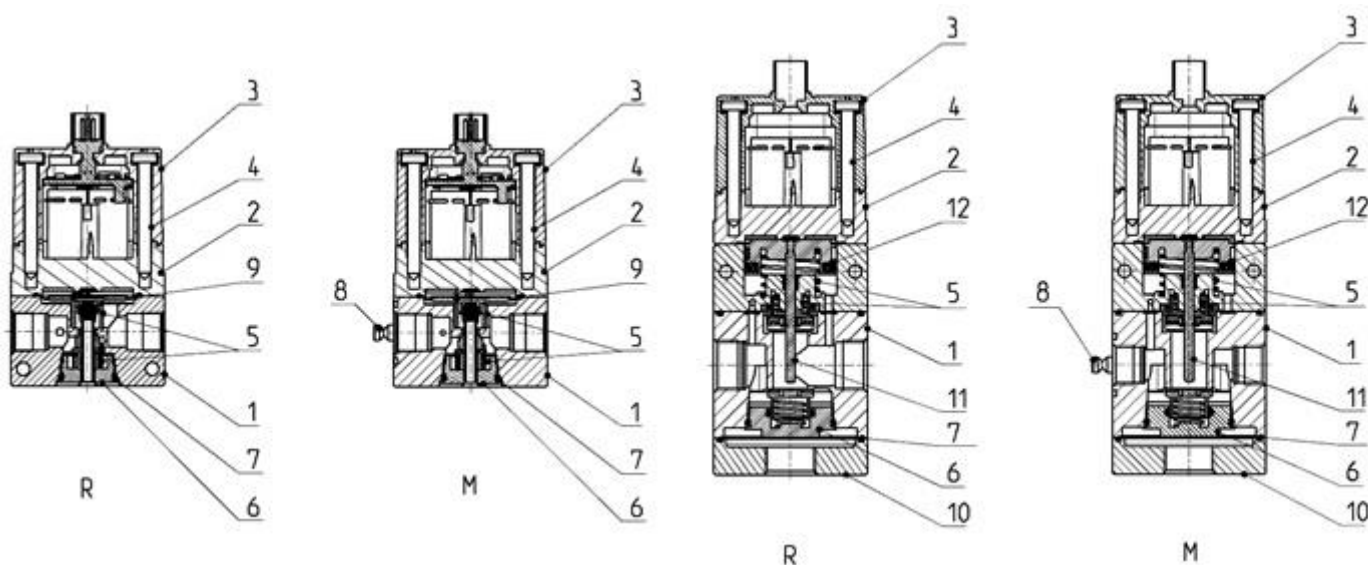

 CAMOZZI Automation	Operation and maintenance instructions Series PME CANopen proportional pressure regulator	5000054187
		Ver. 01

17. Contacts

Camozzi Automation S.p.A.

Società Unipersonale

Via Eritrea, 20/I

25126 Brescia - Italy

Tel. +39 030 37921

info@camozzi.com

www.camozzi.com

Product certification

product certifications

CE marking

declarations of conformity and instructions

productcertification@camozzi.com

Technical assistance

Technical information

Product information

Special products

Tel.+39 030 3792790

service@camozzi.com