

# Series DRCS drive for Stepper motors



# Contents

1. Product identification	3
2. General recommendations	3
3. General characteristics and conditions of use	4
4. Electrical circuit	4
5. Product transport and storage	4
6. System general description	5
7. Installation and start-up	5
7.1 DRCS power supply	6
7.2 DRCS encoder	6
7.3 Proximity connector	7
7.4 Motor connector	7
7.5 Brake connector	8
7.6 CANopen connector	8
7.7 25-pin SUB-D connector	8
7.8 Inputs	8
7.9 Outputs	9
7.10 Steps to realise a movement	10
7.11 PC requirements	10
8. Operation	11
9. Troubleshooting and/or exceptional circumstances	11
10. Limitations on use	11
11. Maintenance	11
12. Environmental notes	11



The products are designed and manufactured in conformity with the following directives: 2014/30/UE  
They also comply partially or totally regarding the applicable parts of the following standards: CEI EN 61131-2

## 1. Product identification

Conversion table for the production date

Position 1 and 2: n° of the week			
01	14	27	40
02	15	28	41
03	16	29	42
04	17	30	43
05	18	31	44
06	19	32	45
07	20	33	46
08	21	34	47
09	22	35	48
10	23	36	49
11	24	37	50
12	25	38	51
13	26	39	52

Position 3: one letter for the present year				
A		1996	2021	2046
B		1997	2022	2047
C		1998	2023	2048
D		1999	2024	2049
E		2000	2025	2050
F		2001	2026	2051
G		2002	2027	2052
H		2003	2028	2053
I		2004	2029	2054
K		2005	2030	2055
L		2006	2031	2056
M		2007	2032	2057
N		2008	2033	2058
O		2009	2034	2059
P		2010	2035	2060
Q		2011	2036	2061
R		2012	2037	2062
S	1988	2013	2038	2063
T	1989	2014	2039	2064
U	1990	2015	2040	2065
V	1991	2016	2041	2066
W	1992	2017	2042	2067
X	1993	2018	2043	2068
Y	1994	2019	2044	2069
Z	1995	2020	2045	2070

Example of composition	
<b>03P</b>	
Description:	
<b>03</b>	Week n° 03
<b>P</b>	Year 2010

## 2. General recommendations

The recommendations regarding safe use, described in this document, should be observed at all times.

- Some hazards can only be associated with the product after it has been installed on the machine/equipment. It is the responsibility of the end user to identify these hazards and reduce the associated risks accordingly.
- The product described in this manual may be used in circuits that must comply with the standard EN ISO 13849-1.
- For information regarding component reliability, contact Camozzi.
- Before proceeding to use this product carefully read all information in this document.
- Keep this document in a safe place where it is accessible to all personnel throughout the product life cycle.
- This document should accompany the product in the event of transfer to a new owner or user.
- The instructions in this manual must be observed together with the instructions and additional information available from the following references:
  - website <http://www.camozzi.com>
  - Camozzi general catalogue
  - Technical assistance service
- Based on these instructions, only qualified and authorised personnel must perform assembly and start-up operations.
- It is the responsibility of the system/machine designer to ensure the correct selection of the most suitable pneumatic component according to the intended application.
- It is recommended to use suitable protection to minimise the risk of physical injury.
- For all situations not covered in this manual and in situations in which there is a potential risk of damage or injury to objects, persons or animals, contact Camozzi for advice.
- Never make unauthorised modifications to the product. In this case, any damage or injury to objects, persons or animals will be the responsibility of the user.
- All relevant product safety standards must be observed at all times.
- Never interfere with the machine/system before verifying that all working conditions are safe.
- Before installation and maintenance, ensure that the envisaged safety locks are active. In particular, disconnect the electrical mains (if necessary) and system pressure supply, thereby discharging all residual compressed air from the circuit and deactivating residual energy stored in springs, condensers, recipients and gravity.
- After installation or maintenance, the system pressure and electrical power supply (if necessary) must be connected, after which the operator must check correct operation and sealing efficiency of the product. In the event of sealing failure or malfunction, the product must not be used.
- The product may only be used with adherence to the specifications provided; if these requirements are not met, the product may only be used with authorization from Camozzi.
- Avoid covering the equipment with paint or other substances that may reduce heat dissipation.

### 3. General characteristics and conditions of use

Assembly position	Any
Overall dimensions	L = 122,6 mm; W = 113,2 mm; H = 39 mm
Weight	460 g (approx.)
Ambient temperature	0 - 40°C (up to 55°C with forced ventilation)
Storage temperature	-20°C ÷ 70°C
Ambient humidity	Max 90%
IP protection rating according to EN 60529	IP20
Vibrations	1G (10 to 500 Hz)
Altitude	< 1000 meters
Electrical logic supply	18 - 32 V DC
Electrical power supply	24 - 60 V DC
Current	0,1 - 5 A (limited by fuse)
Holding current	Automatic reduction of the holding current with motor stopped, set in the "holding current" function as a current or time value
Protection	Overvoltage, undervoltage, over temperature, short circuit and earth fault
Method of control	4 PWM states 20kHz
Type of amplification	Dual H-Bridge, 4 Quadrants
Control position Encoder	100 to 5000 differential pulses / revolution
Control signal Input	12 opto-isolated 24 V DC
Control signal Output	6 opto-isolated
Frequency Input	Step and direction input, max frequency 60kHz, 5V
Brake control signal Output	Electromechanical brake, max current 1 A
USB	USB 2.0
Bluetooth	BL 2.1 + EDR and BLE 4.0 standard (only for models DRCS-XXX-X-X-X-B)
RFID	With NFC device
CANopen	CANopen standard (CiA 402 and 301 profiles)
Microstep emulation	High resolution via micro-stepping and accurate synchronisation Reduction of oscillations and vibrations due to resonance
Anti-resonance	Activation of the oscillation system in order to reduce the vibrations to obtain smooth motion and speed control, by dampening the oscillation time
Signalling	Green Led
Configuration	Digital, using Camozzi's configuration software QSet
Control methods	Digital Inputs, Frequency, CANopen (only for models DRCS-XXX-X-C-X-X)
Data retention memory	Flash
Data backup memory	E <sup>2</sup> prom

### 4. Electrical circuit

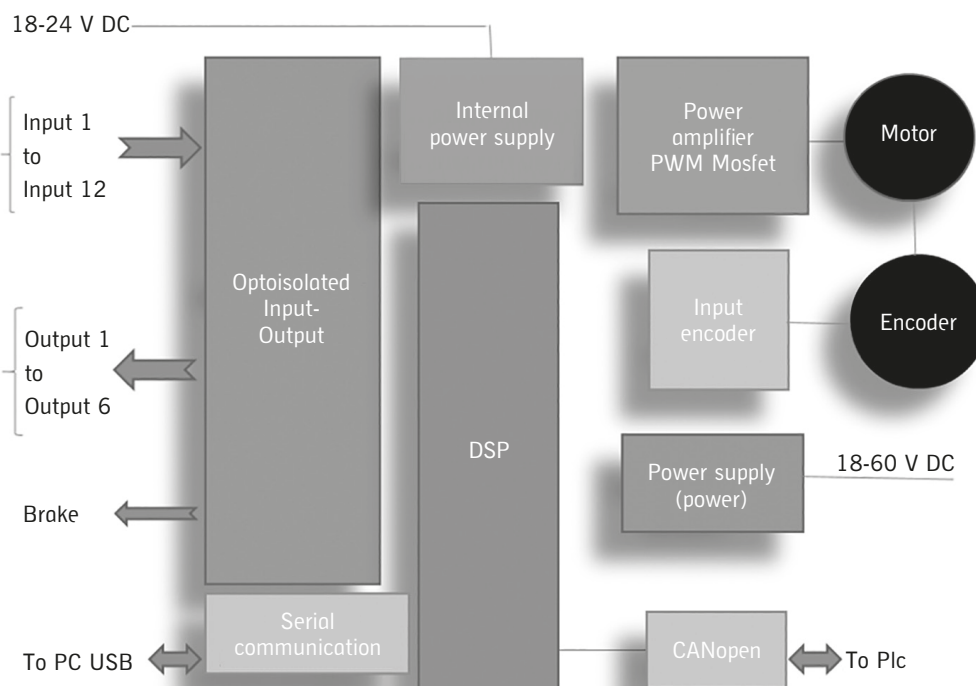

### 5. Product transport and storage

- Take all possible measures to avoid accidental damage to the product during transport, and use the original packaging if available.
- Observe the specified storage temperature.

## 6. System general description

The Camozzi DRCS drive has been developed to optimise the performance of Camozzi Stepper motors. By using the micro-stepping technology (resolution up to 1/16 of step) it is possible to obtain a near-perfect sinusoidal current, thus significantly reducing the natural resonance of the motor.

Many different control methods are available:

- Digital control: the availability of 7 inputs allows the realisation of a command table of 128 lines and for each command line it is possible to set the position, the speed, the acceleration and deceleration. Each command can be either absolute or relative.
- Frequency control: it is possible to configure the drive frequency control using commands Step and Direction. The step rate defines the speed and the number of steps defines the position.
- CANopen control (only for models DRCS-XXX-X-C-X-X): it is possible to control the DRCS drive via CANopen (profile standards CiA301 and CiA402)

The DRCS drive can be configured via USB or wirelessly using the Bluetooth protocol (only for models DRCS-XXX-X-X-X-B). The DRCS drive is configurable through Camozzi's software QSet (for more details on using this configurator and its features, refer to the specific manual).

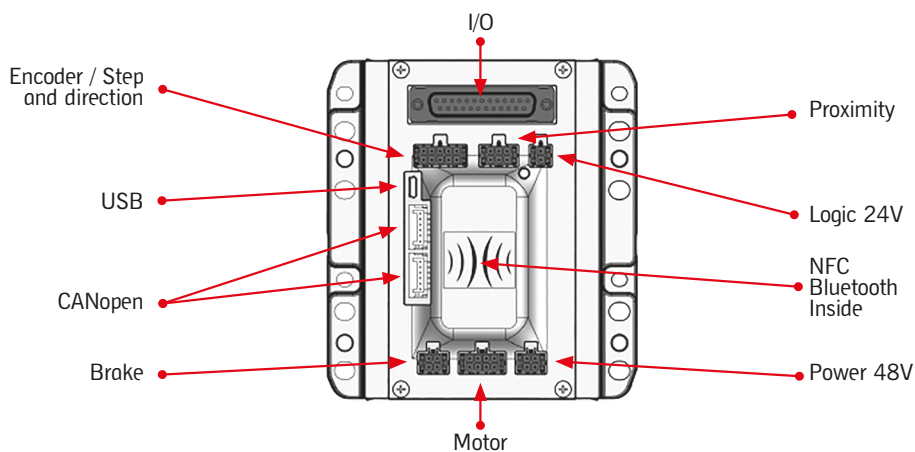

## 7. Installation and start-up

- During unpacking, take great care not to damage the product.
- Check if there are any faults from transportation or storage of the product.
- Separate all packaging material to allow for the recovery or disposal in accordance with current regulations in the country of use.
- Before using the component, ensure that the stated specifications and performance features correspond to what is required.
- During installation, ensure that suitable surge protection devices are used.
- During installation, verify that no hazards due to mechanical movements are introduced.
- Install the component in an area where the set-up and maintenance operations are easily performed without creating a hazard for the operator.
- Isolate any unused connection wires with suitable safety caps or covers.
- The components must be fixed properly, where possible, using appropriate fasteners and ensuring that the fixture remains effective even when the actuator operates at a high frequency or in the presence of strong vibrations.
- In the event of strong vibrations, provide suitable devices or systems that can dampen the effect these vibrations have on the drive.
- Provide for the installation of dehumidifiers in order to prevent moisture or condensation in the internal components.
- If the device is used to operate an actuator of which any accidental movement can create a hazard, provide suitable locking devices on the mobile section of the actuator.
- Ensure that the connectors are connected and secured properly.
- The device can be fastened on a DIN rail with the appropriate accessory, PCF-E520, mounted on the rear of the body.
- The component can be fixed directly to a support using the 8 holes (2 of which have an M6 thread) present on the both sides of the body.

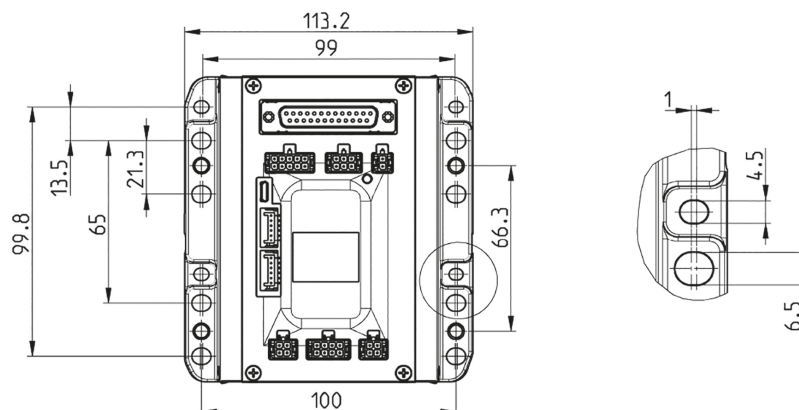

### 7.1 DRCS Power Supply

When choosing the power supply, adhere to all regulatory and safety requirements of the DRCS drive, presented in this manual.

It is important to choose the correct voltage and current.

It is important to use power supplies equipped with “soft start” to avoid inrush currents that could damage the DRCS drive.

• Voltage

The supply voltage must be regulated and stabilised so as to avoid losses in speed and torque.

For Stepper motors, the voltage is directly proportional to motor speed.

• Current

The required current should be the sum of the two phase currents, but the DRCS drive controls the current with frequency modulation, so it requires less current. In particular, the current required when operating at 24V will be double than that required when operating at 48V.

In order to size the power supply correctly, we recommend using a power supply with double the expected current capacity and analyse the operation at full load with a current probe. This will indicate the maximum current rating required for successful operation.

• The information that follows shows the pinouts and details of the various connector ports located on the front of the DRCS module:

LOGIC 24V 2-POLE FEMALE CONNECTOR (LOGIC)		
Pin	Signal	Description
1	L24V	24V DC power supply (logic): connect to the positive pole of the 24V DC power supply (ref. GND)
2	GND	Common (reference pin 1): connect to the negative pole of the 24V DC power supply (compulsory).



Inside the DRCS drive, there is a non-resettable fuse that protects the logic circuit. If a replaceable fuse is necessary, connect a 3A fast-blow fuse externally, in-line with the power cable. The logic power is applied to the LOGIC 24V connector; use copper wires with an AWG22 cross section.

**Warning: reversing the positive and negative poles can damage the DRCS drive.**

POWER 48V 4-POLE FEMALE CONNECTOR (POWER)		
Pin	Signal	Description
1	P48V	48V DC power supply (power): connect to the positive pole of the 48V DC power supply (ref. GND)
2		
3	GND	Common (ref. for pin 1 and 2): connect to the negative pole of the 48V DC power supply (compulsory)
4		



Inside the DRCS drive, there is a non-resettable fuse that protects the logic circuit. If a replaceable fuse is necessary, connect an 8A ultra fast (FF) blow fuse externally, in-line with the power cable.

The motor power is applied to the POWER 48V connector; use copper wires with an AWG18 cross section.

**Warning: reversing the positive and negative poles can damage the DRCS drive.**

### 7.2 DRCS Encoder

Pin	Signal	Mode Description	Mode Description
		DIGITAL INPUT or CANopen	STEP-DIRECTION
1	+5V	+5V power supply for external encoder (ref. GND)	
2	FASE B-	Encoder phase B negative pole	Direction input negative pole
3	FASE Z-	Encoder phase Z negative pole	Not used
4	FASE B+	Encoder phase B positive pole	Direction input positive pole
5	FASE Z+	Encoder phase Z positive pole	Not used
6	FASE A-	Encoder phase A negative pole	Step input negative pole
7	GND	Common (ref. for pin 1)	
8	FASE A+	Encoder phase A positive pole	Step input positive pole
9	GND	Common (ref. for pin 1)	
10	SHIELD	Encoder cable shield	Not used

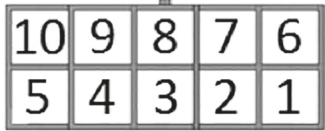

A differential connection for the encoder powered with +5V is available and a single-ended connection connects the signals A+, B+ and Z+ to the +5V. The following picture shows the internal connection on DRCS drive.

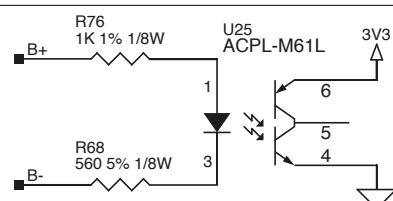
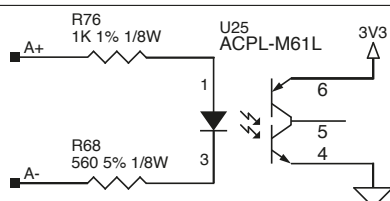
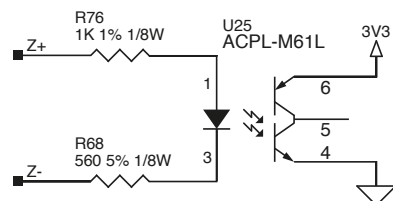
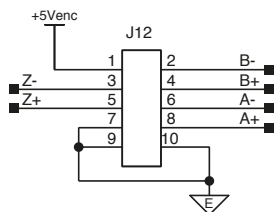

### 7.3 Proximity connector

Pin	Signal	Description
1	+24V	+24V power for external proximity (ref. GND)
2	HMG	Input for Homing sensor
3	GND	Common (ref. for pin 1)
4	EXCOM1	Excom1 common (PNP=GND and NPN=+24V DC)
5	GND	Common (ref. for pin 1)
6	OPT	Input for Proximity / external stop (optional)



It is possible to connect two proximity switches, one for Homing functionality and another for various functions:

1. Extra stroke sensor
  2. Stop movement command (use it for stop the movement before to reach the target position)
- Is possible to use both NPN and PNP proximity switches.

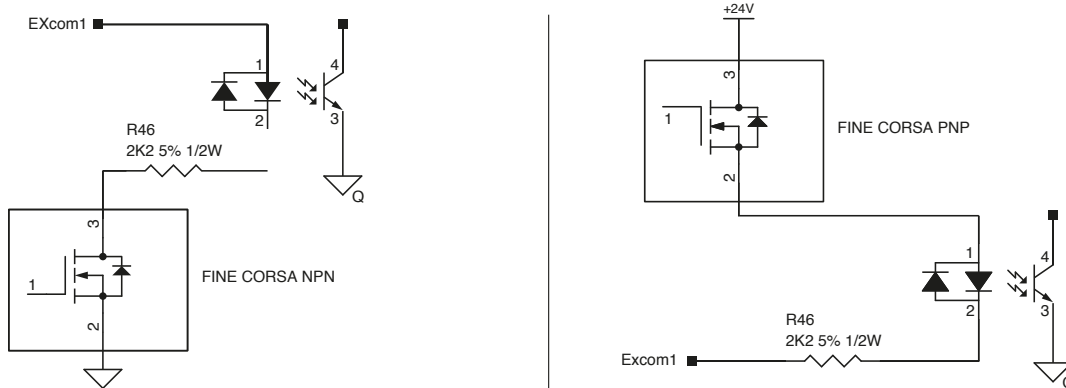

### 7.4 Motor connector

Pin	Signal	Description
1	B-	Motor phase B negative pole
2	B-	Motor phase B negative pole
3	A-	Motor phase A negative pole
4	A-	Motor phase A negative pole
5	B+	Motor phase B positive pole
6	B+	Motor phase B positive pole
7	A+	Motor phase A positive pole
8	A+	Motor phase A positive pole

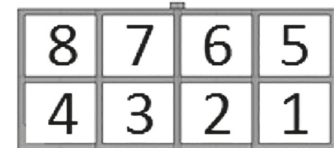

Stepper motors can have 4- or 8- wire configurations; the following pictures show these configurations and the connections for the most common types of Stepper motors. The motor must be connected to the MOTOR connector:

#### 4-wire motor:

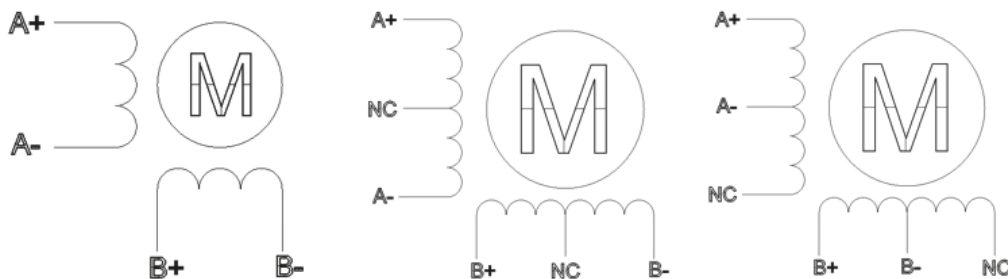

#### 8-wire motor:

As shown in the following picture, the 8-wire motors permit two different connection schemes: series or parallel. In the series connection scheme, the high-speed torque is lower, but the losses and operating temperature are also reduced. With this scheme, it is recommended to decrease the phase current by at least 30%. In the parallel connection scheme, the torque and speed of the motor follow the torque-speed characteristic curve.

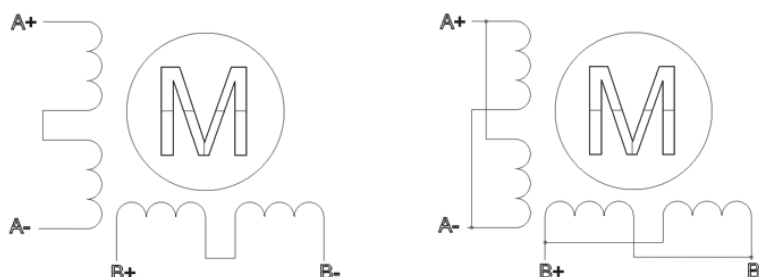

### 7.5 Brake connector

Pin	Signal	Description	
1	+24V	+24V power supply (ref. <b>GND_B</b> )	
2			
3	<b>GND_B</b>	Common (ref. for pin 1)	
4			

The DRCS drive allows for the connection of a DC electromechanical brake; the control current must exceed 0.6A.

The brake is controlled automatically by synchronising with the enable signal:

- If the enable signal (**ENB**) is enabled, the brake is open (brake powered)
- If the enable signal (**ENB**) is disabled, the brake is closed (brake not powered)

### 7.6 CANopen connector

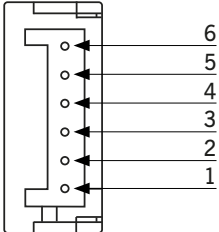
Pin	Signal	Description	
1	<b>GND</b>	Common (ref. for pins 5 and 6)	
2			
3	<b>CANL</b>	CAN-L bus	
4	<b>CANH</b>	CAN-H bus	
5	<b>24V_C</b>	Positive power supply for the bus (24V DC) - Optional	
6			

### 7.7 25-pin SUB-D connector

Pin	Signal	Description
1	<b>EXCOM1</b>	Proximity and Homing sensors common (ref. for pins 2 and 3)
2	<b>OPT</b>	Input for proximity/stop sensor (optional): refer to PROXIMITY connector
3	<b>HMG</b>	Input for Homing sensor: refer to PROXIMITY connector
4	<b>ENB</b>	Enable Input
5	<b>STB</b>	Strobe Input
6	<b>IN7</b>	Input 7 / Jog- input
7	<b>IN6</b>	Input 6 / Jog+ input
8	<b>IN5</b>	Input 5
9	<b>IN4</b>	Input 4
10	<b>IN3</b>	Input 3
11	<b>IN2</b>	Input 2
12	<b>IN1</b>	Input 1
13	<b>INO</b>	Input 0
14	<b>EXCOM</b>	Common (ref. for pins 4 to 13)
15	<b>+24V</b>	+24V power supply (ref. <b>GND</b> )
16	<b>GND</b>	Common (ref. for pin 15)
17		
18	<b>RDY</b>	Ready positive collector Output (QSet = OUTPUT6)
19	<b>HOK</b>	Homing OK positive collector Output (QSet = OUTPUT5)
20	<b>POS</b>	In Position positive collector Output (QSet = OUTPUT4)
21	<b>OUT+</b>	Configurable positive collector Output (QSet = OUTPUT3)
22	<b>OUT-</b>	Configurable negative emitter Output (QSet = OUTPUT3)
23	<b>ALM</b>	Alarm positive collector Output (QSet = OUTPUT1)
24	<b>BSY</b>	Busy positive collector Output (QSet = OUTPUT2)
25	<b>GND_O</b>	Output common (ref. for pins 18, 19, 20, 23 and 24)

### 7.8 Inputs

- Proximity (PIN 2): an extra stroke/stop input that, if set, causes the motor to stop using the ramp deceleration setted by the actual movement.
- Homing input (PIN 3): defines the zero position; the method used to conduct the Homing procedure is configurable with Camozzi's QSet software (for more details on using the configurator, specifically this feature, refer to the manual).

In order to activate the Homing procedure, it is necessary to follow these steps:

- Deactivate all inputs, from IN0 to IN7
- Activate the Enable input
- Activate the Strobe input: the procedure starts with the rising edge.

### Digital Inputs IN0-IN6

The digital inputs' common pin (**EXCOM**) can be connected to either the negative or positive pole of the power supply. Every program line set in **QSet** (for more details on using the configurator, specifically this feature, refer to the manual) corresponds to the binary combination of digital inputs as shown on the following page:



Strobe	IN7	IN6	IN5	IN4	IN3	IN2	IN1	INO	Line number
↑	0	0	0	0	0	0	0	0	Homing
↑	0	0	0	0	0	0	0	1	Line 1
↑	0	0	0	0	0	0	1	0	Line 2
↑	0	0	0	0	0	0	1	1	Line 3
↑	0	0	0	0	0	1	0	0	Line 4
↑	0	0	0	0	0	1	0	1	Line 5
↑	0	0	0	0	0	1	1	0	Line 6
↑	0	0	0	0	0	1	1	1	Line 7
									Line n
									Line n+1
↑	1	1	1	1	1	1	1	1	Line 127

The maximum number of selectable individual lines is 127 (Line 0 is reserved for Homing).

It is possible to connect either PNP or NPN devices to the inputs.

If the PNP type is desired, connect the **EXCOM** signal (pin 14 on I/O connector) to the negative pole of the power supply (GND); otherwise, if NPN type is desired, connect **EXCOM** (pin 14 on I/O connector) to the positive pole of the power supply (+24V).

The following picture show examples of each type of connection:

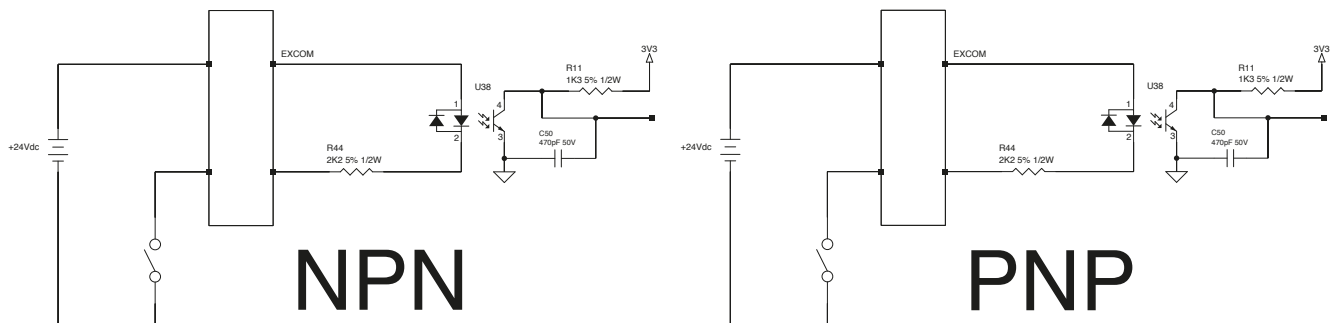

### IN7 and IN6

Via the QSet software is possible to set some external Jog commands to the driver; by using IN7 and IN6 inputs (respectively pin 6 and pin 7 on IO connector) is possible to command with pulse. Using IN7 and IN6 inputs as Jog command, the number of row in the table showed above will be reduced from 127 rows to 63 command rows.

### 7.9 Outputs

The DRCS drive provides 5 open collector outputs (NPN type) with a common pin (**GND\_O**) when is necessary to connect this pin to the negative poles of the power supply and a differential output. The maximum current for Alarm and Busy output is 50ma with maximum voltage 80 V DC, for the others outputs the limits are 150mA and 300V.

If the load is inductive (eg. a relay), it is necessary to connect a flyback diode.

If the load is an input module (eg. a PLC), connect a reverse-polarity protection device, if not already provided by the input module.

If the load could require a current greater than the maximum, connect a resistor in order to limit the current.

When an output is activated, its level is low, for exempla the Alarm output level is high without error, but the level became low when an error is present: in this way is easy to identify an error on cabling or a cable break.

The following picture show some examples of connection:

- Inductive load

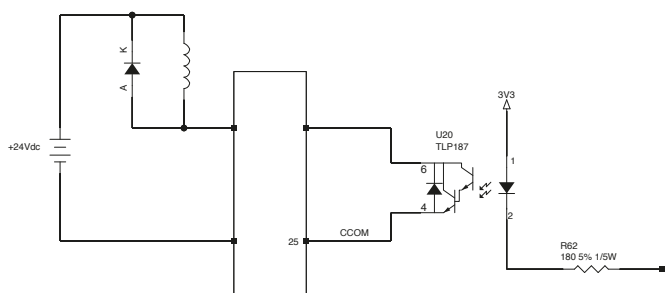

- Input module

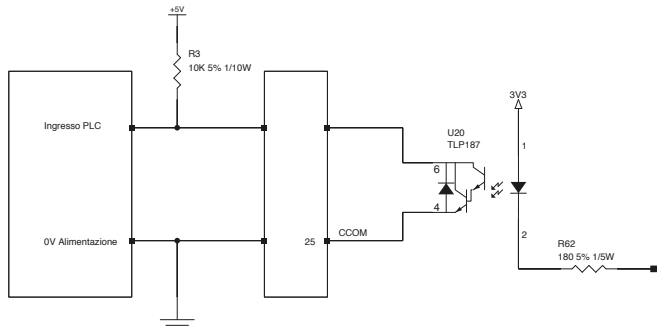

**The available outputs are:**

- Ready (**RDY**): indica che l'azionamento DRCS è abilitato senza allarmi, ed è pronto a ricevere un comando di moto.
- Homing OK (**HOK**): indica che la procedura di Homing (ricerca della posizione dio zero) è stata completata correttamente.
- Motore in posizione (**POS**): indica che il movimento è stato eseguito correttamente e la posizione è stata raggiunta.
- Busy (**BSY**): indica che il motore si sta muovendo e non può ricevere un ulteriore comando.
- Allarme (**ALM**): indica uno stato di allarme; nella tabella di allarme sono riportate tutte le possibili cause di guasto.
- Configurable output (**OUT+ and OUT-**): it is possible to set this output via the **QSet** software (for more details on using the configurator, specifically this feature, refer to the manual) as either PNP or NPN type, as shown below.

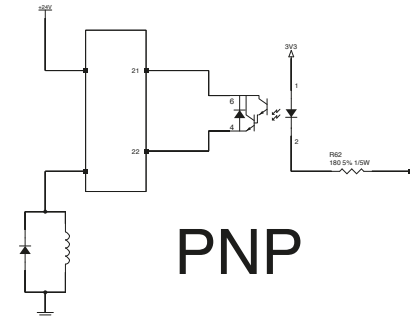
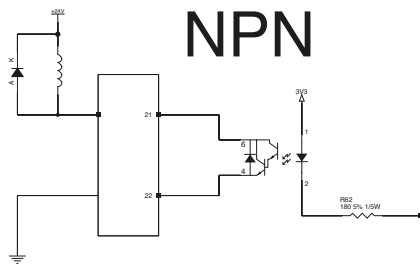
**7.10 Steps to realise a movement**

- In **QSet**, configure one or more command lines and load them to the DRCS drive using the “PC to Drive” command.  
Example: position 100 mm, velocity 500 mm/s, acceleration and deceleration 100 mm/s<sup>2</sup> entered into row 1:

PROG.	TYP COMMAND	FORCE [N] max 54	POSITION [mm] max 1500	VELOCITY [mm/s] max 3333	ACC [mm/s <sup>2</sup> ] max 5000	DEC [mm/s <sup>2</sup> ] max 5000
1	pos. Absolute	0.000	100.000	500.000	100.000	100.000

- Enable the DRCS drive by setting the Enable input (**ENB**).
- Deactivate all digital inputs (from **INO** to **IN6**) and verify, by observing the Ready output (**RDY**), that the DRCS drive is ready. If yes, generate a pulse (minimum width of 2ms) on the Strobe input (**STB**); the Homing procedure then starts and the Busy output (**BSY**) becomes active until the motion has ended.
- When the Homing procedure ends (refer to the Homing OK output (**HOK**), change the IN0 state to 1 and hold the inputs **IN1 ÷ IN6** at 0.
- Verify the Ready output (**RDY**) value and, if the DRCS drive is ready, generate a pulse (minimum width of 2ms) on the strobe input (**STB**).
- When the movement starts, the In Position output (**POS**) is deactivated and the Busy output (**BSY**) is activated until the motion ends.
- When the motion ends, the In Position output (**POS**) becomes active, the Busy output (**BSY**) is deactivated.

- The user must adopt the necessary measures to prevent damage to the system caused by voltage spikes on the power lines as a result of power outages of high-energy equipment.
- The DRCS board does have protection against reverse polarity of the power supply voltage.
- To improve noise immunity and prevent damage, it is recommended to connect the device to the system ground using any of the holes in the aluminium body, and attaching the conductor to the metal plate.
- Only for models DRCS-XXX-X-C-X-X, it is possible to set the node address, its baud rate (up to 1 M/s) and enable the CANopen communication mode (disabled by default) via the **QSet** configuration software (for more details on using the configurator, specifically this feature, refer to the manual).  
If the DRCS drive is the last node of the CANopen segment, it is necessary to use the termination resistor for the bus: the order code EC-060623 is for a DRCS drive that has this resistor installed, which can be mounted on one of the two CANopen connectors.
- To configure the DRCS drive, download the **QSet** software setup file from <http://www.camozzi.com> and proceed with installation following the on-screen instructions. For more details, please refer to the **QSet** manual.  
The connection to the DRCS drive is standard Micro USB (available as an accessory: G11W-G12W-2); communication is only possible if the USB driver is correctly installed on PC.  
The USB driver is installed automatically during the **QSet** installation.

**7.11 PC requirements**

CPU	2.0 GHz or higher
RAM	2 GB or higher
HD space	600 MB or higher
Communication port	USB 2.0
Operative system	Windows 7, Windows 8
Screen resolution	1280x720

- On start-up of the **QSet** software, the system verifies communication between the DRCS drive and the PC where the configuration software is installed. In the event of communication failure, an error message is displayed.





Type of fault	Cause	Solution
Communication failure between DRCS drive and PC	Power supply not connected	Connect the electrical power supply
	USB cable not connected	Connect the USB cable to one of the ports available on the PC and to the Micro USB connector
	USB driver not installed	Contact the Camozzi technical assistance service

## 8. Operation











- Ensure that the electrical power supply and all other operating conditions remain within their specified range.
- The product may only be used in accordance with the specifications provided; if these requirements are not met, the product may only be used with authorization from Camozzi.
- Observe the specifications on the nameplate.

## 9. Troubleshooting and/or exceptional circumstances

- The following table explains the indication of the LED on the top panel of the DRCS drive:

Led	Problem	Solution
 OFF	The logic power supply is not present	Check the power supply connector LOGIC 24V
 Solid	The DRCS drive is powered and the connected motor is disabled	
 Blink 0,5 HZ	The DRCS drive is powered and the connected motor is enabled	
 Blink 1 HZ	The DRCS drive is powered, the connected motor is enabled and the Homing procedure is completed	
 Fast blink	An alarm is present	Identify the type of alarm according to the number of times the LED flashes (described below)

- The following table describes the LED indication of alarms:

Led	Description	Drive status
	solid	Motor disabled
	flashing slow (0,5Hz)	Motor enabled without homing
	flashing normal (1Hz)	Motor ready to move (enabled + homing completed)
	flashing 1 time	Alarm: motor not configured
	flashing 2 times	Alarm: Homing
	flashing 3 times	Alarm: overflow limit
	flashing 4 times	Alarm: undervoltage
	flashing 5 times	Alarm: thermal
	flashing 6 times	Alarm: overcurrent
	flashing 7 times	Alarm: step lost (if encoder is present)
	flashing fast (>1Hz)	Alarm: on serial communication

## 10. Limitations on use

- Never exceed the technical specifications stated in the paragraph “General characteristics” and the Camozzi general catalogue.
- With the exception of specific intended applications, do not use the product in environments where there is the risk of direct contact with corrosive gases, chemical products, salt water, water or steam.
- Do not install the DRCS drive in spaces where air recirculation is not limited, as the fan will not be able to maintain an environment below 40°C.
- Do not install the DRCS drive in areas with high levels of humidity.

## 11. Maintenance

- If maintenance is performed incorrectly, it can affect proper operation of the device and it could cause harm or damage to persons or objects in its vicinity.
- Check that all components are secure and disconnect the power supply to release residual charge from the system before performing work.
- Check whether it is possible to have the product serviced at a technical assistance centre.
- Never disassemble a live unit.
- Shut off electric supplies before maintenance.
- Always remove accessories before maintenance.
- Always wear the correct personal protective equipment as required by local authorities and in compliance with current legislation.
- If replacement of worn parts is required, use only the original Camozzi kit and ensure that the work is performed by specialised and authorised personnel. Otherwise, product certification will be rendered invalid.

## 12. Environmental notes

- At the end of the product's life cycle, separate the components into their respective material types for recycling.
- Comply with all current standards and local regulations regarding waste disposal.
- The product and its components are in compliance with the standards ROHS and REACH.

## Contacts

### **Camozzi Automation spa**

Società Unipersonale  
Via Eritrea, 20/I  
25126 Brescia - Italy  
Tel. +39 030 37921  
Fax +39 030 2400430  
info@camozzi.com  
www.camozzi.com

### **Technical assistance**

Product inquiries and  
requests for support  
Tel. +39 030 3792790  
service@camozzi.com

### **Product Certification**

Information concerning  
product certifications, EC standards,  
conformity declarations and instructions  
productcertification@camozzi.com

## *Camozzi Worldwide*

Details about our sales network can be found  
on the Camozzi website in the Contacts section



5000002102 rev.A

