

# USE AND MAINTENANCE MANUAL

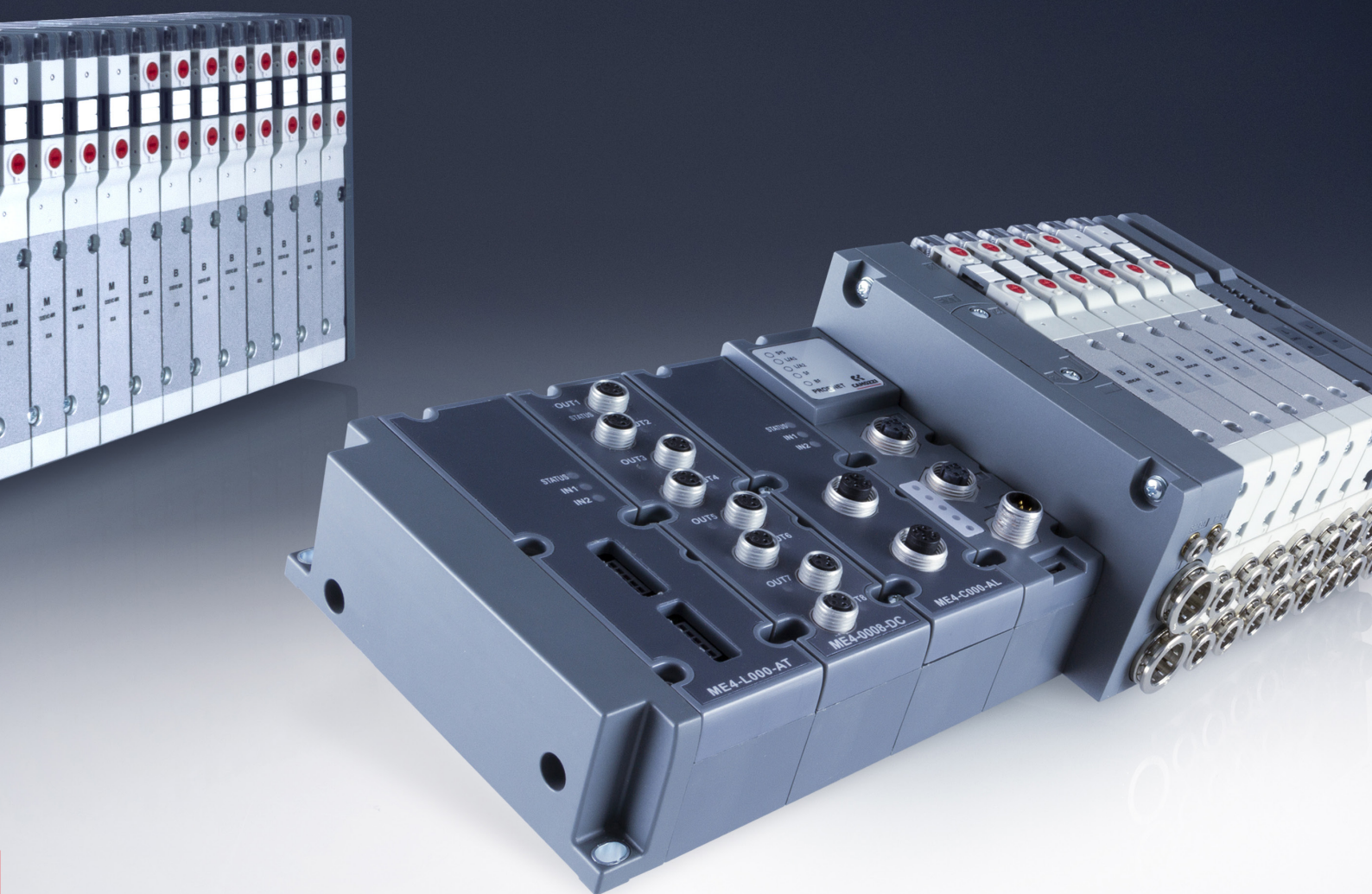

## SERIES D SERIES CX4 PROFINET 1.1



# Contents

<b>1</b>	<b>General recommendations</b>	<b>1</b>
1.1	Product storage and transport . . . . .	2
1.2	Use . . . . .	2
1.3	Limitations of use . . . . .	2
1.4	Maintenance . . . . .	2
1.5	Ecological Information . . . . .	3
<b>2</b>	<b>General characteristics and conditions of use</b>	<b>4</b>
<b>3</b>	<b>General description of the system</b>	<b>6</b>
<b>4</b>	<b>Recipients</b>	<b>7</b>
<b>5</b>	<b>Installation</b>	<b>8</b>
5.1	General installation instructions . . . . .	8
5.2	Connecting and warning components . . . . .	8
5.2.1	Power Supply Connector . . . . .	8
5.2.2	Connector to the PROFINET/IO network . . . . .	9
5.2.3	USB Connector . . . . .	10
5.3	Power supply . . . . .	11
5.3.1	Electropilot activation rules . . . . .	11
5.4	Connectable accessories . . . . .	12
5.5	Assembly . . . . .	13
5.5.1	Dismantling and fitting CX4 module . . . . .	13
5.5.2	Series D subbases assembly . . . . .	14
5.5.3	Dismantling and fitting Serie D coil valves . . . . .	15
5.5.4	I/O modules assembly . . . . .	16
5.5.5	Dismantling and fitting I/O modules . . . . .	17
<b>6</b>	<b>Accessories</b>	<b>18</b>
6.1	Series D valve subbase . . . . .	18
6.1.1	Technical Data . . . . .	19
6.1.2	Coilvision . . . . .	19
6.1.3	Features . . . . .	20
6.1.4	Subbase diagnostics . . . . .	20
6.2	Digital Input Module . . . . .	22
6.2.1	Features . . . . .	22
6.2.2	Connections and signals of the 8 digital input module (M8 version) . . . . .	23
6.2.3	Connections and signals of the 8 digital input module (M12 version) . . . . .	24
6.2.4	Connections and signals of the 16 digital input modules . . . . .	25
6.2.5	Module diagnostics . . . . .	27
6.3	Digital Output Module . . . . .	30

6.3.1	Features . . . . .	30
6.3.2	Connections and signals of the 8 digital output modules (M8 version) . . . . .	32
6.3.3	Connections and signals of the 8 digital output modules (M12 version) . . . . .	33
6.3.4	Connections and signals of the 16 digital output modules . . . . .	34
6.3.5	Module diagnostics . . . . .	36
6.4	Analogue Input Module . . . . .	39
6.4.1	Data format . . . . .	39
6.4.2	Features . . . . .	40
6.4.3	Connections and signals of the modules . . . . .	42
6.4.4	Module diagnostics . . . . .	43
6.4.5	RTD Module (Resistance Temperature Detector) . . . . .	46
6.4.6	Thermocouple module . . . . .	48
6.4.7	Bridge module . . . . .	50
6.4.8	Voltage/Current module . . . . .	53
6.5	Analogue Output Module . . . . .	56
6.5.1	Data format . . . . .	57
6.5.2	Features . . . . .	57
6.5.3	Connections and signals of the modules . . . . .	58
6.5.4	Module diagnostics . . . . .	59
<b>7</b>	<b>Commissioning</b>	<b>61</b>
7.1	Electrical connections . . . . .	61
7.2	Start-up operation . . . . .	61
7.3	Mapping . . . . .	62
7.4	PROFINET/IO name assignment . . . . .	62
7.5	Configuration via GSDML file . . . . .	63
7.6	Address assignment . . . . .	64
7.7	Cyclical data . . . . .	66
7.8	Acyclic data . . . . .	67
7.8.1	Read variables . . . . .	67
7.8.2	Commands . . . . .	68
7.8.3	Module parameterisation . . . . .	69
7.8.3.1	Modulo CX4 PROFINET/IO . . . . .	69
7.8.3.2	Series D valve subbases . . . . .	70
7.8.3.3	Digital inputs . . . . .	71
7.8.3.4	Digital outputs . . . . .	72
7.8.3.5	Analogue inputs . . . . .	73
7.8.3.6	Analogue outputs . . . . .	81
7.9	MRP Support . . . . .	82
<b>8</b>	<b>Diagnostic</b>	<b>83</b>
8.1	CX4 module . . . . .	85
8.1.1	PROFINET/IO node . . . . .	85
8.1.2	CX4 system diagnostics . . . . .	86

8.1.3	Replace solenoid valve . . . . .	89
8.1.4	Fieldbus fatal error . . . . .	89
8.1.5	Over-temperature alarm . . . . .	89
8.1.6	Undervoltage alarm . . . . .	89
8.1.7	I/O module mapping error . . . . .	89
8.1.8	Solenoid valve mapping error . . . . .	89
8.1.9	No mapping . . . . .	90
8.1.10	Solenoid valve or I/O module alarms . . . . .	90
8.2	Series D valve subbases . . . . .	91
8.3	Digital Input Module . . . . .	93
8.4	Digital Output Module . . . . .	94
8.5	Analogue Input Module . . . . .	96
8.6	Analogue Output Module . . . . .	98
<b>9</b>	<b>Uvix</b>	<b>100</b>
9.1	Introduction . . . . .	100
9.2	General information . . . . .	101
9.2.1	Status information . . . . .	102
9.2.2	PROFINET/IO network configuration . . . . .	103
9.2.3	Variables . . . . .	104
9.2.4	Alarms . . . . .	105
9.2.5	Commands . . . . .	106
9.3	Series D coil valves and subbase . . . . .	107
9.3.1	Status information . . . . .	107
9.3.2	Configuration . . . . .	108
9.3.3	Details . . . . .	109
9.3.4	Variables . . . . .	109
9.3.5	Alarms . . . . .	110
9.3.6	Commands . . . . .	111
9.4	Digital Input Module . . . . .	112
9.4.1	Status information . . . . .	112
9.4.2	Configuration . . . . .	113
9.4.3	Variables . . . . .	114
9.4.4	alarms . . . . .	114
9.5	Digital Output Module . . . . .	115
9.5.1	Status information . . . . .	115
9.5.2	Configuration . . . . .	115
9.5.3	Variables . . . . .	117
9.5.4	Allarmi . . . . .	118
9.5.5	Comands . . . . .	119
9.6	Analogue Input Module . . . . .	120
9.6.1	Status information . . . . .	120
9.6.2	Configuration . . . . .	120

## CONTENTS

9.6.3	Variables . . . . .	123
9.6.4	Alarms . . . . .	124
9.7	Analogue Output Module . . . . .	125
9.7.1	Status information . . . . .	125
9.7.2	Configuration . . . . .	126
9.7.3	Variables . . . . .	127
9.7.4	Alarms . . . . .	127
9.7.5	Commands . . . . .	128
9.8	UVIX USB Gateway . . . . .	129
9.8.1	Main page . . . . .	129
9.8.2	WiFi network configurator . . . . .	130
9.8.3	Mapping . . . . .	130
9.8.4	Firmware update . . . . .	130
9.9	Communication with external applications . . . . .	134
<b>10</b>	<b>NFCamApp</b>	<b>138</b>
10.1	Main overview . . . . .	138
10.2	Main page . . . . .	139
10.3	General information . . . . .	140
10.4	WiFi information . . . . .	141
10.5	Fieldbus configuration . . . . .	142
10.6	Mapping request . . . . .	143
<b>11</b>	<b>Contacts</b>	<b>144</b>

# General recommendations

▲ Please comply with the recommendations for safe use described in this document:

- Some hazards can only be associated with the product after it has been installed on the machine/equipment. It is the responsibility of the end user to identify these hazards and reduce the risks associated with them.
- For information regarding the reliability of the components, contact Camozzi Automation.
- Read the information in this document carefully before using the product.
- Keep this document in a safe place and close at hand for the whole of the product's life cycle.
- Pass this document on to any subsequent owner or user.
- The instructions in this manual must be observed in conjunction with the instructions and additional information concerning the product in this manual, available from the following reference links:
  - Website <http://www.camozzi.com>
  - Camozzi general catalogue
  - Technical assistance service
- Assembly and commissioning must be performed exclusively by qualified and authorised personnel on the basis of these instructions.
- It is the responsibility of the system/machine designer to ensure the correct selection of the most suitable pneumatic component according to the intended application.
- Use of appropriate personal protective equipment is recommended to minimise the risk of physical injury.
- For all situations not contemplated in this manual and in situations in which there is the risk of potential damage to property, or injury to persons or animals, contact Camozzi for advice.
- Do not make unauthorised modifications to the product. In this case, any damage or injury to property, persons or animals will be the responsibility of the user.
- It is recommended to comply with all safety regulations that apply to the product.
- Never intervene on the machine/system until you have verified that all working conditions are safe.
- Before installation or maintenance, ensure that the required safety locks are active, and then disconnect the electrical mains (if necessary) and system pressure supply, discharging all residual compressed air from the circuit and deactivating residual energy stored in springs, condensers, recipients and gravity.
- After installation or maintenance, the system pressure and electrical power supply (if necessary) must be reconnected, and the regular operation and sealing of the product must be checked. In the event of leaks or malfunction, the product must not be used.
- The product may only be used in observance of the specifications provided; if these requirements are not met, the product may only be used upon authorisation by Camozzi.
- Avoid covering the equipment with paint or other substances that may reduce heat dissipation.

## 1.1 Product storage and transport

- Adopt all measures possible to avoid accidental damage to the product during transport, and when available use the original packaging.
- Observe the specified storage temperature range of  $-10 \div 50$  °C.

## 1.2 Use

- Make sure that the distribution network voltage and all operating conditions are within the permissible values.
- The product may only be used in observance of the specifications provided; if these requirements are not met, the product may only be used upon authorisation by Camozzi.
- Follow the indications shown on the identification plate.

## 1.3 Limitations of use

- Do not exceed the technical specifications given in paragraph 2 (General characteristics and conditions of use) and in the Camozzi general catalogue.
- Do not install the product in environments where the air itself may cause hazards.
- With the exception of specific intended uses, do not use the product in environments where direct contact with corrosive gases, chemicals, salt water, water or steam may occur.

## 1.4 Maintenance

- Incorrectly performed maintenance operations can compromise the good working order of the product and harm surrounding persons.
- Check conditions to prevent sudden release of parts, then suspend the power supply and allow residual stresses to discharge before taking action.
- Assess the possibility of having the product serviced by a technical service center.
- Never disassemble a live unit.
- Isolate the product electrically before maintenance.
- Always remove accessories before maintenance.
- Always wear the correct personal protective equipment as envisaged by local authorities and in compliance with current legislation.
- In the event of maintenance, or replacement of worn parts, exclusively use the original Camozzi kits and ensure that operations are performed by specialised and authorised personnel. Otherwise product approval will be rendered invalid.

## **1.5 Ecological Information**

- At the end of the product's life cycle, it is recommended to separate the materials for recycling.
- Follow the waste disposal regulations in force in your country.
- The product and relative parts all comply with the ROHS and REACH standards.



# General characteristics and conditions of use

<b>ELECTRICAL SECTION</b>	
Power and bus connection type	M12 - 5 poles
Supply voltage Logic	24 V DC +/-25%
Supply voltage Power	24 V DC +/-10%
Valve maximum absorption	2.5 A
Maximum no. valve positions	64 (128 coils)
Coil power	1W (reduction to 0.5W after 100ms)
Maximum cable length	20 m
Selectable Slave address	From 1 to 127
Protocol	PROFINET/IO 

PNEUMATIC SECTION					
Versions		D1	D2	D4	D5
Valve construction		Spool with seals			
Valve functions		5/2 monostable and bistable		2x3/2 NC 2x3/2 NO	
		5/3 CC – CP – CO		1X3/2 NC+1X3/2 NO	
Materials	Body	Aluminium			
	Spool	Aluminium			
	Subbase	Technopolymer	Technopolymer	Aluminium	Technopolymer
	End cover	Technopolymer			
	Seal	HNBR			
Connections		Uses 2 and 4			
		Thread (only D4) or bushings, tube size variable according to the pitch			
Temperature		0 ÷ 50 °C			
Air feature		Compressed air filtered and not lubricated in class 7.4.4 according to ISO 8573-1: 2010. If lubrication is required, use only oils with max. viscosity. 32 Cst and the version with external servo drive. The servo drive air quality must be in class 7.4.4 according to ISO 8573-1: 2010 (do not lubricate).			
Valve pitch		10.5 mm	16 mm	25 mm	10.5 e 16 mm
Working pressure		-0.9 ÷ 10 bar			
Drive pressure		2.5 ÷ 7 bar 4,5 ÷ 7 bar (with working pressure higher than 6 bar for the 2x3/2 version)			
Flow rate		250 NL/min	950 NL/min	2000 NL/min	250 ÷ 950 NL/min
Assembly position		Any			
Degree of protection		IP65			

# General description of the system

The CX4 PROFINET/IO module is a device for driving valves and/or managing digital and/or analogue I/O by connecting it to a PROFINET/IO network. The CX4 consists of power connectors, input and output connectors for the PROFINET/IO field bus and LEDs for system diagnostics. It is possible to connect the Series D coil valves on the right side of the CX4, while on the left side it is possible to connect the digital and analogue I/O modules.

---

## Nomenclature

The CX4 module can be used by just connecting the input and output modules; in this case the device will take the name of **Series CX4 Stand Alone** module. If coil valves (with or without I/O modules) are connected to the CX4 on the pneumatic side, the device becomes a valve island and is called **Series D Valve Island Field-bus**.

---

The CX4 module, both in Series CX4 and Series D valve island fieldbus configurations, is a solution dedicated to Industry 4.0 because it is a *SMART* device capable of connecting to other devices or networks (ex. WiFi, USB, NFC) for information exchange. The system can transmit data of the main variables, the diagnostics of all the components of which the island is made. In addition, the system can configure the island and each connected module. The smart interfaces with the system are:

- **Camozzi UVIX** (*Universal Visual Interface*), a software that can be installed on a PC/server/gateway used by USB or included in a company network and accessible from other PCs (cap. 9).



- **NFCamApp** (*NFC Camozzi Application*), smartphone application for Android and iOS (cap. 10).

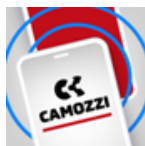

**NOTE.** In addition, in the Series D Serial valve island configuration, the system has **COILVISION** technology which monitors the correct operation of the coil valve. Each actuation of the coil, in different cyclic configurations and environmental conditions, is analysed to acquire information which, when processed by software algorithms, allows the health of the component to be diagnosed and predicted (par. 6.1.2).

# Recipients

The manual is intended exclusively for qualified experts in control and automation technologies who have experience in the installation, commissioning, programming and diagnostics of programmable logic controllers (PLCs) and fieldbus systems.

# Installation

## 5.1 General installation instructions

For reasons of operator safety and to prevent functional damage to the system, before starting any installation or maintenance operation, disconnect:

- The air supply.
- The power supply of the control electronics and outputs/coil valves.

## 5.2 Connecting and warning components

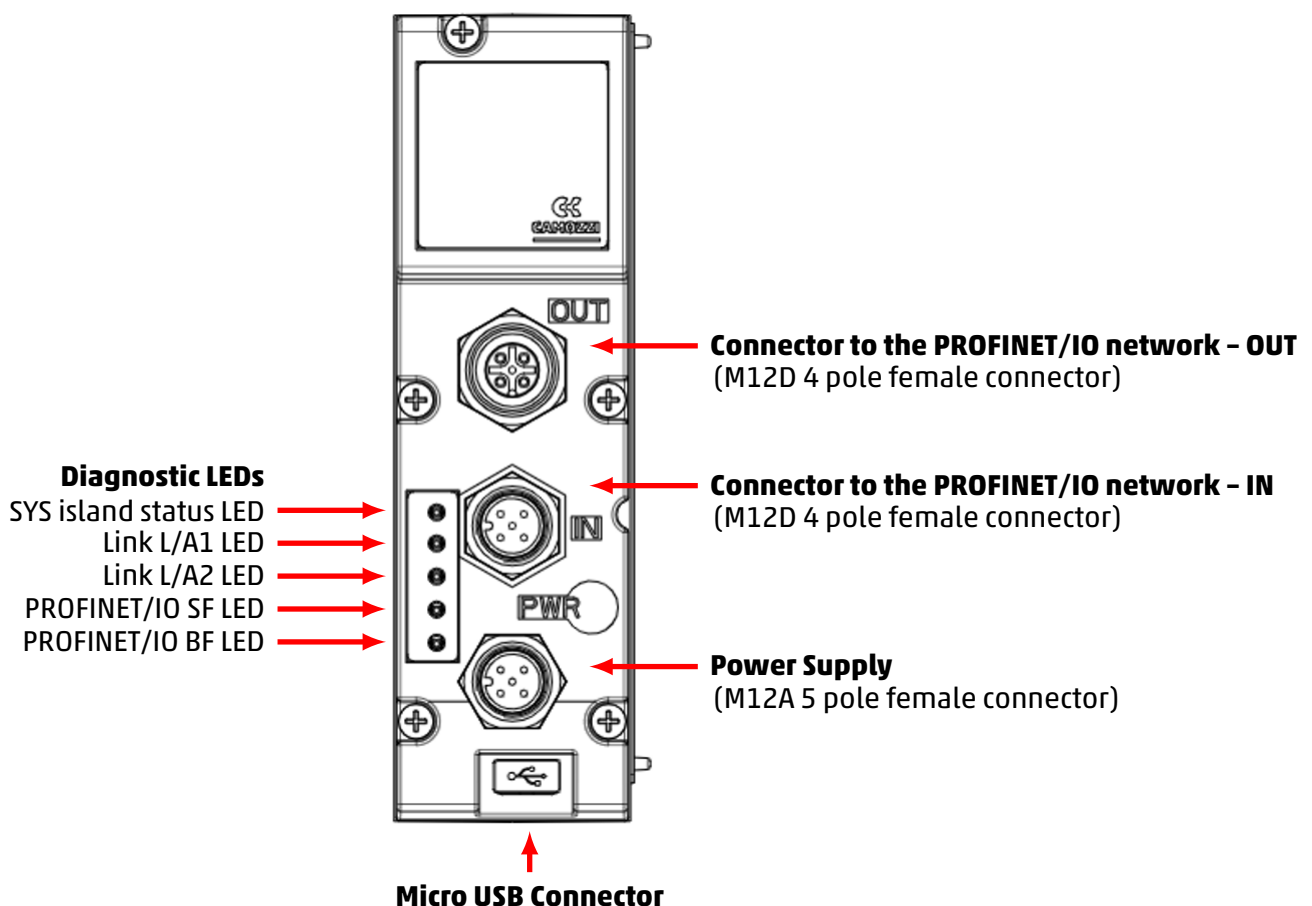

### 5.2.1 Power Supply Connector

The Power Supply connector is a 5-pole M12A male.

**NOTE.** To connect the system to the mains it is recommended to use the connectors from the Camozzi catalogue:

- CS-LF04HB, straight connector for power supply.

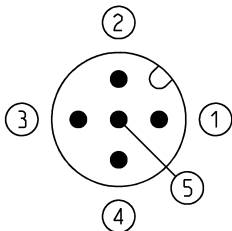
PIN	Signal	Description	Symbol
1	L24V	24 Vdc power supply (logic, digital inputs, analogue I/O): connect to the positive pole of the 24 Vdc power supply (referred to GND).	
2	P24V	24 Vdc power supply (digital outputs and valves): connect to the positive pole of the 24 Vdc power supply (referred to GND).	
3	GND	Common (reference pin 1 and 2): connect to the negative pole of the 24 Vdc power supply (compulsory).	
4	EARTH	Earth connection	
5	NC	Not Connected	

### 5.2.2 Connector to the PROFINET/IO network

The connectors for the PROFINET/IO network (IN and OUT) are M12D 4-pole female.

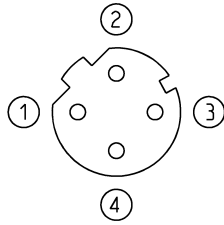
PIN	Signal	Description	Symbol
1	TD+	Transmission data (+)	
2	RD+	Reception data (+)	
3	TD-	Transmission data (-)	
4	RD-	Reception data (-)	

**NOTE.** To avoid malfunctions due to faulty wiring, it is recommended to connect the system to the network using the pre-wired PROFINET/IO cables from the Camozzi catalogue:

- CS-SB04HB-D100, co-moulded cable with straight M12D connector, length 1m.
- CS-SB04HB-D500, co-moulded cable with straight M12D connector, length 5m.
- CS-SB04HB-DA00, co-moulded cable with straight M12D connector, length 10m.

To connect to the controller, the following cable from the Camozzi catalogue can be used:

- CS-SE04HB-F500, co-moulded cable with RJ45 – M12D connector.

### 5.2.3 USB Connector

The USB communication connector is a standard micro version. The connector allows the CX4 to be connected to the UVIX interface for monitoring or configuration.

**NOTE** The dedicated USB connector can be found in the Camozzi catalogue:

- G11W-G12W-2, standard cable with micro-USB connector length 2m.

### 5.3 Power supply

The power supply is separated into *logic* (L24V), which allows the communication buses, the subbases of the pneumatic part and the I/O modules to be powered, and into *power* (P24V), which powers the valves and digital outputs. Therefore, for the system to work, it is essential to connect the logic power supply, otherwise the CX4 remains off. The two separate power supplies make it possible, if necessary, to disconnect the power supply to the valves while the bus power line remains active. The lack of power supply is signalled by the flashing red SYS island status LED. This problem is also signalled through a message via the network to provide for proper alarm management.

If the loads or inputs connected to the initial node require tighter tolerances of the supply voltage value, the node power supply voltage must respect these.

**NOTE.** The nominal power supply voltage of the CPU module is 24 Vdc  $\pm$ 10%.

#### 5.3.1 Electropilot activation rules

In normal standard operation, the coil valves are activated, for 100 ms, with a power of 1 W (@ 24 V the absorbed current is therefore 41.6 mA). Subsequently, the coil valves are kept activated by reducing the absorbed power to 50% of the initial value, by means of a PWM control technique. The permitted power supply voltage for the series D valve island is 24 Vdc  $\pm$  10%, therefore the useful range is 21.6 Vdc  $\div$  26.4 Vdc. The currents absorbed by the coil valve coils corresponding to the power supply range are 39 mA  $\div$  48 mA (in typical conditions) in the first 100 ms of activation and subsequently 19.5 mA  $\div$  24 mA in the power reduction phase due to the use of PWM. The continuous operation of the valve island is guaranteed for a maximum absorption of 2.5 A. In the worst conditions (maximum current absorption for 26.4 Vdc power supply) it is possible to activate up to 50 coils simultaneously with all the valves of the island off. Subsequently, it is possible to proceed by using the following formula:

$$\text{No. of coils to be controlled simultaneously} = 50 - (0,6 \times \text{No. active coils})$$

---

#### Example

- If 10 coils are already active, 44 coils can be activated simultaneously.
- If 20 coils are already active, 38 coils can be activated simultaneously.

---

**NOTE.** The maximum number of simultaneously active coils is 80. Each subsequent activation with respect to the previous group of coils must happen after 150 ms.



## 5.4 Connectable accessories

Series D pneumatic coil valves or I/O modules can be connected to the CX4 module. Here is the complete list of devices that can be connected to the CX4, with the respective references to the technical details in the manual.

- Series D subbase and coil valves in three different sizes (par. 6.1).
- 8- or 16-channel digital input module (par. 6.2).
- 8- or 16-channel digital output module (par. 6.3).
- Analog input module (par. 6.4):
  - RTD module (par. 6.4.5).
  - Thermocouple module 6.4.6).
  - Bridge module (par. 6.4.7).
  - Voltage/Current module (par. 6.4.8).
- Analog output module (par. 6.5).

### 5.5 Assembly

#### 5.5.1 Dismantling and fitting CX4 module

Dismantle the CX4 module as follows:

1. Switch off the power supply of the CX4 module to avoid problems for the device or user.
2. Loosen the 5 screws.
3. Pull the cover of the CX4 module carefully and without tilting from the manifold base.

Fit the CX4 module as follows:

1. Switch off the operating voltage supply of the CX4 module to avoid problems for the device or user.
2. Make sure that the gaskets are tight and not damaged.
3. Push the cover of the CX4 module carefully and without tilting as far as possible into the manifold base.
4. Tighten the 5 screws (Torque max 0.6 Nm).

**NOTE.** After an island modification, the mapping procedure is required (par. 7.3).

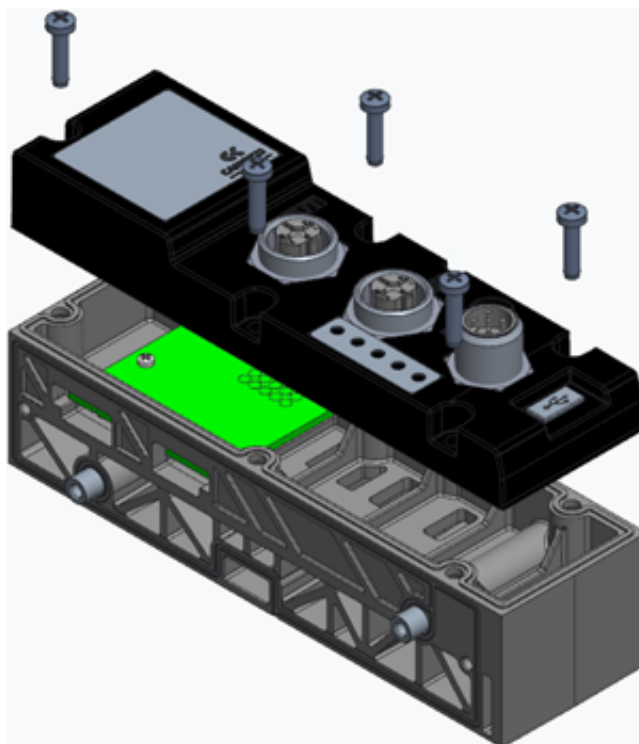

### 5.5.2 Series D subbases assembly

Dismantle and fit the Series D subbases as follows:

1. Switch off the power supply of the CX4 module to avoid problems for the device or user.
2. Unscrew the 3 screws to the cover at the end of the island and open the valves subbases pack.
3. Remove the valves subbases from the tie-rods and replace with the new modules.
4. Push the valves subbases as far as possible to allow a correct electrical contact.
5. Mount the cover at the end of the island and tighten the 3 screws (Torque max 0.9 Nm)

**NOTE.** The mapping procedure must be carried out in all those cases in which the valve subbases are added, removed, or moved (par. 7.3).

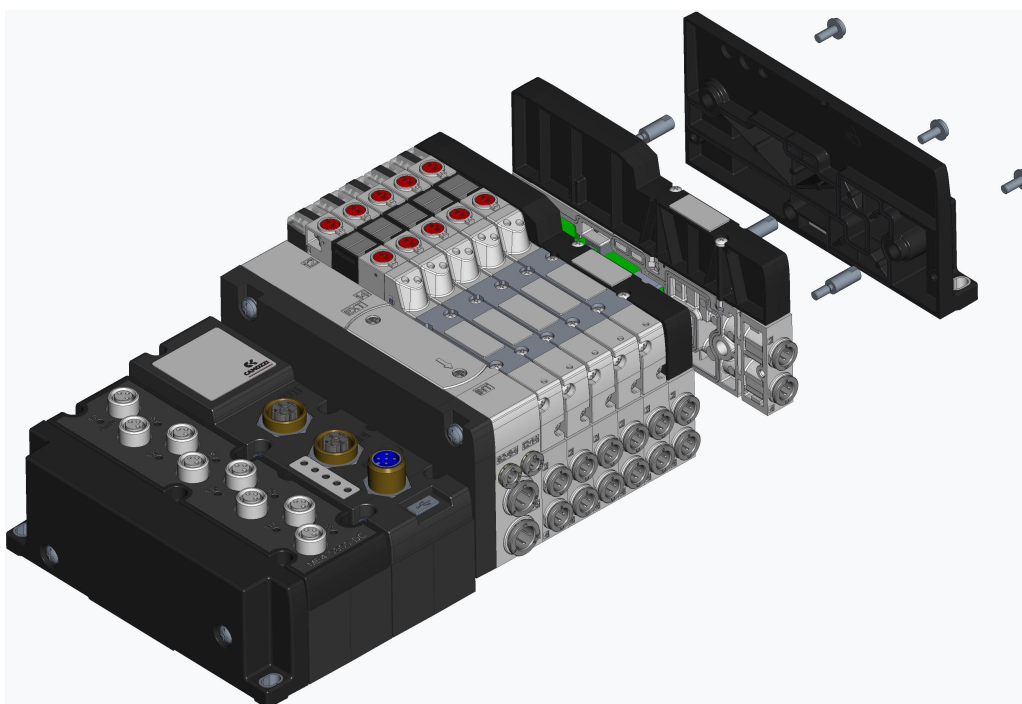

\* Example for Series D1 Valve Island.

### 5.5.3 Dismantling and fitting Serie D coil valves

Dismantle and fit the Serie D coil valves on the same size subbases as follows:

1. Unscrew the 2 screws above the Serie D coil valves.
2. Pull the valves carefully and without tilting from the subbase to avoid damages.
3. Add the new valves carefully and without tilting to the subbase to avoid damages.
4. Tighten the 2 screws (Torque max 0.25 Nm (D1/D5), 0.5 Nm (D2), 2.0 Nm (D4)).
5. Reset the subbase information from UVIX interface or controller/PLC.

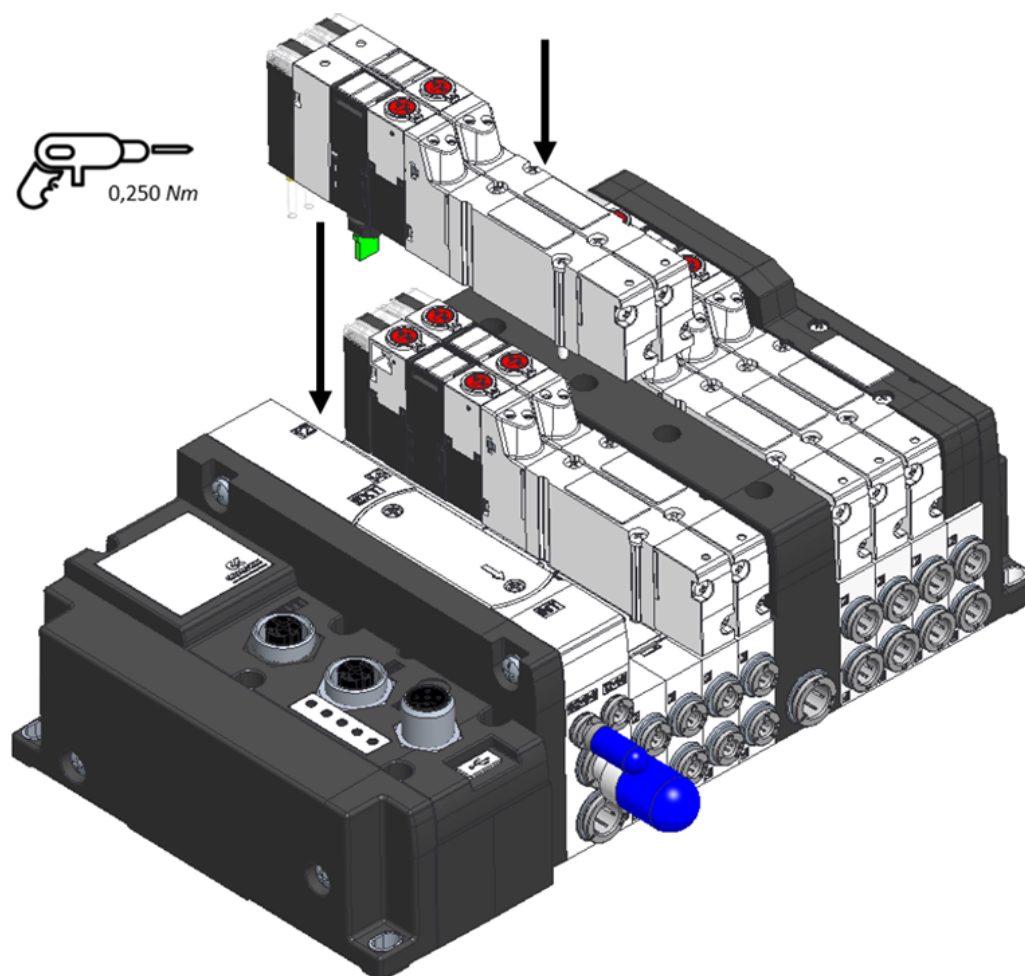

\* Example for Series D1 Valve Island.

### 5.5.4 I/O modules assembly

Dismantle and fit the I/O modules as follows:

1. Switch off the power supply of the CX4 module to avoid problems for the device or user.
2. Unscrew the 2 screws to the cover at the end of the island and open the I/O pack.
3. Remove the I/O modules from the tie-rods and replace with the new modules.
4. Push the I/O modules as far as possible to allow a correct electrical contact.
5. Mount the cover at the end of the island and tighten the 2 screws (Torque max 0.9 Nm)

**NOTE.** The mapping procedure must be carried out in all those cases in which the I/O modules are added, removed, or moved (par. 7.3).

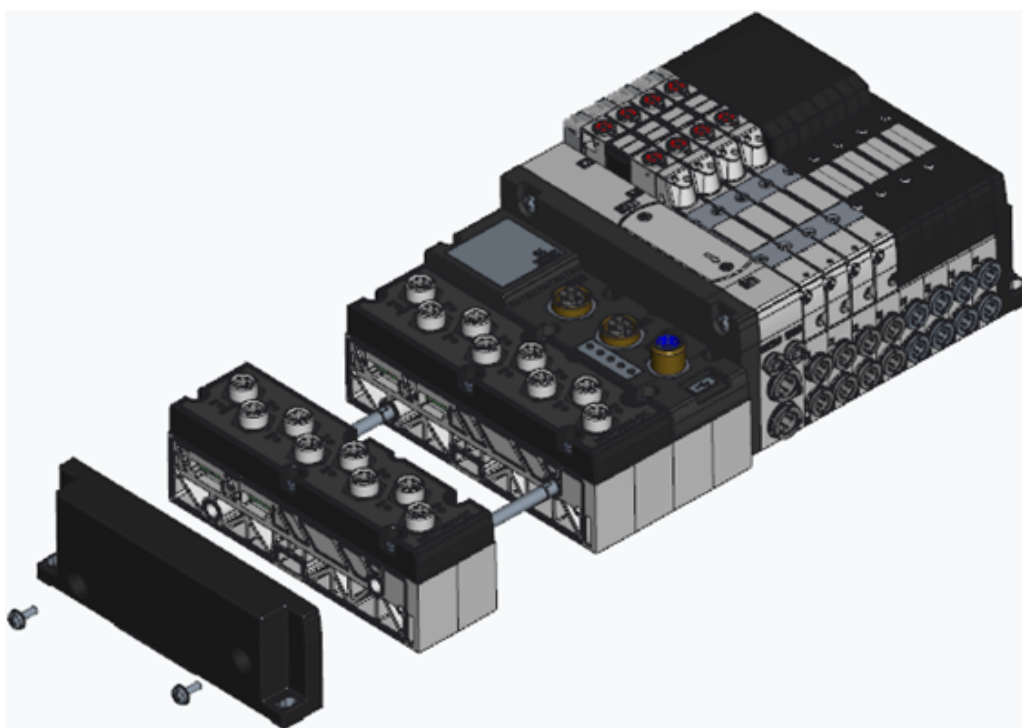

\* Example for Series D1 Valve Island.

### 5.5.5 Dismantling and fitting I/O modules

Dismantle the cover of the I/O module as follows:

1. Switch off the power supply of the CX4 module to avoid problems for the device or user.
2. Loosen the 5 screws.
3. Pull the cover of the I/O module carefully and without tilting from the manifold base.

Fit the cover of the I/O module as follows:

1. Switch off the operating voltage supply of the CX4 module to avoid problems for the device or user.
2. Make sure that the gaskets are tight and not damaged.
3. Push the cover of the I/O module carefully and without tilting as far as possible into the manifold base.
4. Tighten the 5 screws (Torque max 0.6 Nm).

**NOTE.** After an island modification, the mapping procedure is required (par. 7.3).

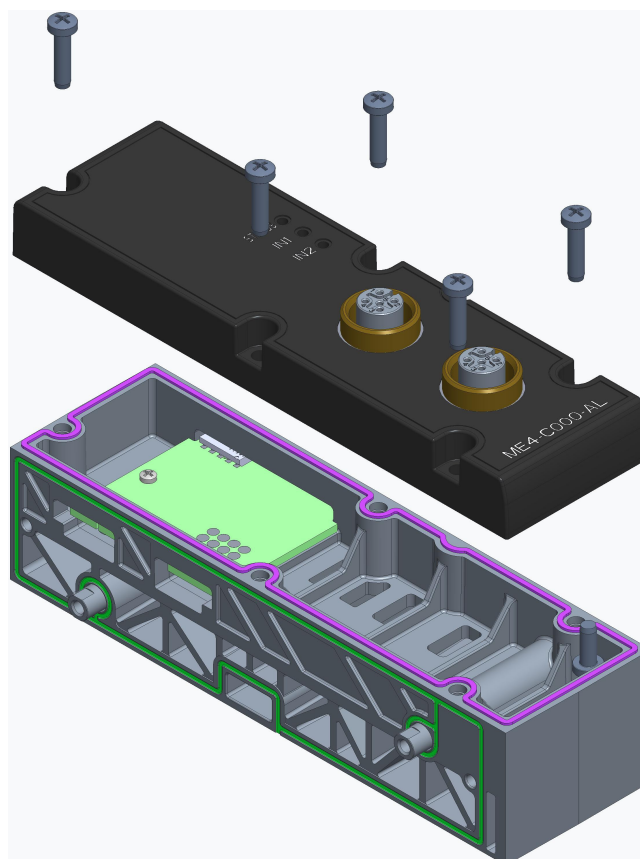

# Accessories

## 6.1 Series D valve subbase

The CX4 can be used to create a Series D Serial valve island by connecting the subbases on the pneumatic side to allow the new Camozzi Series D coil valves to be connected.

Series D valves are available in three sizes depending on the pitch:

- Series D1 coil valves, 10.5 mm pitch

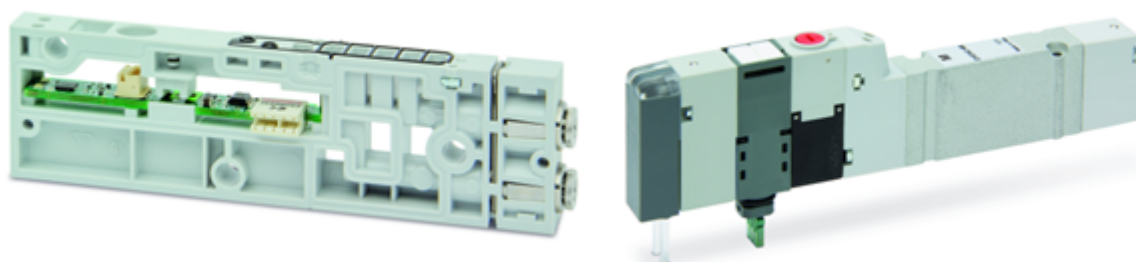

- Series D2 coil valves, 16 mm pitch

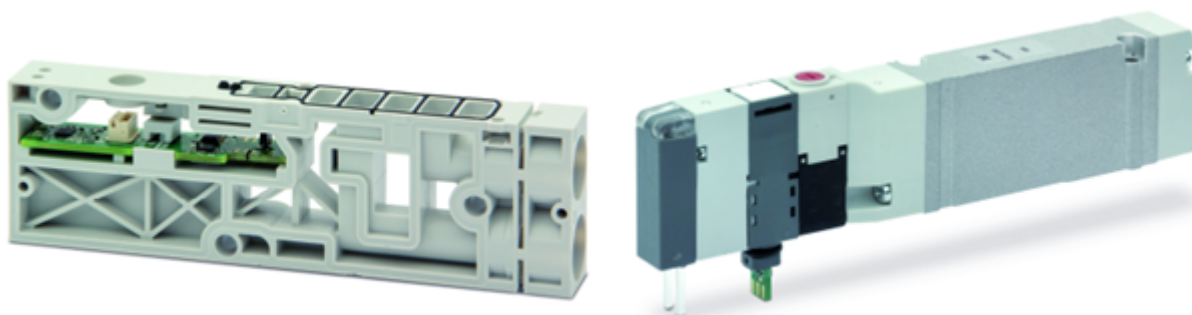

- Series D4 coil valves, 25 mm pitch

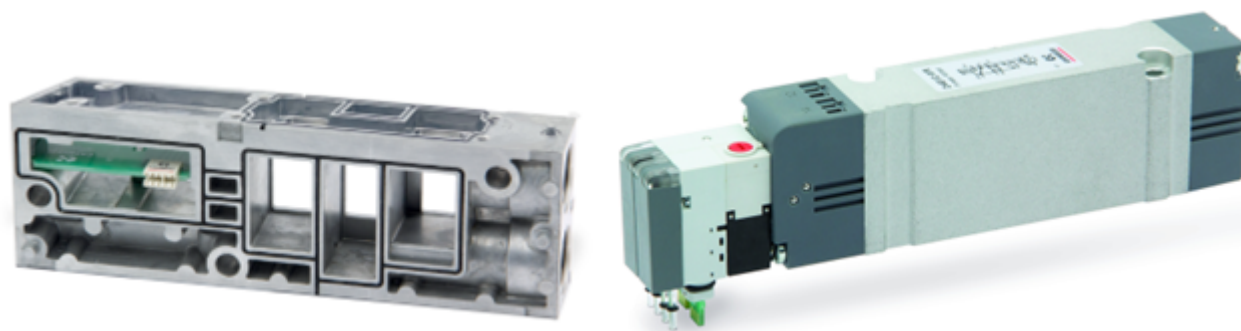

**6.1.1 Technical Data**

Key feature	Value
Construction	Balanced spool
Valve functions	2x3/2 NC/NO/NC+NO; 5/2; 5/3 CC/CO/CP
Materials	body, spool= AL; bases, end cover = technopolymer; bases = AL only D4; seals = HNBR
Attachments	Variable Bushings Ø (D1-D2-D5) Thread G3/8 (D4)
Ambient temperature	0÷50 °C
Fluid	<ul style="list-style-type: none"> <li>• Compressed air filtered and not lubricated in class 7.4.4 according to ISO 8573-1: 2010.</li> <li>• If lubrication is required, use only oils with max. viscosity. 32 Cst and the version with external servo drive.</li> <li>• The servo drive air quality must be in class 7.4.4 according to ISO 8573-1:2010.</li> </ul>
Voltage	24 Vdc
Voltage tolerance	±10%
Absorption	1 W
Insulation class	class F

**6.1.2 Coilvision**

The subbases of Series D valves are equipped with **COILVISION** technology. This technology was developed to constantly monitor the functional parameters of the coil that drives the spool. Each actuation of the coil, in different cyclic configurations and environmental conditions, is analysed to acquire information which, when processed by software algorithms, allows the health of the component to be diagnosed and predicted.

The information on the health status of the solenoid valve is data supplied by the CX4 module to the PLC and via the UVIX browser interface in the form of a percentage and gauge indicator (par. 9.3.4). Via UVIX, you can also receive a replace solenoid valve warning when its performance has deteriorated (par. 9.3.5). Below is all the information that can be obtained through COILVISION technology.



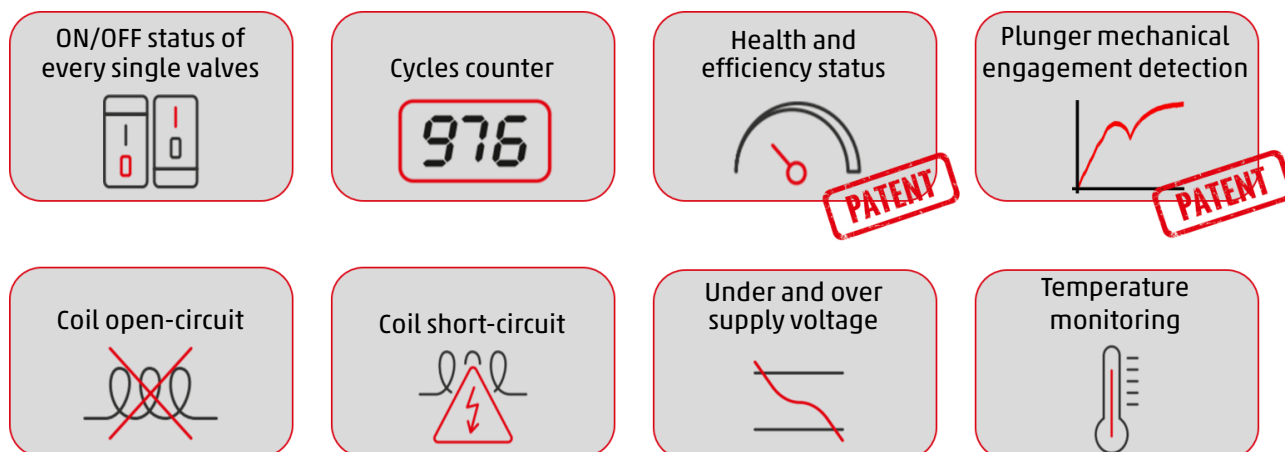

### 6.1.3 Features

The subbases that control the Series D coil valves can be configured in the management of the failsafe operation and in the management of piloting errors in the coil valves themselves .

Failsafe allows the subbase, in the absence of communication with the CX4 module, to set the status of the commands that drive the coil valves in order to avoid harmful and dangerous situations for devices or users. The parameters that can be configured are the ability to enable failsafe (*Fail Safe Enable*), which is disabled by default, and the state you want to set the valve coils to (*Fail Safe Status*). By default, the coil is off.





Coil management error locking can also be enabled (*Error Enable*). By default it is disabled. If enabled, errors do not simply disappear with the deactivation of the coil but the whole subbase and subsequently the whole system must be restarted.

**NOTE.** Possible errors on the coils are described in paragraph 6.1. Coil interrupt and coil over-current alarms can be configured as blocking.

### 6.1.4 Subbase diagnostics

The diagnostics of the subbases for the coil valves are defined by coded flashing of the yellow LED associated with the single coil (the subbase D4 is associated to two yellow LEDs with the same behaviour for each single coil).

Module status and alarms	LED status	Description of the status and solutions of the alarms
Normal operation without alarms	YELLOW OFF	The valve is not controlled.
	YELLOW ON	The valve has been operated correctly.

Module status and alarms	LED status	Description of the status and solutions of the alarms
Fault coil	 1 flash YELLOW @100 ms every 1 s	<p>The coil did not energise properly.</p> <p><b>Solution:</b> the alarm is not blocking, so try operating the coil valve again. If the problem persists, replace the coil valve.</p>
Interrupted coil	 2 flashes YELLOW @100 ms every 1 s	<p>The coil is interrupted or missing. This alarm may be blocking (if configured as such) and therefore the island must be restarted.</p> <p><b>Solution:</b> replace the coil valve.</p>
Overcurrent coil	 3 flashes YELLOW @100 ms every 1 s	<p>The current consumption of the coil is excessive and therefore the coil valve is automatically switched off.</p> <p><b>Solution:</b> replace the coil valve.</p>
Overheating coil	 3 flashes YELLOW @100 ms every 1 s	<p>The coil temperature is too high. This alarm may be blocking (if configured as such) and therefore the island must be restarted.</p> <p><b>Solution:</b> remove the ON control on the coil valve and allow the coil to cool down. If the problem persists, replace the coil valve.</p>
Overheating subbase	 5 flashes YELLOW @100 ms every 1	<p>The subbase electronics temperature is too high.</p> <p><b>Solution:</b> switch off the island and let the device cool down. If the problem persists, contact support, and replace the subbase.</p>

**NOTE.** The interrupted coil and overcurrent alarms can block operation (configurable feature) and can only be reset by restarting the entire system.

## 6.2 Digital Input Module

The digital input module allows 8 or 16 digital signals to be monitored. 2-wire or 3-wire digital sensors can be connected, with the option of powering the sensors directly through the module (24 V power supply).

After being connected to the CX4 module, the digital input module must be mapped from the island (par. 7.3). If the mapping procedure ends successfully, the digital input module waits to receive the configuration parameters from the CX4 module (maximum wait 1 minute). Upon receipt of these parameters, the module enters the normal operating state, and the digital inputs can be read. Otherwise, if the mapping procedure is not completed successfully, the module remains in an error state, deactivating any operational function.

There is a dedicated diagnostic LED for each input, although the LED of the first channel is used for general diagnostics. (par. 6.2.5).

### 6.2.1 Features

The configuration parameters for the digital input modules make it possible to act on both the input reading logic and on the temporal characteristics of the signals read.

For signal logic, it is possible to choose the polarity of each channel, i.e. the activation mode: each channel can be active high or active low (*Activation Mode*). In the first case, the channel will assume a high logic state in the presence of input voltage and a low logic state in the absence of voltage; in the second case, the reverse will apply.

Regarding the temporal characteristics of the input signals, configuration does not take place on a channel-by-channel basis: the values associated with the parameters in question have an effect on all input channels of the module. In particular, it is possible to specify two parameters: the minimum activation time and the minimum input re-reading period. The first parameter (*Minimum Activation Time*) indicates the amplitude of the minimum time interval in which the input signal to a certain channel must maintain the same state in order for that channel to be associated with the corresponding logical state: the purpose of this procedure is to filter out signals with an unstable level (anti-bounce). The second parameter (*Extension Time*) takes over after the anti-bounce filter has accepted the input value and is described as follows.

- At time  $t_0$  there is a variation in the inputs not filtered by the anti-bounce system.
- At time  $t_1 > t_0$  there is a further variation. At this point, two conditions can occur:
  - $t_1 - t_0 \geq \textit{Extension Time}$ : the channel will assume the state determined by the value of the input signal at time  $t_1$ .
  - $t_1 - t_0 < \textit{Extension Time}$ : the channel is placed in a waiting state for re-reading: at time  $t_2 = t_0 + \textit{Extension Time}$ , the input is forcibly read and if the detected value differs from that acquired at time  $t_0$ , the channel assumes the new state, associated with the current signal value. If this is not the case (i.e. at time  $t_2$  the input value has returned to the same value as at time  $t_0$ ), the channel will not detect any change in the signal.

### 6.2.2 Connections and signals of the 8 digital input module (M8 version)

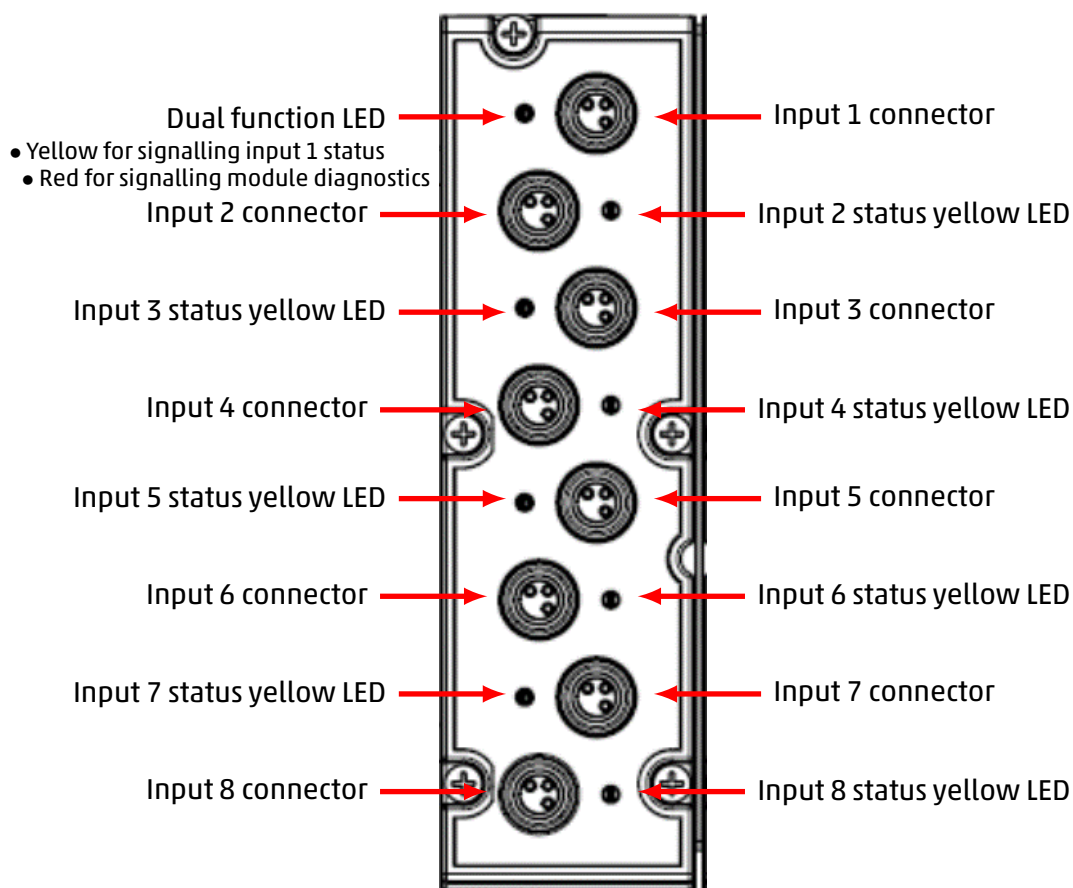

#### M8 connectors pinout

PIN	Signal	Description	Symbol
1	VCC	24 Vdc power supply for outside	
3	GND	GND reference	
4	Input	Input (max 100 mA for each input)	

**NOTE.** For the digital input modules, the M8 3-pole male connector for wiring is available in the Camozzi catalogue (cod. CS-DM03HB).

### 6.2.3 Connections and signals of the 8 digital input module (M12 version)

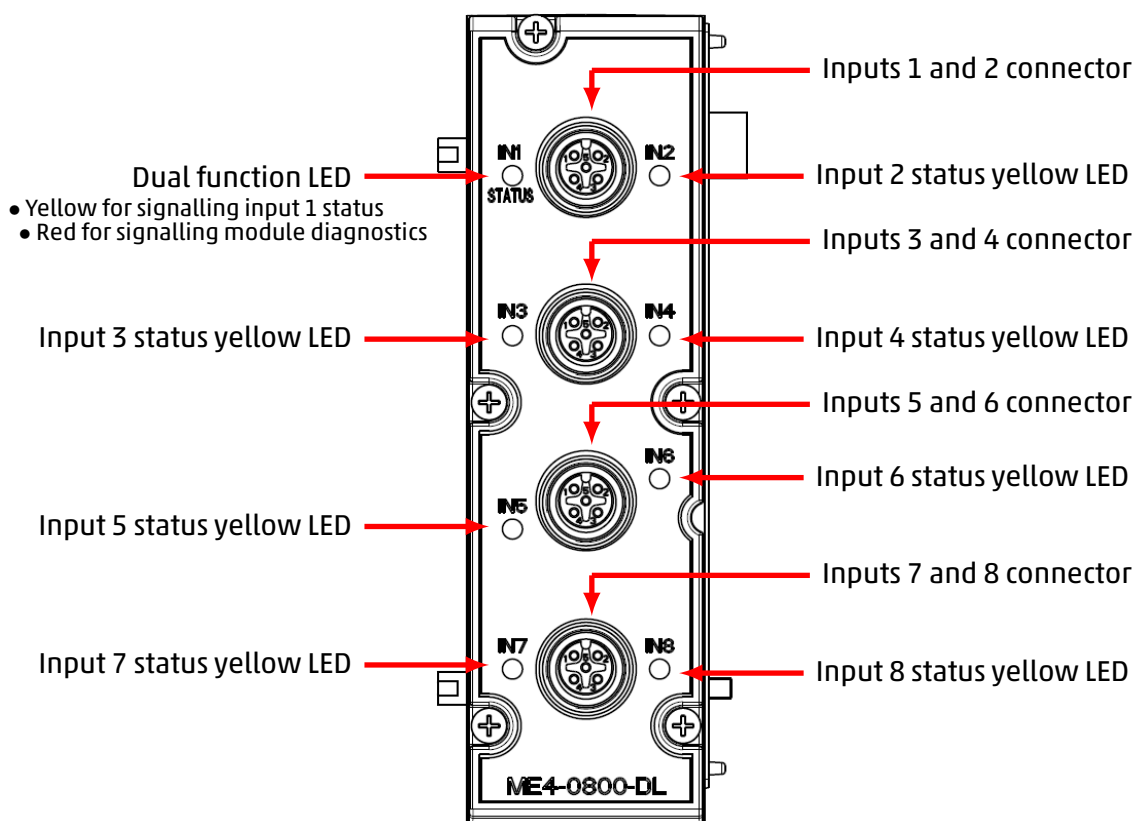

#### M12 connectors pinout

PIN	Signal	Description	Symbol
1	VCC	24 Vdc power supply for outside	
2	Input n+1	Input n+1 (max 100 mA for each input)	
3	GND	GND reference	
4	Input n	Input n (max 100 mA for each input)	
5	NC	Not connected	

**N.B.** The following connectors are available in the Camozzi catalog for digital input modules.

- Wired metal, straight, M12 A 5-pole male (cod. CS-LM05HC).
- Wired, straight, M12 A 5-pole male DOUBLE (cod. CS-LD05HF).

### 6.2.4 Connections and signals of the 16 digital input modules

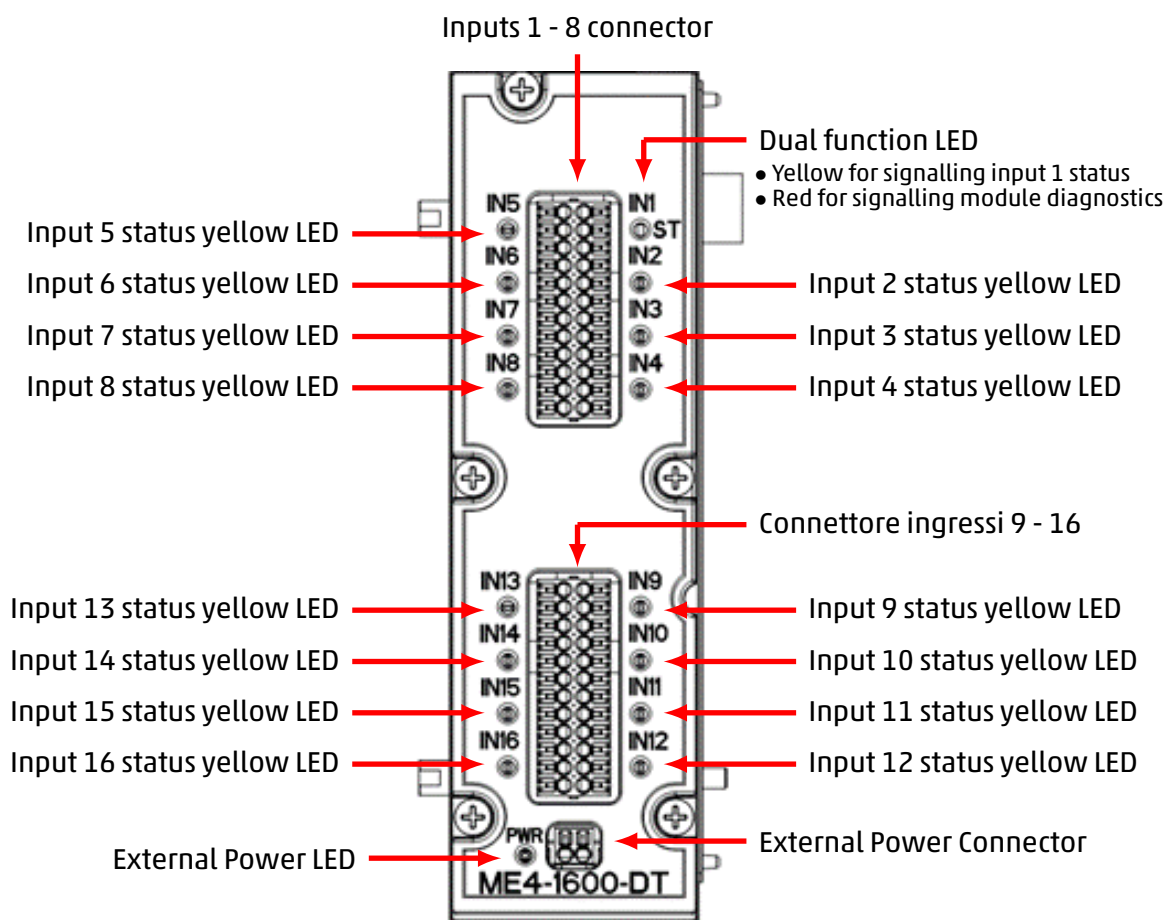

#### Input connectors pinout

The 16-channel connector is a RTB (DFMC and FMC series from Phoenix).

PIN	Signal	Description	Symbol
1, 4, 7, 10, 13, 16, 19, 22	VCC (+)	24 Vdc power supply for outside	
2, 5, 8, 11, 14, 17, 20, 23	Input n	Channel 1 input (max 50 mA for each input with internal power supply; 125 mA with external power supply)	
3, 6, 9, 12, 15, 18, 21, 24	GND (-)	GND reference	

**External power supply connector pinout**

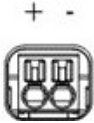
PIN	Signal	Description	Symbol
1	+	Input power supply 24Vdc	
2	-	GND reference	

**Connection mode**



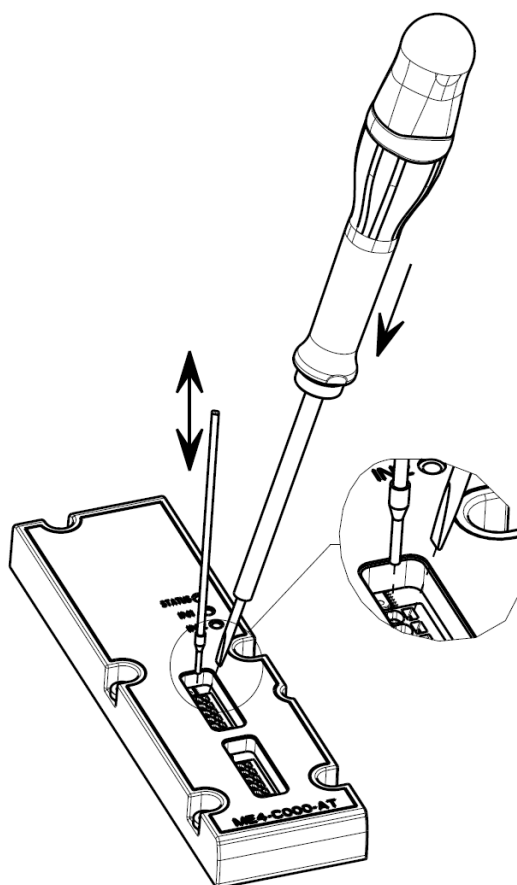

The cables must have a cross-section of 0.5mm<sup>2</sup> and a 0.4x2 screwdriver can be used to remove the terminal block from the module as per the datasheet.



## 6.2.5 Module diagnostics

### General diagnostic LED



The signalling LED of the first channel has the dual function of indicating the module diagnostics, as well as the activation status of the channel itself. When the module experiences certain conditions, the LED behaves as described in the following table.

Module status and alarms	LED status	Description of the status and solutions of the alarms
Start-up End mapping End configuration	 RED OFF	The module enters this state upon power-up and at the end of the mapping phase or the reception of configuration parameters.
Mapped module	 RED ON	The LED is lit during the mapping phase and is turned off if this procedure is completed successfully.
Waiting for configuration parameters	 1 flash RED @100 ms every 2 s	The module is waiting for configuration parameters (maximum duration 1 minute).
Communication alarm	 2 flashes RED @100 ms every 2 s	The alarm indicates that there is no communication between the digital input module and the CX4 module. <b>Solution:</b> try restarting the whole island and verifying that the physical connection to the digital input module is secure. If the problem persists, contact support, and replace the digital input module.
Short circuit digital inputs	 RED ON	At least one of the digital inputs is short-circuited. <b>Solution:</b> remove the input sensor and check the connection. If the problem persists, replace the sensor.



### Inputs status LED





When the module is in normal operating mode (fully operational and with no particular critical issues), the LED of the first channel behaves like the signalling LEDs of the remaining channels (from 2 to 16), i.e. it is lit and yellow when the input is active and off when the input is inactive.

Input status	LED status	Description
Input n inactive	 YELLOW OFF	The LED indicates that the corresponding digital input is not active.
Input n activated	 YELLOW ON	The LED indicates that the corresponding digital input has activated successfully.

### Diagnostic LED of the external power supply

In the 16-channel configuration, the digital input module is equipped with a connector for the external power supply with associated signalling LED.

**NOTE** The external power supply can be enabled or disabled through the configuration parameters from the controller/PLC or from UVIX.

External power status	LED status	Description of the status and solutions of the alarms
Not configured	 LED OFF	Power for the digital inputs is supplied directly from the digital input module.
External power supply present	 GREEN ON	External power is present, and the digital inputs are externally powered. For this mode, the parameter for using the external power supply must be configured correctly.
No external power supply	 RED ON	The module is configured to receive an additional external power supply, but this is not being detected by the module. <b>Solution:</b> check that the power is reaching the module correctly and that the connection has been made correctly.
Configured (External power supply out of range)	 1 flash RED @100 ms very 1 s	The module is configured to receive an additional external power supply, but this has a value of <21 Vdc or >27 Vdc. <b>Solution:</b> change the value of the power supply from the outside, bringing it within the proper operating range ( $21 \text{ Vdc} \leq V_{cc} \leq 27 \text{ Vdc}$ ).

## 6.3 Digital Output Module

The digital output module allows 8 or 16 digital signals to be provided outside the system. 2-wire or 3-wire digital actuators, type P or N, can be connected.

The digital output module, after being connected to the CX4 module, must be mapped by the island (par. 7.3). If the mapping procedure is completed successfully, the digital output module waits to receive the configuration parameters from the CX4 module (maximum wait 1 minute). Once these parameters have been received, the module enters the normal operational state, and the digital outputs can be activated. Otherwise, if the mapping procedure is not end successfully, the module remains in an error state, deactivating any operational functionality.

For each input there is a dedicated diagnostic LED, while for general diagnostics the LED of the first channel is used (par. 6.3.5).

### 6.3.1 Features

The configuration parameters of the digital output modules can be divided into several categories: activation mode, safety management with failsafe and PWM signal generation.

The parameters belonging to the first category consist of bit masks with different meanings.

- (*Module settings*): the value of this parameter is used to activate or deactivate individual functions related to the behaviour of the entire module (not the individual channels). Currently, only the least significant bit is set, which enables (1) or disables (0) the detection of no load by the power driver when a channel is activated. If detection is activated and at least one output is activated without the presence of a load, the module detects the fault, which is then signalled by a specific alarm.
- Channel enabling (*Enable output channels*): the single bits that make up the parameter value describe the enabling (1) or disabling (0) of individual output channels. If a non-enabled channel is activated during normal operation, the output driver does not supply voltage to the channel.
- Channel type setting (*Output channels mode*): each bit constituting the parameter value describes how the individual channels are activated. Each channel can be configured to supply type P (1) or type N (0) loads.

Below are the parameters involved in the second category: here too, the values represent bit masks with different meanings in each case.

- Enabling the failsafe (*Fail safe enable*): the bits that make up the parameter value describe whether the failsafe is enabled (1) or disabled (0) on the relevant channel. The purpose is to ensure that the outputs assume a certain state if a communication alarm occurs: in the presence of such a fault, the channels with failsafe enabled will assume the value prescribed by the failsafe status parameter, while those with failsafe disabled will maintain the state they had at the time the communication alarm occurred.
- Failsafe status (*Fail safe status*): the bit mask representing the value of this parameter describes the status of the channels for which failsafe is enabled, should a communication alarm occur. In particular: 1 indicates that the corresponding channel should be activated, 0 that the corresponding channel should be deactivated.

Finally, the following are the parameters describing the operation of the output module as a PWM signal

generator.

- PWM channel type setting (*Pwm channels*): the value of this parameter represents a bit mask indicating the mode of operation of individual channels. In particular: 1 indicates that the relevant channel should generate a PWM signal when activated, 0 indicates that the channel must instead operate in ON/OFF mode and therefore should generate a continuous signal when activated.
- PWM activation time (*Pwm activation time*): indicates the activation time for channels configured as PWM, in milliseconds (from 0 to 255). In particular, when a PWM channel is activated, it immediately assumes a duty cycle equal to 100% and maintains it until the specified time has elapsed: from that moment on, the PWM signal will be modulated with a duty cycle equal to the value of the Duty cycle per channel parameter (see below). The parameter has an effect on all of the module's channels.
- Duty cycle per channel (*Pwm channels duty cycle*): the value of this parameter describes the duty cycle to be applied to the individual PWM channels when they are activated, after the activation time has elapsed. It is expressed as a percentage (from 0 to 100) and is associated with the individual channel.

### 6.3.2 Connections and signals of the 8 digital output modules (M8 version)

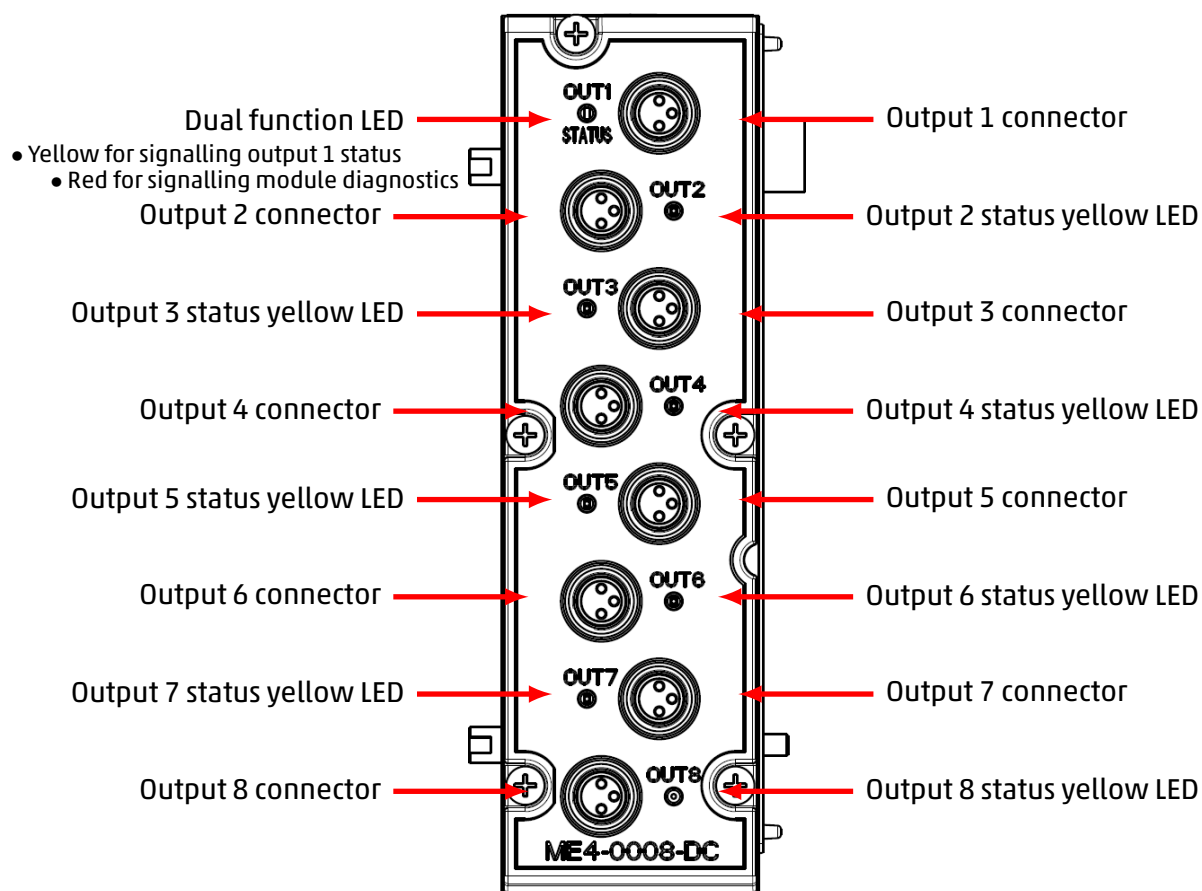

#### M8 connectors pinout

PIN	Signal	Description	Symbol
1	VCC	24 Vdc power supply for outside	
3	GND	GND reference	
4	Output	Output (max 125 mA for each output)	

**NOTE.** For the digital output modules, the M8 3-pole male connector for wiring is available in the Camozzi catalogue (cod. CS-DM03HB).

### 6.3.3 Connections and signals of the 8 digital output modules (M12 version)

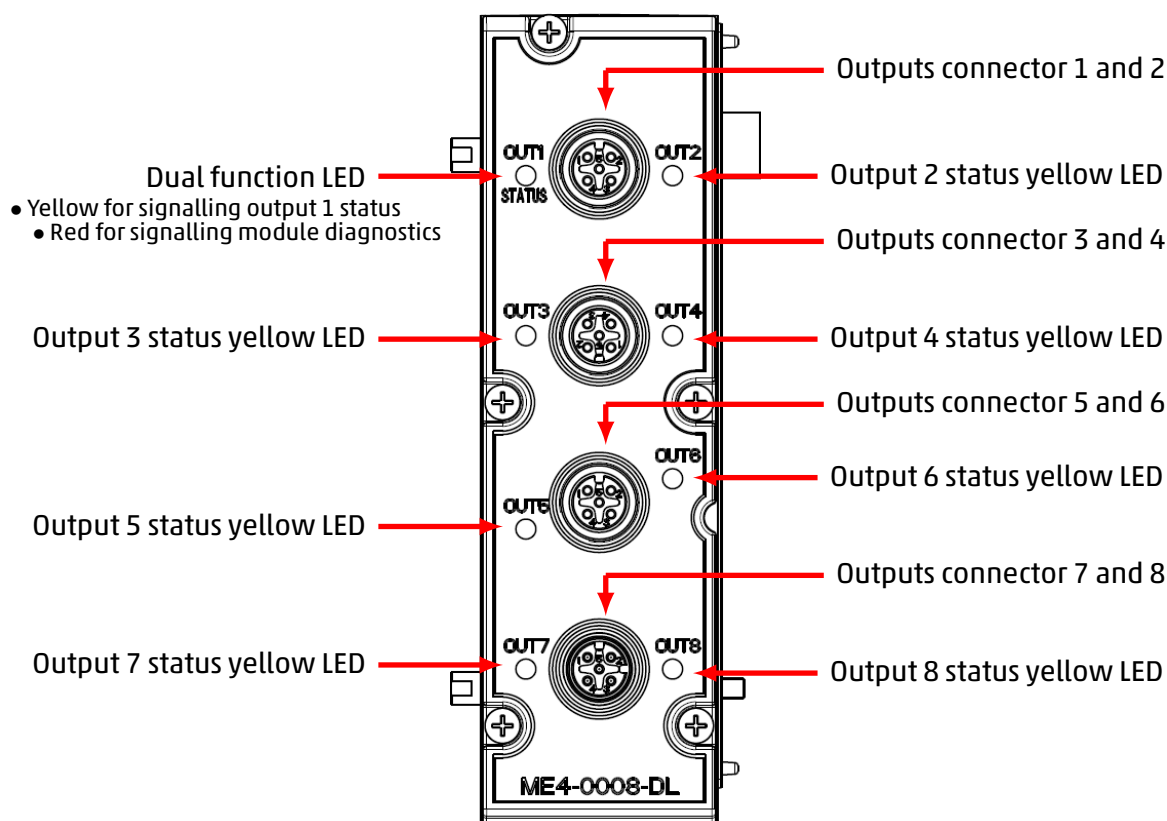

#### M12 connectors pinout

PIN	Signal	Description	Symbol
1	VCC	24 Vdc power supply for outside	
2	Output n+1	Output n+1 (max 125 mA for each output)	
3	GND	GND reference	
4	Output n	Output n (max 125 mA for each output)	
5	NC	Not connected	

**N.B.** The following connectors are available in Camozzi’s catalog for digital output modules.

- Wired metal, straight, M12 A 5-pole male (cod. CS-LM05HC).
- Wired, straight, M12 A 5-pole male DOUBLE (cod. CS-LD05HF).

### 6.3.4 Connections and signals of the 16 digital output modules

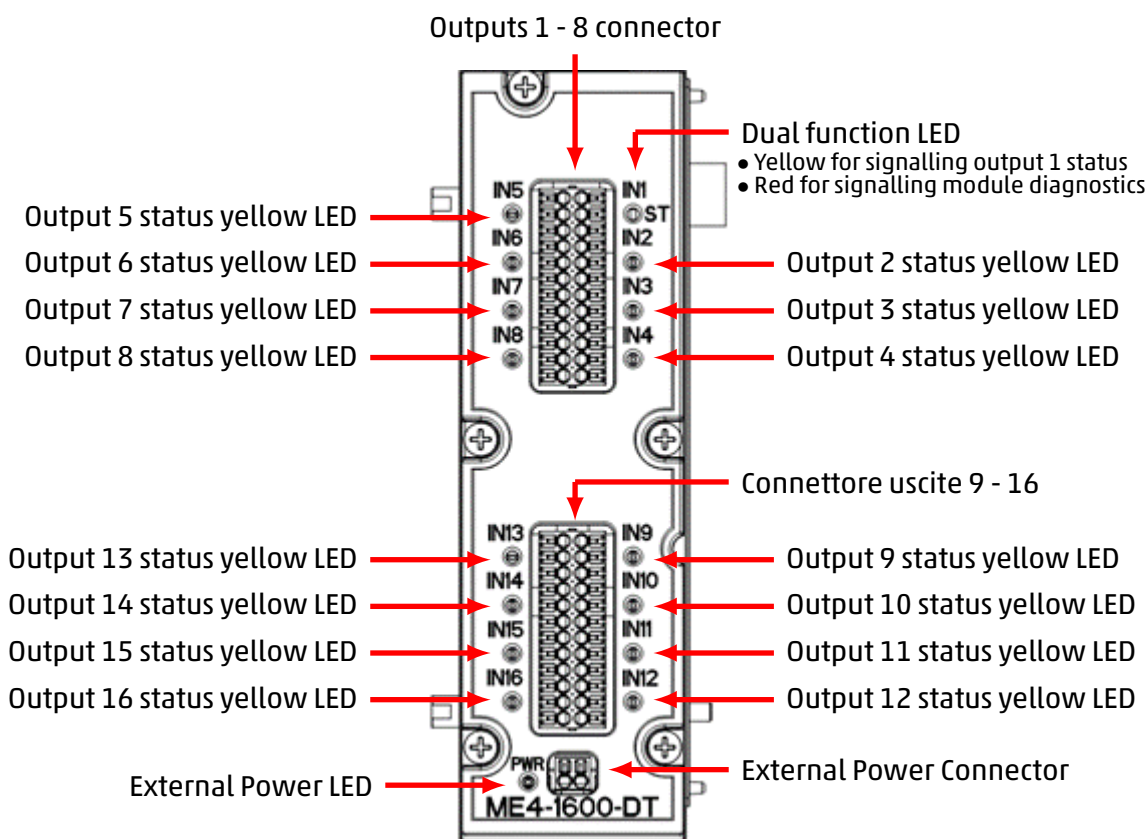

#### Output connectors pinout

The 16-channel connector is a RTB (DFMC and FMC series from Phoenix). The cables must have a cross-section of 0.5 mm<sup>2</sup> and a 0.4x2 screwdriver can be used to remove the terminal block from the module as per the datasheet.

PIN	Signal	Description	Symbol
1, 4, 7, 10, 13, 16, 19, 22	VCC (+)	24 Vdc power supply for outside	
2, 5, 8, 11, 14, 17, 20, 23	Output n	Output n (max 125 mA for each output)	
3, 6, 9, 12, 15, 18, 21, 24	GND (-)	GND reference	

**External power supply connector pinout**

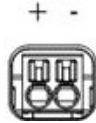
PIN	Signal	Description	Symbol
1	+	Input supply voltage 12÷32 Vdc	
2	-	GND reference	

**NOTE.** The 16-channel digital output module must be externally powered.

**Connection mode**

The cables must have a cross-section of 0.5mm<sup>2</sup> and a 0.4x2 screwdriver can be used to remove the terminal block from the module as per the datasheet.

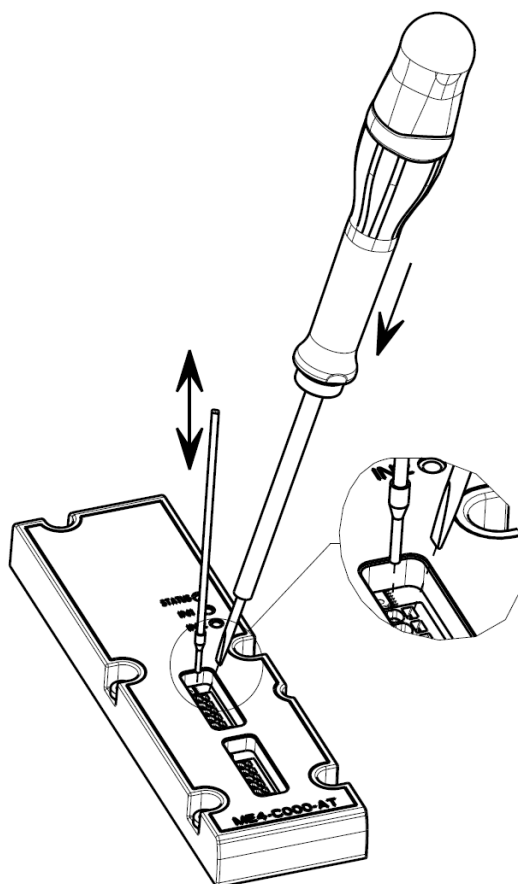











### 6.3.5 Module diagnostics

#### General diagnostic LED



The signalling LED of the first channel has the dual function of indicating the module diagnostics, as well as the activation status of the channel itself. When the module experiences certain conditions, the LED behaves as described in the following table.

Module status and alarms	LED status	Description of the status and solutions of the alarms
Start-up End of the mapping End of the configuration phase	 RED OFF	The module enters this state when it is switched on, at the end of the mapping phase and when the configuration parameters are received.
Mapped module	 RED ON	The LED is lit during the mapping phase and is switched off if this procedure is completed successfully.
Waiting for configuration parameters	 1 flash RED @100 ms every 2 s	The module is waiting for configuration parameters (maximum duration 1 minute).
Short circuit on digital output channels	 RED ON	At least one of the digital outputs is short-circuited. <b>Solution:</b> check the connection and, if necessary, remove the output load and replace it.
Open circuit on digital output channels	 3 flashes RED @100 ms every 2 s	At least one output is not connected to the load and the open circuit is detected. <b>Solution:</b> check the load connection with the output connector.

Module status and alarms	LED status	Description of the status and solutions of the alarms
<p>Undervoltage voltage supply (For 16-channel modules only)</p>	 4 flashes RED @100 ms every 2 s	<p>The supply voltage is less than 4.5 V.  <b>Solution:</b> change the power supply value and return to the correct operating range (Vcc = 24 V).</p>
<p>No voltage supply (For 16-channel modules only)</p>	 4 flashes RED @100 ms every 2 s	<p>Circuit power is missing or shorted.  <b>Solution:</b> check that the power reaches the module correctly and that the connection has been made correctly.</p>
<p>Communication alarm</p>	 2 flashes RED @100 ms every 2 s	<p>No response from the CX4 to output status and diagnostic signalling.  <b>Solution:</b> contact support and replace the digital output module cover.</p>

### Outputs status LED



When the module is in normal operating mode (fully operational and with no particular critical issues), this LED behaves like the signalling LEDs of the remaining channels (from 2 to 16), i.e. it is lit and yellow when the output is active and off when the output is inactive.

Output status	LED status	Description
Output n inactive	 YELLOW OFF	The LED indicates that the corresponding digital output is not active.
Output n activated	 YELLOW ON	The LED indicates that the corresponding digital output has activated successfully.

### Diagnostic LED of the external power supply

In the 16-channel configuration, the digital output module is equipped with a connector for the external power supply with associated signalling LED.

**NOTE.** It is mandatory for the external power supply to be connected.

External power status	LED status	Description of the status and solutions of the alarms
External power supply ok	 GREEN OFF	The module is correctly receiving the additional external power supply.
No external power supply	 GREEN OFF	The module does not detect the additional power supply and therefore cannot work. <b>Solution:</b> verify that power is reaching the module properly. If the problem persists, contact support, and replace the module.

## 6.4 Analogue Input Module

The analogue input module can monitor two analogue sensors simultaneously. The types of sensors that can be connected are:

- Resistance thermometers (RTD) for temperature measurement.
- Thermocouples for temperature measurement.
- Bridge for resistance measurement.
- Generic sensors with voltage or current outputs.

The analogue input module, after being connected to the CX4 module, must be mapped from the island (par. 7.3). If the mapping procedure is completed successfully, the module waits to receive the configuration parameters from the CX4 module. Upon receipt of these parameters, the module enters the normal operating state, and the analogue inputs can be read out. Otherwise, if the mapping procedure is not completed successfully, the module remains in an error state, deactivating any operational function.

### 6.4.1 Data format

Each channel restores the conversion of the corresponding input into a 16-bit or 32-bit word. The datum is represented in 2's complement and, depending on the module, corresponds to different values.

Module	Word transmitted	Data format	Size
RTD	16 bits	16 bits 2's complement	°C/10
THERMOCOUPLES	16 bits	16 bits 2's complement	°C/10
BRIDGE	32 bits	24 bits 2's complement	uV
VOLTAGE/CURRENT	16 bits	16 bits 2's complement 16 bits RAW (6.4.8)	mV, uA RAW

Each channel is also associated with a diagnostics byte which reports the errors indicated in the diagnostic. In case of correct operation, the diagnostics byte is equal to 0. Otherwise, it is possible to analyse the error by referring to the paragraph on the field bus.

If the diagnostics byte is different from 0, the bridge module will send data equal to 0x7FFFFF while all the others will transmit the value 0x7FFF (**NOTE.** this is not applied in case of RAW data format).

The data format used by the CX4 for communication with the PLC is of the *little endian* type for the PROFINET/IO protocol.

### Example

In the little endian format, the least significant byte (LSB) is sent first. For example, the value 100000 uV (0x186A0) received from a BRIDGE module will be sent as follows:

	LSB	MID	MSB
Address	0x00	0x01	0x02
Data	0xA0	0x86	0x01

### 6.4.2 Features

The configurable parameters are the type of inputs, the transmission parameters and the filters to be applied to the inputs.

#### Inputs configuration

Each input must be appropriately configured, depending on the type of module used. For example, in the case of an RTD module, we could decide to have the following configuration:

- Channel 1: 4-wire PT100
- Channel 2: 2-wire PT1000

Or, for a Thermocouple module, the following configuration may be required:

- Channel 1: Type K thermocouple
- Channel 2: disabled

For a detailed description of the input configuration for the different analogue inputs, refer to the following paragraphs.

#### Transmission parameters configuration:

The modules can transmit data to the head in two different ways: in frequency and threshold.

When the transmission is configured in frequency (*Sampling Threshold* and *Sampling Threshold Timeout* parameters disabled), it is possible to set a transmission frequency (*Sampling Rate*) with which the module regularly transmits the acquired data to the head. **NOTE.** This parameter has nothing to do with the sampling frequency of the module inputs, which is fixed. To find out this frequency, refer to the Technical Data tables in this manual (par. 6.4).

When the transmission is configured as threshold (*Sampling Threshold* parameter other than zero), the module transmits the data to the head only if the current value is higher than the previous value of that set as threshold. If the input does not undergo changes beyond the threshold, the module still transmits the data when the timeout expires (*Sampling Threshold Timeout*). In the case of threshold operation, the *Sampling Frequency* parameter can be used to impose a limit on the frequency variation of the signal with respect to the threshold. In this way it is possible to reduce the shared bus occupation by the modules.

### Example

Let's consider an RTD module with both channels enabled and with the following transmission configuration:

- Sampling Frequency: 5 Hz
- Sampling Threshold: disabled
- Sampling Threshold Timeout: disabled

the module sends the data acquired by the inputs and the related diagnostics to the PLC every 200 milliseconds.

If the configuration were instead:

- Sampling Frequency: 1 Hz
- Sampling Threshold: 0.2 °C
- Sampling Threshold Timeout: 5 seconds

The module transmits the data acquired by the inputs and the related diagnostics to the PLC in the following cases:

- If the temperature measurement at the current time of either input exceeds the previous one by at least 0.2° C.
- If there is no temperature variation beyond the threshold for more than 5 seconds.

In the first case, if the temperature variation frequency with respect to the threshold were higher than 1 Hz, the transmission would be limited to 1 Hz.

---

### Filter configuration:

Each input is equipped with a digital moving average filter. The maximum length of the filter impulse response is 128 samples. In the default configuration the filters are disabled.

### 6.4.3 Connections and signals of the modules



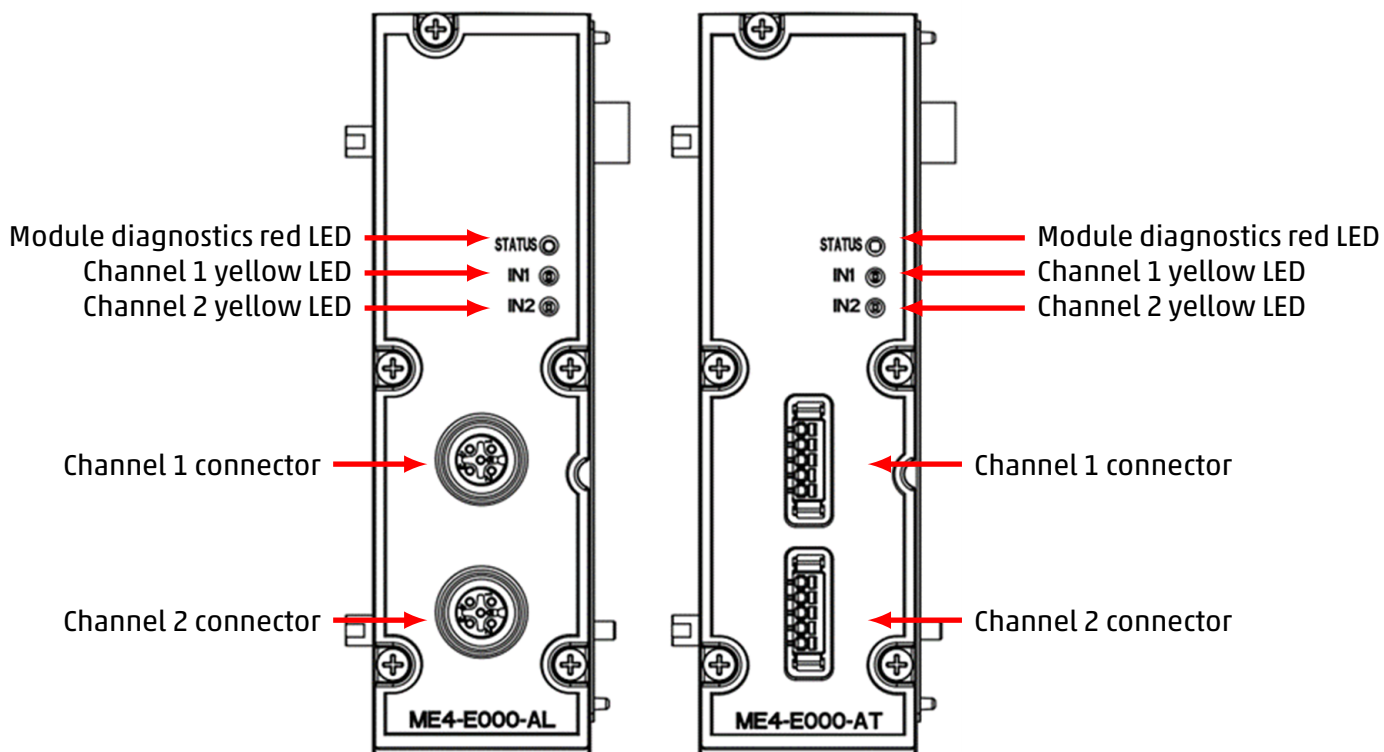









The analogue modules can have two types of connectors for connections with sensors. In the following figure, the left side shows an analogue module with 5-pole coded M12 A female connectors, while the right side shows an analogue module with 5-pole female TB connectors.











**NOTE.** The different types of analogue input modules have specific pinouts dedicated to their functionality. Visual indication of operation and diagnostics is via three LEDs.







### 6.4.4 Module diagnostics

**NOTE.** For a detailed description of the sensor faults, refer to the specific paragraphs of each module (RTD, thermocouples, bridge, and V/C modules).

Module status and alarms	LED STATUS	LED IN1	LED IN2	Description of the status and solutions of the alarms
Waiting for configuration parameters	 1 flash RED @100 ms every 2 s	 YELLOW OFF	 YELLOW OFF	The module is waiting for configuration parameters (maximum duration 1 minute).
Sensor working on channel 1	 RED OFF	 YELLOW ON	 YELLOW OFF	The sensor connected to channel 1 is functioning correctly.
Sensor working on channel 2	 RED OFF	 YELLOW OFF	 YELLOW ON	The sensor connected to channel 2 is functioning correctly.
Sensor alarm on channel 1	 2 flashes RED @100 ms every 2 s	 2 flashes YELLOW @100 ms every 2 s	 YELLOW OFF	Sensor fault enabled and connected on channel 1. <b>Solution:</b> check the correct connection of the sensor and its power supply.



Module status and alarms	LED STATUS	LED IN1	LED IN2	Description of the status and solutions of the alarms
Bridge sensor missing on channel 1 (Blocking alarm only for bridge type module)	 3 flashes RED @100 ms every 2 s	 3 flashes YELLOW @100 ms every 2 s	 YELLOW OFF	Bridge sensor missing or faulty when configuring the module on channel 1. <b>Solution:</b> sensor connections and restart the module.
Sensor alarm on channel 2	 2 flashes RED @100 ms every 2 s	 YELLOW OFF	 2 flashes YELLOW @100 ms every 2 s	Sensor fault enabled and connected on channel 2. <b>Solution:</b> check that the sensor and its power supply are connected correctly.
Bridge sensor missing on channel 2 (Blocking alarm only for bridge type module)	 3 flashes RED @100 ms every 2 s	 YELLOW OFF	 3 flashes YELLOW @100 ms every 2 s	Bridge sensor missing or faulty when configuring the module on channel 2. <b>Solution:</b> check sensor connections and restart the module..

Module status and alarms	LED STATUS	LED IN1	LED IN2	Description of the status and solutions of the alarms
<p>ADC communication error</p>	 4 flashes RED @100 ms every 2 s	 YELLOW OFF	 YELLOW OFF	<p>It occurs in the event of communication problems between the microcontroller and the ADC that measures the physical input quantity.  <b>Solution:</b> contact support and replace the module.</p>
<p>Reference voltage 3.3 V error</p>	 RED ON	 YELLOW OFF	 YELLOW OFF	<p>Occurs when there is a problem with the logic voltage (3.3 V).  <b>Solution:</b> contact support and replace the module.</p>

**6.4.5 RTD Module (Resistance Temperature Detector)**

Resistance temperature detectors (RTDs) can be connected to these analogue modules for temperature measurement. It is possible to configure some parameters individually to take the measurements.



**Dati tecnici**

Key feature	Value																													
Sensor types	<table border="1"> <thead> <tr> <th rowspan="2" style="text-align: center;">Type</th> <th colspan="2" style="text-align: center;">Temperature [°C]</th> </tr> <tr> <th style="text-align: center;">Minimum</th> <th style="text-align: center;">Maximum</th> </tr> </thead> <tbody> <tr> <td>PT100 (385)</td> <td style="text-align: center;">-200</td> <td style="text-align: center;">850</td> </tr> <tr> <td>PT100 (3926)</td> <td style="text-align: center;">-200</td> <td style="text-align: center;">630</td> </tr> <tr> <td>PT200 (385)</td> <td style="text-align: center;">-200</td> <td style="text-align: center;">850</td> </tr> <tr> <td>PT500 (385)</td> <td style="text-align: center;">-200</td> <td style="text-align: center;">850</td> </tr> <tr> <td>PT1000 (385)</td> <td style="text-align: center;">-200</td> <td style="text-align: center;">850</td> </tr> <tr> <td>Ni100 (618)</td> <td style="text-align: center;">-60</td> <td style="text-align: center;">180</td> </tr> <tr> <td>Ni120 (672)</td> <td style="text-align: center;">-80</td> <td style="text-align: center;">260</td> </tr> <tr> <td>Ni1000 (618)</td> <td style="text-align: center;">-60</td> <td style="text-align: center;">250</td> </tr> </tbody> </table>	Type	Temperature [°C]		Minimum	Maximum	PT100 (385)	-200	850	PT100 (3926)	-200	630	PT200 (385)	-200	850	PT500 (385)	-200	850	PT1000 (385)	-200	850	Ni100 (618)	-60	180	Ni120 (672)	-80	260	Ni1000 (618)	-60	250
Type	Temperature [°C]																													
	Minimum	Maximum																												
PT100 (385)	-200	850																												
PT100 (3926)	-200	630																												
PT200 (385)	-200	850																												
PT500 (385)	-200	850																												
PT1000 (385)	-200	850																												
Ni100 (618)	-60	180																												
Ni120 (672)	-80	260																												
Ni1000 (618)	-60	250																												
Type of connections	2/3/4 wires																													
Number of inputs	2																													
Sensor connections	M12 A-coded 5 pole female connectors for each input TB 5 pole female connectors for each input																													
Converter resolution	16 bit																													
Reading resolution	0.1 °C																													
Measurement error	< ±1 °C																													
Sampling frequency	4 Hz for each input																													
Digital filter	Moving average filter (configurable up to 128 samples) for each input																													
Signalling and diagnostics	Board diagnostics red LED Yellow LED for each input																													

### Electrical connections

The RTD wiring diagram is different depending on the number of wires used:

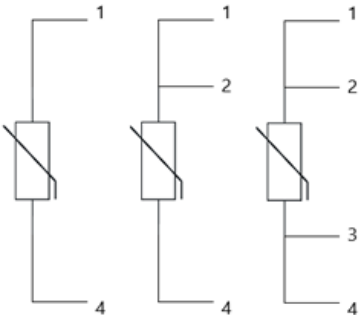
- 2-wire RTDs must be connected between pin 1 and pin 4 of the connector.
- 3-wire RTDs must be connected between pin 2 and pin 4 of the connector, compensation wire to pin 1.
- 4-wire RTDs must be connected between pin 2 and pin 3 of the connector, compensation wires to pin 1 and 4.

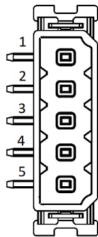
Possible types of connections (2/3/4 fili)	M12A connector	TB connector
		

### Faults

The module is able to detect the following faults:

- RTD sensor disconnected or broken.
- Sensor temperature range exceeded by more than  $\pm 1^\circ \text{C}$ .

**NOTE.** Detection of compensation wire disconnection (A4- input for 3-wire RTD, A1 + and/or A4 + inputs for 4-wire RTD) can take several seconds.

**6.4.6 Thermocouple module**

Thermocouples can be connected to these analogue modules for temperature measurement. It is possible to configure some parameters individually to take the measurements.

**Technical Data**

Key feature	Value																													
Sensor types	<table border="1"> <thead> <tr> <th rowspan="2">Type</th> <th colspan="2">Temperature [°C]</th> </tr> <tr> <th>Minimum</th> <th>Maximum</th> </tr> </thead> <tbody> <tr> <td>B</td> <td>250</td> <td>1820</td> </tr> <tr> <td>E</td> <td>-200</td> <td>1000</td> </tr> <tr> <td>J</td> <td>-210</td> <td>1200</td> </tr> <tr> <td>K</td> <td>-200</td> <td>1372</td> </tr> <tr> <td>N</td> <td>-200</td> <td>1300</td> </tr> <tr> <td>R</td> <td>-50</td> <td>1768.1</td> </tr> <tr> <td>S</td> <td>-50</td> <td>1768.1</td> </tr> <tr> <td>T</td> <td>-200</td> <td>400</td> </tr> </tbody> </table>	Type	Temperature [°C]		Minimum	Maximum	B	250	1820	E	-200	1000	J	-210	1200	K	-200	1372	N	-200	1300	R	-50	1768.1	S	-50	1768.1	T	-200	400
Type	Temperature [°C]																													
	Minimum	Maximum																												
B	250	1820																												
E	-200	1000																												
J	-210	1200																												
K	-200	1372																												
N	-200	1300																												
R	-50	1768.1																												
S	-50	1768.1																												
T	-200	400																												
Number of inputs	2																													
Sensor connections	M12 A-coded 5 pole female connectors for each input TB 5 pole female connectors for each input																													
Converter resolution	16 bit																													
Reading resolution	0.1 °C																													
Measurement error	< < ±2°C for thermocouples E, J, K, N, T < ±4°C for thermocouples B, R, S																													
Sampling frequency	4 Hz for each input																													
Digital filter	Moving average filter for each input (configurable up to 128 samples)																													
Signalling and diagnostics	Board diagnostics red LED Yellow LED for each input																													

### Electrical connections

The thermocouple must be connected to pins 2 (positive) and 4 (negative) of the M12 or TB connector. Between pins 1 and 3 there is an RTD (PT100) on the circuit, which is needed to perform CJC (Cold Junction Compensation) fully automatically.

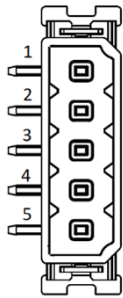
Pin	Signal	Description	M12A connector	TB connector
1	CJC	PT100 for cold junction compensation (do not connect)		
2	TC+	Thermocouple positive input		
3	CJC	PT100 for cold junction compensation (do not connect)		
4	TC-	Thermocouple negative input		
5	GND	Earth		

### Faults

The module is able to detect the following faults:

- Thermocouples sensor disconnected or broken.
- Sensor temperature range exceeded by more than  $\pm 2^{\circ}\text{C}$ .

**NOTE.** Detection of thermocouple sensor disconnection may take several seconds.

**6.4.7 Bridge module**

Bridge modules are based on resistive bridge operation with variable sensitivity (e.g. load cells).

**Technical Data**

Key feature	Value
Sensor types	4-wire resistor bridges (e.g. load cells) with variable bridge factor (sensitivity) are supported: from 2 mV/V to 255 mV/V at intervals of 1 mV/V
Number of inputs	2
Sensor connections	M12 A-coded 5 pole female connectors for each input TB 5 pole female connectors for each input
Converter resolution	24 bits
Reading resolution	1 $\mu$ V
Measurement error	Dependent on the bridge factor
Sampling frequency	1 kHz for each input
Bridge excitation voltage	5 V
Digital filter	Moving average filter (configurable up to 128 samples) for each input
Signalling and diagnostics	Board diagnostics red LED Yellow LED for each input

### Electrical connections

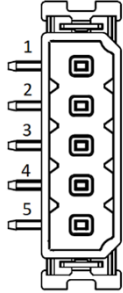
Pin	Signal	Description	M12A connector	TB connector
1	ECC1+	Positive excitation voltage of the resistor bridge (+ 5V)		
2	ECC1-	Negative excitation voltage of the resistor bridge (0V)		
3	SRB1+	Positive differential signal of the resistor bridge		
4	SRB1-	Negative differential signal of the resistor bridge		
5	GND	Earth		

### Load cells

The load cells can be connected to the Bridge module to measure a force applied to an object by reading the voltage made by the resistor bridge. The voltage to weight conversion formula for load cells is as follows:

$$F = \frac{F_N \cdot U}{C \cdot U_{EXC}}$$

Dove:

- F is the force detected by the load cell (Kg)
- $F_N$  is the capacity of the load cell (Kg)
- C is the sensitivity of the load cell (mV/V)
- $U_{EXC}$  is the excitation voltage of the resistor bridge, this value is fixed and equal to 5V
- U is the voltage read by the load cell

### Example

A load cell has the following characteristics:  $C = 2 \text{ mV/V}$  e  $F_N = 5 \text{ Kg}$ . Following the application of a force on the load cell, the module detects a voltage of 100  $\mu\text{V}$ . Obtain the corresponding weight value:

$$F = \frac{5\text{Kg} \cdot 0.1\text{mV}}{2\text{mV/V} \cdot 5\text{V}} = 0.05\text{Kg}$$

Therefore, the weight value read corresponds to 50 grams.



### Measurement error

The AD converter on the module includes a PGA (Programmable Gain Amplifier) whose gain is optimised according to the bridge factor set. This gain determines the full scale of the measurement and the related noise. The following table shows the full-scale errors for the most common bridge factors.

Bridge factor (mV/V)	Full scale (mV)	Error % (referring to full scale)
< 8	78,1	±0,0243
16	156,3	±0,0128
32	312,5	±0,0067
64	625,0	±0,0062
128	1250,0	±0,0056
256	2500,0	±0,0064

### Faults

The module is able to detect the following faults:

- Short circuit between ECC + and ECC- pin (excitation voltage).
- Resistor bridge disconnected.
- Exceeding the full-scale value of the resistor bridge ( $U_{EXC}$ ) of 1%.

**NOTE.** The disconnection of the *resistor bridge* can only be detected at the moment the module is configured and not while in operating mode. The error remains set until a *resistor bridge* is inserted and a subsequent reconfiguration is performed.

**6.4.8 Voltage/Current module**

The voltage/current (V/C) modules are analogue input modules that allow both analogue current and voltage measurements.

**Technical Data**

Key feature	Value
Sensor types	The following voltage and current inputs are supported: 0÷10 V 0÷10 V RAW ±10 V 4÷20 mA 4÷20 mA RAW 0÷20 mA ±20 mA
Number of inputs	2
Sensor connections	M12 A-coded 5 pole female connectors for each input TB 5 pole female connectors for each input
Converter resolution	16 bit
Reading resolution	1 mV 160.2 $\mu$ V RAW 1 $\mu$ A 259.4 nA RAW
Measurement error	< $\pm$ 0.3% (relative to the full scale $\pm$ 10 V) < $\pm$ 0.3% (relative to the full-scale 0÷20mA)
Sampling frequency	100 Hz for each input
Bridge excitation voltage	5 V
Digital filter	Moving average filter (configurable up to 128 samples) for each input
Signalling and diagnostics	Board diagnostics red LED Yellow LED for each input

### Electrical connections

Pin	Signal	Description	M12A connector	TB connector
1	+24EX	24 Vdc auxiliary voltage		
2	IN+	Positive voltage or current signal differential input		
3	GND	Earth		
4	IN-	Negative voltage or current signal differential input		
5	GND	Earth		

**NOTE.** Maximum absorption value: 200 mA per channel or 400 mA if there is only one sensor powered by the board.

#### Data range

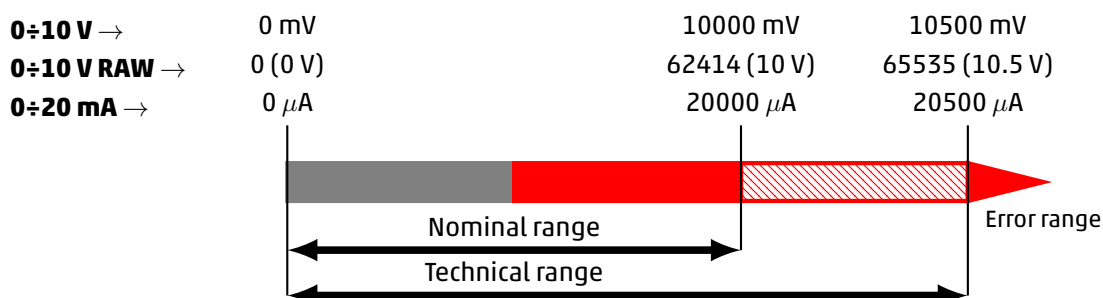
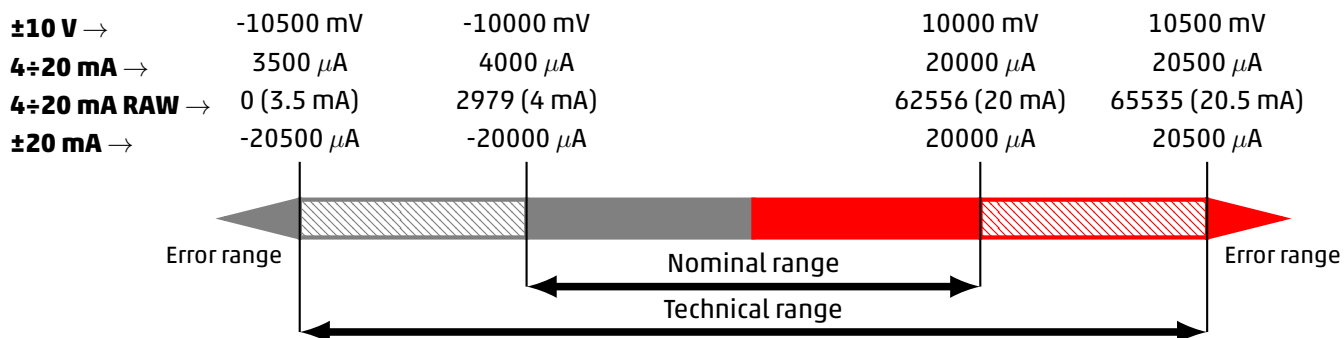

### Formato RAW

The 0÷10 V RAW and 4÷20 mA RAW configurations return a RAW value that must be converted in order to obtain the correspondent voltage or current value. In this case the measurement range is linearly mapped in a 16 bit number and it is considered the technical range.

$$0\div 10 \text{ V RAW} \rightarrow V(V) = \frac{10.5V}{65535} \cdot RAW_{VAL}$$

$$4\div 20 \text{ mA RAW} \rightarrow I(mA) = \frac{17mA}{65535} \cdot RAW_{VAL} + 3.5mA$$

### Faults

The module is able to detect the following faults:

- Minimum and maximum voltage/current exceeded by  $\pm 60\text{mV}$  or  $\pm 60\mu\text{A}$ .
- 5 Open circuit (if channel configured with voltage).

**NOTE.** Open circuit detection (voltage configured channel) can take several seconds.

## 6.5 Analogue Output Module

The analogue output module can control two independent outputs with the following configurations:

- 0÷10 V voltage
- 0÷5 V voltage
- 0÷20 mA current
- 4÷20 mA currente

The analogue output module, after being connected to the CX4 module, must be mapped from the island (par. 7.3). If the mapping procedure ends correctly, the module waits for the reception of the configuration parameters from the CX4 module. Once these parameters have been received, the module enters normal operating status and the outputs, if enabled, can be set. Otherwise, if the mapping procedure does not finish correctly, the module remains in an error state by disabling any operational functionality.

### Technical Data

Key feature	Value
Sensor types	0÷10 V 0÷5 V 0÷20 mA 4÷20 mA
Number of outputs	2
Sensor connections	M12 A-coded 5 pole female connectors for each input TB 5 pole female connectors for each input
Converter resolution	16 bit
Reading resolution	1 mV 1 $\mu$ A
Measurement error	
Signalling and diagnostics	Board diagnostics red LED Yellow LED for each input

### 6.5.1 Data format

Each channel restores the conversion of the corresponding input into a 16-bits.

Module	Word transmitted	Data format	Size
VOLTAGE/CURRENT	16 bits	16 bits, 2's complement	mV, uA

The data format used by the CX4 for communication with the PLC is of the *little endian* type for the PROFINET/IO protocol.

#### Example

In the little endian format, the least significant byte (LSB) is sent first. For example, the value 5000 mV (0x1388) received from a V/C module will be sent as follows:

	LSB	MSB
Data	0x88	0x13

### 6.5.2 Features

The configurable parameters are the type of outputs and the safety management with failsafe. In fact, each output must be suitably configured as a voltage or current channel. In case of loss of communication with the PLC, it is also possible to assign default values, both in voltage and in current, to the analogue outputs (failsafe). In particular, for each channel you can:

- assign the value it had before the communication failure (failsafe disabled).
- Assign a desired value, configurable in the master configuration tool (failsafe enabled).

#### Example

Considering an analogue outputs module with both channels enabled in voltage and failsafe enabled only on the second channel. In this case, the parameters configuration is as follows:

- Channel Configuration Channel 1: 1 (0÷10 V)
- Channel Configuration Channel 2: 2 (0÷5 V)
- Fail Safe Enable Channel 1: 0
- Fail Safe Enable Channel 2: 1
- Fail Safe Value Channel 1: 0
- Fail Safe Value Channel 2: 3500

In case of loss of communication with the PLC, the value of channel 1 is equal to the last data received from the PLC before the failure, while on channel 2 the value of 3500 mV is set as a consequence of enabling the failsafe and setting the failsafe value.

### 6.5.3 Connections and signals of the modules

The analogue modules can have two types of connectors for connections with sensors. In the following figure, the left side shows an analogue module with 5-pole coded M12 A female connectors, while the right side shows an analogue module with 5-pole female TB connectors. The different types of analogue output modules have specific pinouts dedicated to their functionality. Visual indication of operation and diagnostics is via three LEDs.

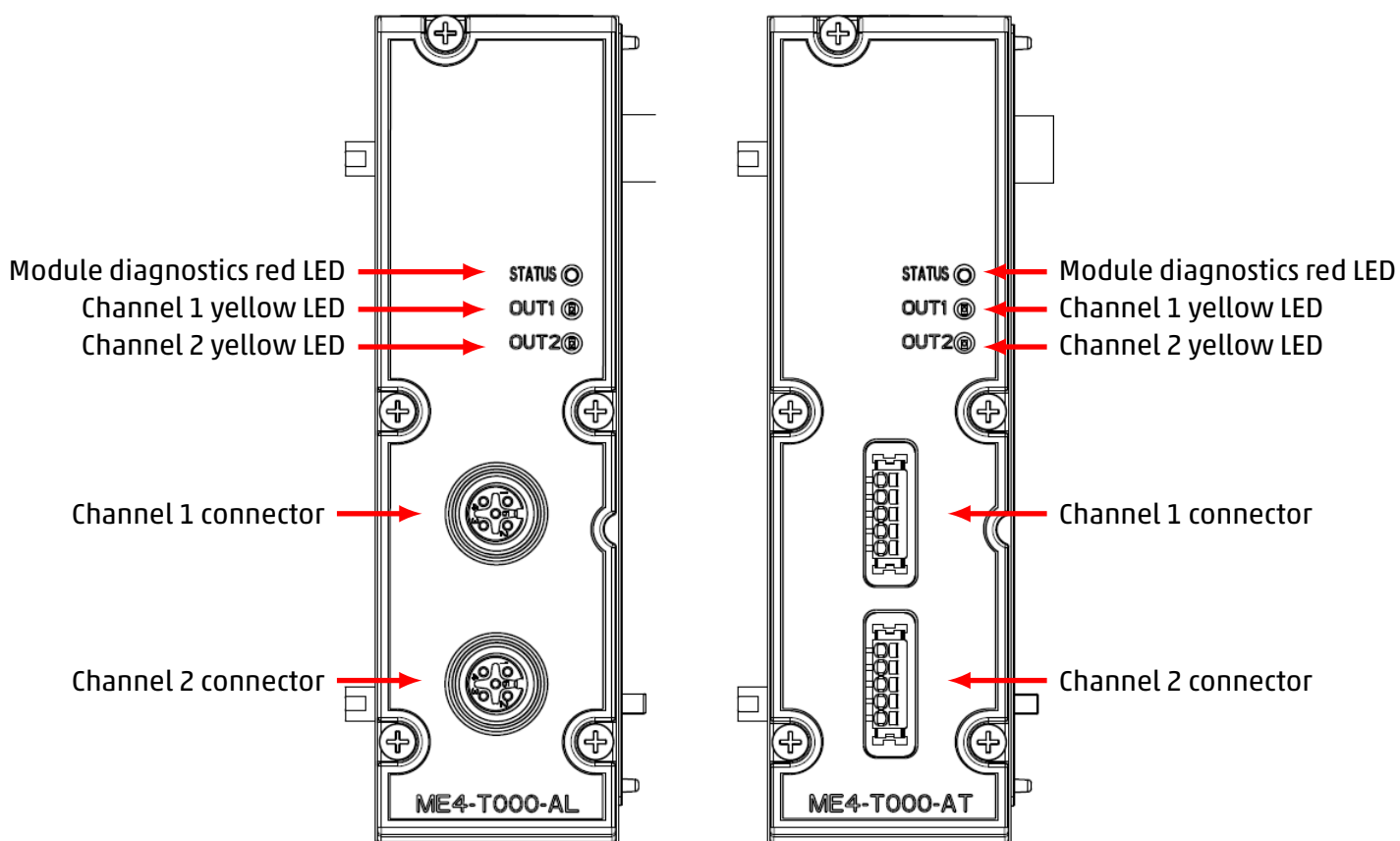















### Electrical connections







Pin	Signal	Description	M12A connector	TB connector
1	+24EX	24V auxiliary voltage		
2	OUT	Voltage or current signal output		
3	GND	Earth		
4	NC	Not connected		
5	NC	Not connected		

**NOTE.** Maximum absorption value: 200mA per channel or 400mA if there is only one sensor powered by the board

**6.5.4 Module diagnostics**

Module status and alarms	LED STATUS	LED IN1	LED IN2	Description of the status and solutions of the alarms
Waiting for configuration parameters	 1 flash RED @100 ms every 2 s	 YELLOW OFF	 YELLOW OFF	The module is waiting for configuration parameters (maximum duration 1 minute).
Output working (Channel 1)	 RED OFF	 YELLOW ON	 YELLOW OFF	The output to channel 1 is functioning correctly.
Output working (Channel 2)	 RED OFF	 YELLOW OFF	 YELLOW ON	The output to channel 2 is functioning correctly.
Communication fault	 2 flashes RED @100 ms every 2 s	 2 flashes YELLOW @100 ms every 2 s	 2 flashes YELLOW @100 ms every 2 s	Communication fault between head and module. <b>Solution:</b> contact support and replace the module.
No load (Channel 1)	 3 flashes RED @100 ms every 2 s	 3 flashes YELLOW @100 ms every 2 s	 YELLOW OFF	Load on the output 1 not present (This error is valid only for the current configuration). <b>Solution:</b> check connections with the load and restart the module.



Module status and alarms	LED STATUS	LED IN1	LED IN2	Description of the status and solutions of the alarms
<p>No load (Channel 2)</p>	 3 flashes RED @100 ms every 2 s	 YELLOW OFF	 3 flashes YELLOW @100 ms every 2 s	<p>Load on the output 2 not present (This error is valid only for the current configuration).  <b>Solution:</b> check connections with the load and restart the module.</p>
<p>Module error</p>	 4 flashes RED @100 ms every 2 s	 4 flashes YELLOW @100 ms every 2 s	 4 flashes YELLOW @100 ms every 2 s	<p>Occurs in case of the following problems:</p> <ul style="list-style-type: none"> <li>• Overheating</li> <li>• Undervoltage power supply</li> <li>• Internal DAC error</li> </ul> <p><b>Solution:</b> contact support and replace the module.</p>

# Commissioning

## 7.1 Electrical connections

The following steps are recommended for the correct electrical connection of the system:

- Connect the IN connector to the PROFINET/IO network coming from the controller (or PLC).
- Connect the OUT connector to the next device in the PROFINET/IO network. If this connector is not used, close with the appropriate cap to ensure IP65 protection.
- Connect the power supply connector.

**NOTE.** The dedicated caps for IP65 protection of our connectors (for digital and analogue input/output modules and subnet) can be found in the Camozzi catalogue:

- CS-DFTP, M8 connector cover cap.
- CS-LFTP, M12 connector cover cap.

## 7.2 Start-up operation

The CX4 module performs a system-wide configuration check at start-up. This is called *mapping*. Specifically, the system configuration is determined by the type and position of the coil valve subbases and connected I/O modules. The system mapping is saved in the CX4 module's internal memory. If the mapping has never been stored or the configuration of the system has been modified, a new mapping request must be made (par. 7.3). During the mapping operation, the general diagnostic LEDs of each connected accessory device light up in sequence, first on the coil valve side and then on the I/O module side.

- If the mapping finishes successfully, the CX4 moves on to the next stage. Furthermore, the diagnostic LEDs of each recognized module are switched off.
- If the mapping is not completed correctly, a diagnostic alarm will be triggered (par. 8.1.2) and the CX4 module will not proceed with any other operations.

The second step at system start-up is the configuration of parameters. The CX4 will wait for a maximum of 1 minute for any parameters from the controller/PLC, otherwise the parameters saved in internal memory or the default parameters will be loaded. While waiting for the configuration parameters, the LEDs of the I/O modules flash until this operation is complete (The type of flashing is defined for each individual accessory module in chapter 6).

At the end of this second start-up phase, the system, managed by the CX4 module, switches into normal operation mode and is ready to perform the required operations.

### 7.3 Mapping

The CX4 module, in CX4 Series serial module or Series D serial valve island configuration, is extremely flexible and its configuration can be modified by removing, replacing or changing the positions of the coil valve subbases and/or I/O modules. Each time a change is made, the mapping procedure must be carried out again to correctly configure the entire system. The CX4 module must be aware of the composition of the entire island: number, type and location of coil valve subbases and I/O modules.

The mapping operation can be performed with the use of software, by sending a request for new mapping, without having to physically work with the island. A new mapping can be requested in the following ways:

- Camozzi UVIX as Gateway-USB (par. 9.8).
- NFCamApp, smartphone app (par. 10.6).

**NOTE.** Once the mapping request has been made, the CX4 module must be restarted.

### 7.4 PROFINET/IO name assignment

As an Ethernet-type fieldbus device, the CX4 PROFINET/IO module must have a unique name (STATION NAME) and a unique address (IP ADDRESS) normally assigned directly by the PLC, in order to be correctly identified on the PROFINET/IO network.

The default settings for our system are as follows:

- Station name: " "
- IP address: 0.0.0.0
- Network mask: 0.0.0.0
- Gateway: 0.0.0.0

There are several ways to edit the default information:

- Camozzi UVIX as browser interface (par. 9.2.2)
- NFCamApp, smartphone app (par. 10.5).
- Controller / PLC programming software.

**N.B.** If communication between the CX4 and the controller/PLC is not established, the problem is signalled by the bus diagnostic LEDs.

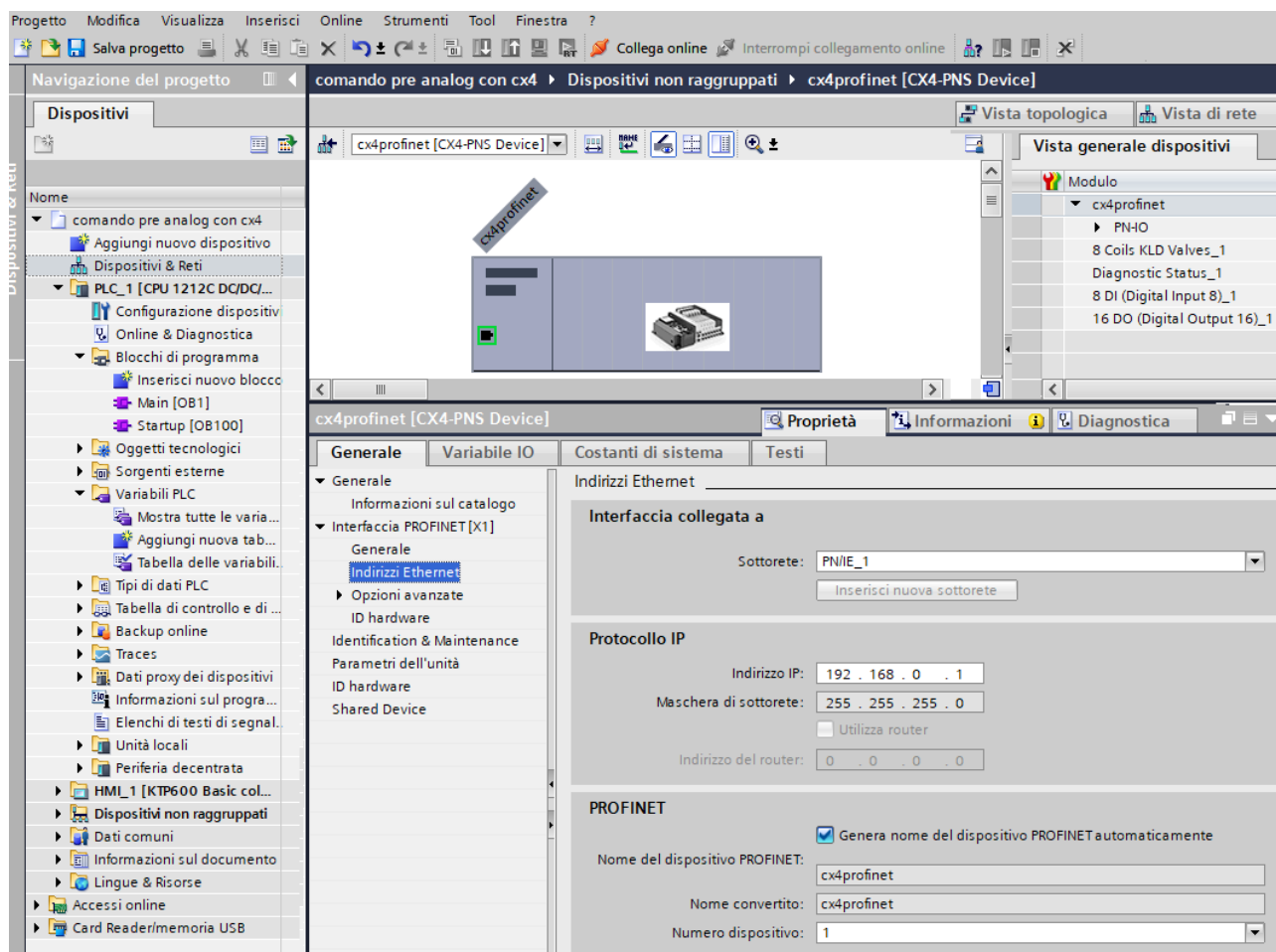

### 7.5 Configuration via GSDML file

To configure the valve island on the PROFINET/IO network, the GSD file must be imported into the programming software used for the controller. The configuration file describes the characteristics of the PROFINET/IO valve island and allows the Input/Output to be correctly configured.

The GSD file is provided in the GSDML language and can be found on the Camozzi website at the following address:

<http://catalogue.camozzi.com/Downloads>

## 7.6 Address assignment

The volume of addresses of the Series D valve island in the PROFINET/IO network is limited as shown in the table.

**NOTE.** The maximum limit of 32 usable slots must still be respected. Therefore, the maximum number of I/O modules is 32 in total (the subbases occupy just one slot, the second fixed).

Modules	Number of channels	Bytes per single module	Number of connectable modules	Assigned address volume	Maximum number of I/Os
Valve subbases	2	2 bits per coil	64	16 bytes	128 coils
8-channel digital input modules	8	1 byte	16	16 bytes	128 digital inputs
16-channel digital input modules	16	2 bytes	8	16 bytes	128 digital inputs
8-channel digital output modules	8	1 byte	16	16 bytes	128 digital outputs
16-channel digital output modules	16	2 bytes	8	16 bytes	128 digital outputs
Analogue input modules for RTD	2	4 bytes	8	32 bytes	16 analogue inputs for RTD
Analogue input modules for Thermocouples	2	4 bytes	8	32 bytes	16 analogue inputs for Thermocouples
Analogue input modules for BRIDGE	2	8 bytes	4	32 bytes	8 analogue inputs for BRIDGE
Analogue input modules for Voltage/Current	2	4 bytes	8	32 bytes	16 Analogue inputs for Voltage/Current

## Chapter 7 Commissioning

<b>Modules</b>	<b>Number of channels</b>	<b>Bytes per single module</b>	<b>Number of connectable modules</b>	<b>Assigned address volume</b>	<b>Maximum number of I/Os</b>
Analogue output modules for Voltage/Current	2	4 bytes	8	32 bytes	16 Analogue outputs for Voltage/Current

## 7.7 Cyclical data

The data exchanged in cyclic mode between the CX4 module and the controller/PLC represent the usual input and output streams of PROFINET/IO real-time communication.

The first byte of the input stream is always present (slot 2) and is the byte of general island diagnostics (see the paragraph 8 on general island diagnostics). If present and based on the set position (slot, sub-slot) in the master configuration tool, the data of the digital and analogue inputs follow.

For the output stream, slot 1 is reserved for valves and can occupy a number of bytes at least equal to 1 (8 coils) and at most 16 (128 coils); if the island has no valves, slot 1 can be removed from the configuration tool; the following bytes of the output stream represent, according to the set position (in terms of slot/subslot) in the configurator, the data of the digital outputs (and in the future of the analogue outputs).

### 7.8 Acyclic data

It is possible to use acyclic packets to retrieve some information on the operation of the island as well as set some application-specific parameters at start-up or send appropriate commands.

#### 7.8.1 Read variables

The following information can be retrieved via the acyclic read command (consult the PLC manufacturer's manual), specifying the *API*, *Slot*, *Subslot* and *Index* fields indicated in the following table.

Description	Api	Slot	Subslot	Index	Dimension	Value
System Start	0	0	1	1	1 byte	1 = parameters set by PLC 0 = internal memory parameters
Firmware version CX4 module	0	0	1	2	2 byte	Byte 0 = Major version Byte 1 = Minor version
Valve health status	0	1	1	100 (0x64)	1 byte per coil	0÷100 [%]
Valve cycle counter	0	1	1	101 (0x65)	4 bytes per coil	0÷2 <sup>32</sup> [No. of cycles]
Valve error counter	0	1	1	102 (0x66)	4 bytes per coil	0÷2 <sup>32</sup> [No. of errors]
Generic variables CX4 module	0	1	1	105 (0x69)	5 bytes	Byte 0-1: Power supply [dV] Byte 2-3: Logic supply [dV] Byte 4: Temperature [°C]



### 7.8.2 Commands

The following objects allow commands to be sent to the application, via acyclic packets.

Description	Api	Slot	Subslot	Index	Dimension	Value
Mapping request	0	0	1	101 (0x65)	0 byte	
Reset subbase information	0	1	1	100 (0x64)	1 byte	1-64 (ID number of the subbase to be reset)

### 7.8.3 Module parameterisation

The following application parameters can be configured, on the controller/PLC side, using acyclic write commands.

They are described in the GSDML file, within the definitions of the various modules, and their descriptions are in English (as in the *Parameter* column of the following tables).

For the application parameters to be effectively implemented, you must ensure the following conditions are met.

- The *System Start* head parameter must be set to 1 (*External*).
- The module must not already be operational, as the parameters are only applied in the boot phase.

**NOTE.** The subbases parameters for Series D valves and I / O modules, which can be connected to the CX4 main module, can also be configured via the UVIX user interface (ch. 9).

#### 7.8.3.1 Modulo CX4 PROFINET/IO

The *System Start* allows the CX4 head to work in two alternative modes: if left at the default value (0), all the application parameters described in the following paragraphs, although still transmitted, are ignored by the CX4 module software, which instead will apply the values already stored in its own non-volatile memory; this is because a CX4 module can normally be configured not only with a PLC, but also using UVIX, and because of this we wanted to add the option not to overwrite any pre-existing configuration. If, on the other hand, this parameter is set to 1, any parameterization carried out on the master tool will be applied by the head software at the end of the boot phase. The *Under Voltage Alarm Severity* parameter specifies a behaviour which only relates to the power supply undervoltage alarm, which can be detected by the CX4 module but also by any digital output modules connected to it. In the default case (1 = fault), the alarm, if detected, is also transmitted as a PROFIBUS/DP diagnostic package, otherwise (0) will only be present in the *Diagnostic State* of the system, i.e. in the first byte of the cyclic image of the input (par. 8.1.2).

Description	Parameter	Dimension	Value
Parameter use mode	System Start	1 bit	1 = parameters set by PLC 0 = internal memory parameters
Severity management of the undervoltage alarm (CX4, Digital outputs)	Under Voltage Alarm Severity	1 bit	1 = fault (maximum severity) 0 = no Error (simple warning in the Diagnostic State)

### 7.8.3.2 Series D valve subbases

The subbases that control the Series D coil valves can be configured in the management of the *failsafe* operation and in the management of piloting errors in the coil valves themselves, as described in the 6.1.3.

Description	Parameter	Dimension	Value
Failsafe enable	Fail Safe Enable	1 bit per coil	Disabled (0) = failsafe not enabled Enabled (1) = failsafe enabled
Failsafe status	Fail Safe Status	1 bit per coil	Reset (0) = status not active Set (1) = active status in case of failsafe enabled
Blocking alarm management for coil fault (interrupted and overcurrent)	Error Enable	1 bit per sottobase	Unlatched (0) = recovery error Latched (1) = non recovery error

### 7.8.3.3 Digital inputs

The configuration parameters for the digital input modules make it possible to act on both the input reading logic (*Minimum Activation Time*) and on the temporal characteristics of the signals read (*Extension Time*), as described in the 6.2.1.

Description	Parameter	Dimension	Value
Polarity of a channel	Signal Activation Mode	1 bit per channel	High (1) = high active input Low (0) = low active input
Minimum dwell time of the input level (anti-bounce filter)	Signal Minimum Activation Time	1 byte	0 = filter disabled 1÷255 [ms]
Minimum period for re-reading the inputs	Signal Extension Time	2 bytes	0 = filter disabled 1÷1023 [ms]
Power source (only for 16-channel digital inputs)	Power Source	1 bit	Internal (0) = power connected to internal source External (1) = power connected to external source

**7.8.3.4 Digital outputs**

The configuration parameters of the digital output modules can be divided into several categories: activation mode, safety management with failsafe and PWM signal generation, as described in the [6.3.1](#).

Description	Parameter	Dimension	Value
Module settings	Module Settings	1 byte	Bit 0 = Open Load Detection (1 = Enabled, 0 = Disabled) Remaining Bits = t.b.d.
Enable channels	Enable Output Channels	1 bit per channel	Disabled (0) = channel disabled Enabled (1) = channel enabled
Channel Type Setting (N/P)	Output Channels Mode	1 bit per channel	Mode N (0) = type N channel Mode P (1) = type P channel
Fail safe enable	Fail Safe Enable	1 bit per channel	Disabled (0) = failsafe not enabled Enabled (1) = failsafe enabled on channel
Fail safe status	Fail Safe Status	1 bit per channel	Reset (0) = status not active on channel Set (1) = active status on channel in case of failsafe enabled
Channel Type Setting PWM	Pwm Channels	1 bit per channel	ON/OFF (0) = channel on/off (no Pwm) PWM (1) = Pwm type channel
PWM activation time	Pwm Activation Time	1 byte per module	0÷255 [ms]
Duty cycle per channel (Configurable if in PWM mode)	Pwm Channels Duty Cycle (%)	1 byte per channel	0÷100 [%]

### 7.8.3.5 Analogue inputs

The configurable parameters are the type of inputs, the transmission parameters and the filters to be applied to the inputs, as described in the 6.4.2.

#### RTD

Description	Parameter	Dimension	Value
RTD sensor type Channel 1/2	Sensor Type → Sensor Type Ch. 1/2	4 bits	0000 = not connected 0001 = PT100 (385) 0010 = PT200 (385) 0011 = PT500 (385) 0100 = PT1000 (385) 0101 = Ni100 (618) 0110 = Ni120 (672) 0111 = Ni1000 (618) 1000 = PT100 (3926)
RTD number of wires Channel 1/2	Sensor Wires → Sensor Sensor Wires Ch. 1/2	2 bits	0 = 2 wires 1 = 3 wires 2 = 4 wires
Board transmission threshold in relative units 1 U = 0.1 °C	Sampling Threshold → Threshold	4 bits	0000 = disabled 0001 = 1 U (0.1 °C) 0010 = 2 U 0011 = 3 U 0100 = 4 U 0101 = 5 U 0110 = 10 U 0111 = 20 U 1000 = 30 U 1001 = 40 U 1010 = 80 U 1011 = 100 U 1100 = 160 U 1101 = 500 U 1110 = 1000 U 1111 = 2000
Threshold transmission timeout	Sampling Threshold → Timeout (s)	4 bits	1÷15 s

Description	Parameter	Dimension	Value
Transmission frequency to the master (timed mode) or upper frequency limit (threshold mode)	Sampling Frequency → Frequency	4 bits	0000 = disabled 0001 = 1 Hz 0010 = 2 Hz 0011 = 5 Hz 0100 = 10 Hz 0101 = 25 Hz 0110 = 50 Hz 0111 = 100 Hz 1000 = 250 Hz 1001 = 500 Hz 1010 = 1000 Hz
Moving Average Filter Length Channel 1/2	FIR Length → Channel 1/2	1 byte	0÷1 = disabilitato 2÷128 [no. of filter caps]

**Thermocouples**

Description	Parameter	Dimension	Value
Sensor type TC Channel 1/2	Sensor Type → Sensor Type Ch. 1/2	4 bits	0000 = not connected 0001 = B 0010 = E 0011 = J 0100 = K 0101 = N 0110 = R 0111 = S 1000 = T
Board transmission threshold in relative units 1 U = 0.1 °C	Sampling Threshold → Threshold	4 bits	0000 = disabled 0001 = 1 U (0.1 °C) 0010 = 2 U 0011 = 3 U 0100 = 4 U 0101 = 5 U 0110 = 10 U 0111 = 20 U 1000 = 30 U 1001 = 40 U 1010 = 80 U 1011 = 100 U 1100 = 160 U 1101 = 500 U 1110 = 1000 U 1111 = 2000 U
Threshold transmission timeout	Sampling Threshold → Timeout (s)	4 bits	1÷15 s



Description	Parameter	Dimension	Value
Transmission frequency to the master (timed mode) or upper frequency limit (threshold mode)	Sampling Frequency → Frequency	4 bits	0000 = disabled 0001 = 1 Hz 0010 = 2 Hz 0011 = 5 Hz 0100 = 10 Hz 0101 = 25 Hz 0110 = 50 Hz 0111 = 100 Hz 1000 = 250 Hz 1001 = 500 Hz 1010 = 1000 Hz
Moving Average Filter Length Channel 1/2	FIR Length → Channel 1/2	1 byte	0÷1 = disabilitato 2÷128 [no. of filter caps]

**Bridge**

Description	Parameter	Dimension	Value
Bridge Factor Channel 1/2	Sensor Type → Bridge Factor Ch. 1/2 (mV/Vdc)	1 byte	0 = not connected 1÷255 mV/Vdc
Board transmission threshold in relative units 1 U = 0.1 $\mu$ V	Sampling Threshold → Threshold	4 bits	0000 = disabled 0001 = 1 U (1 $\mu$ V) 0010 = 2 U (2 $\mu$ V) 0011 = 3 U 0100 = 4 U 0101 = 5 U 0110 = 10 U 0111 = 20 U 1000 = 30 U 1001 = 40 U 1010 = 80 U 1011 = 100 U 1100 = 160 U 1101 = 500 U 1110 = 1000 U 1111 = 2000 U
Threshold transmission timeout	Sampling Threshold → Timeout (s)	4 bits	1÷15 s
Transmission frequency to the master (timed mode) or upper frequency limit (threshold mode)	Sampling Frequency → Frequency	4 bits	0000 = disabled 0001 = 1 Hz 0010 = 2 Hz 0011 = 5 Hz 0100 = 10 Hz 0101 = 25 Hz 0110 = 50 Hz 0111 = 100 Hz 1000 = 250 Hz 1001 = 500 Hz 1010 = 1000 Hz

## Chapter 7 Commissioning

Description	Parameter	Dimension	Value
Moving Average Filter Length Channel 1/2	FIR Length → Channel 1/2	1 byte	0÷1 = disabilitato 2÷128 [no. of filter caps]

**Voltage/Current**

Description	Parameter	Dimension	Value
Input type V/C Channel 1/2	Sensor Type → Sensor Type Ch. 1/2	3 bits	000 = not connected 001 = 0 ÷ 10 V 010 = -10 ÷ +10 V 011 = 4 ÷ 20 mA 100 = 0 ÷ 20 mA 101 = -20 ÷ +20 mA
Board transmission threshold in relative units 1 U = 1 mV o 1 μA	Sampling Threshold → Threshold	4 bits	0000 = disabled 0001 = 1 U (1 μV) 0010 = 2 U (2 μV) 0011 = 3 U 0100 = 4 U 0101 = 5 U 0110 = 10 U 0111 = 20 U 1000 = 30 U 1001 = 40 U 1010 = 80 U 1011 = 100 U 1100 = 160 U 1101 = 500 U 1110 = 1000 U 1111 = 2000 U
Threshold transmission timeout	Sampling Threshold → Timeout (s)	4 bits	1 ÷ 15 s

## Chapter 7 Commissioning

Description	Parameter	Dimension	Value
Transmission frequency to the master (timed mode) or upper frequency limit (threshold mode)	Sampling Frequency → Frequency	4 bits	0000 = disabled 0001 = 1 Hz 0010 = 2 Hz 0011 = 5 Hz 0100 = 10 Hz 0101 = 25 Hz 0110 = 50 Hz 0111 = 100 Hz 1000 = 250 Hz 1001 = 500 Hz 1010 = 1000 Hz
Moving Average Filter Length Channel 1/2	FIR Length → Channel 1/2	1 byte	0÷1 = disabilitato 2÷128 [no. of filter caps]

### 7.8.3.6 Analogue outputs

The configurable parameters are the type of outputs and the safety management with failsafe, as described in the [6.5.2](#).

Description	Parameter	Dimension	Value
Output type V/C Channel 1/2	Channel Configuration → Channel 1/2	1 byte	0 = disabled 1 = 0÷10 V 2 = 0÷5 V 3 = 4÷20 mA 4 = 0÷20 mA
Enable failsafe Channel 1/2	Fail Safe Enable → Channel 1/2	1 bit	0 = disabled 1 = channel enabled
Failsafe value Channel 1/2	FailSafe Value → Channel 1/2	2 bytes	In mV/uA: <ul style="list-style-type: none"> <li>• 0÷10000 if channel 0÷10 V</li> <li>• 0÷5000 if channel 0÷5 V</li> <li>• 4000÷20000 if channel 4÷20 mA</li> <li>• 0÷20000 if channel 0÷20 mA</li> </ul>

### 7.9 MRP Support

MRP is the basic Ethernet protocol for transmission media redundancy and should be applied when using network ring topologies. MRP allows maintaining the connection between devices in case of failure of a link or node in the ring, or rather to restore the link in a very short time (<300 ms).

CX4 supports S1 MRP configuration, which is the standard PROFINET/IO configuration for devices that have only one network interface (NAP, Network Access Point) and only one communication relationship (AR, Application Relationship) with the controller. This means that in the event of a link or device failure in the network ring, the S1 device can continue to communicate with the controller. The converse, on the other hand, cannot be applied if it is the controller (PLC) that fails, because an S1-type device has no connection redundancy to a second controller.

The S1 type is suitable for standard real-time (RT) PROFINET/IO applications, but not for isochronous real-time (IRT) applications, which require the S2.

The following images are from the [Profinet University](#), and they clarify all the possible configurations provided by MRP, even the "R" type configurations that we have not mentioned and that assume hardware redundancy (network interfaces and links).

S1 and S2 system redundancy are implemented with a single NAP. S1 is actually not redundant at all, while S2 is the most simple redundant connection.

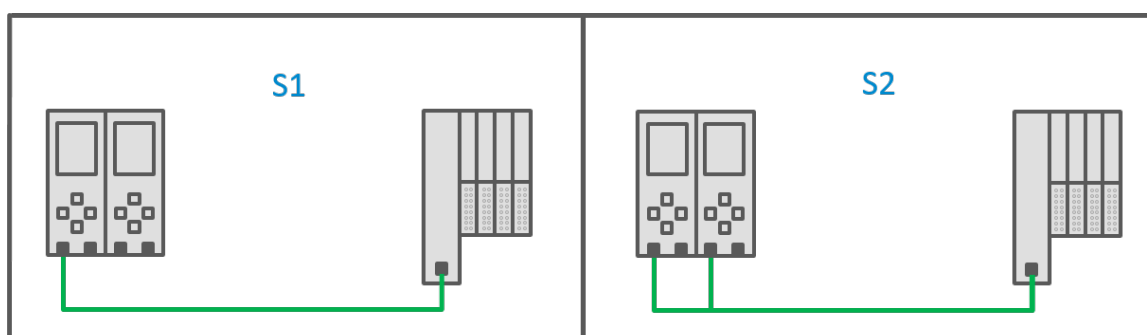

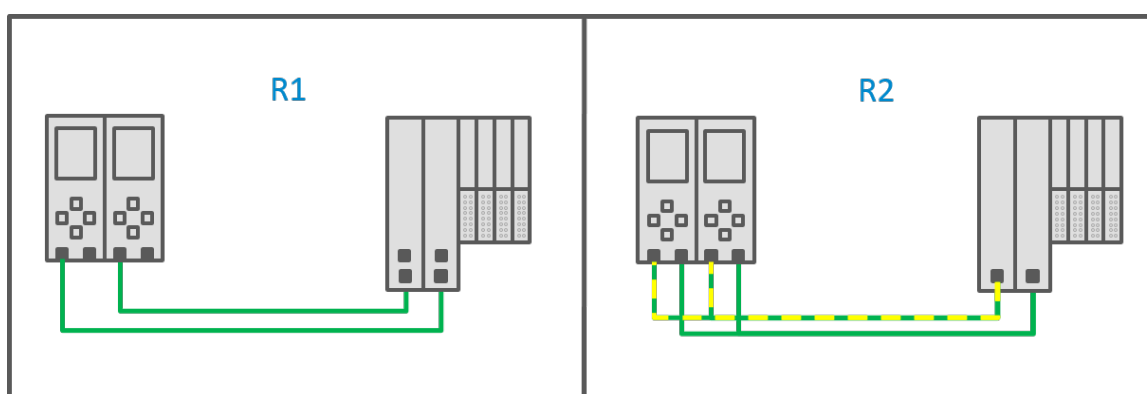

R1 redundancy on the left is functionally equivalent to S2 redundancy, without the single point of failure in the NAP. R2 redundancy adds yet another level of assurance and high availability.



# Diagnostic

The diagnostics of the CX4 PROFINET/IO module is defined in three different ways.

- The status of the LEDs on the CX4 or on the individual modules connected to it [6](#). The following table provides the typical behaviour of the LEDs on our modules. The colour of the LEDs can be different for each module (the table refers to a red LED).

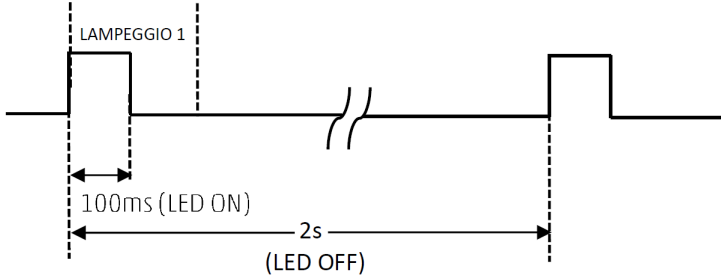
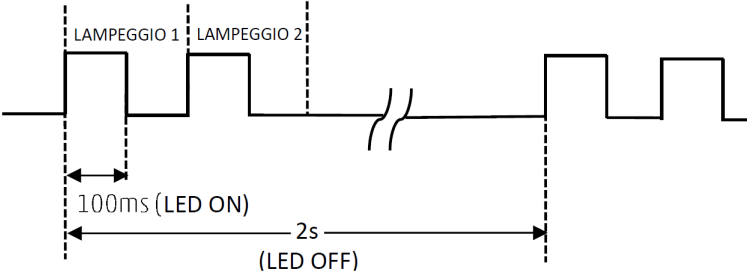
Symbol	LED state	Description
	RED OFF	Led is OFF
	RED ON	Led is ON
	FLASHING	<p>The led flashes with a specified sequence for each diagnostic state: @XX [ms/Hz] per YY [s]</p> <ul style="list-style-type: none"> <li>• XX is the ON time of a led flashing. The flashing sequence is represented by an ON state and an OFF state of the same time.</li> <li>• YY is the time of the repeated flashing sequence.</li> </ul> <p><b>Example 1:</b> 1 flash @100 ms every 2 s</p>  <p><b>Example 2:</b> 2 flashes @100 ms every 2 s</p> 



## Chapter 8 Diagnostic

- I messaggi software che vengono instradati sulla rete PROFINET/IO.

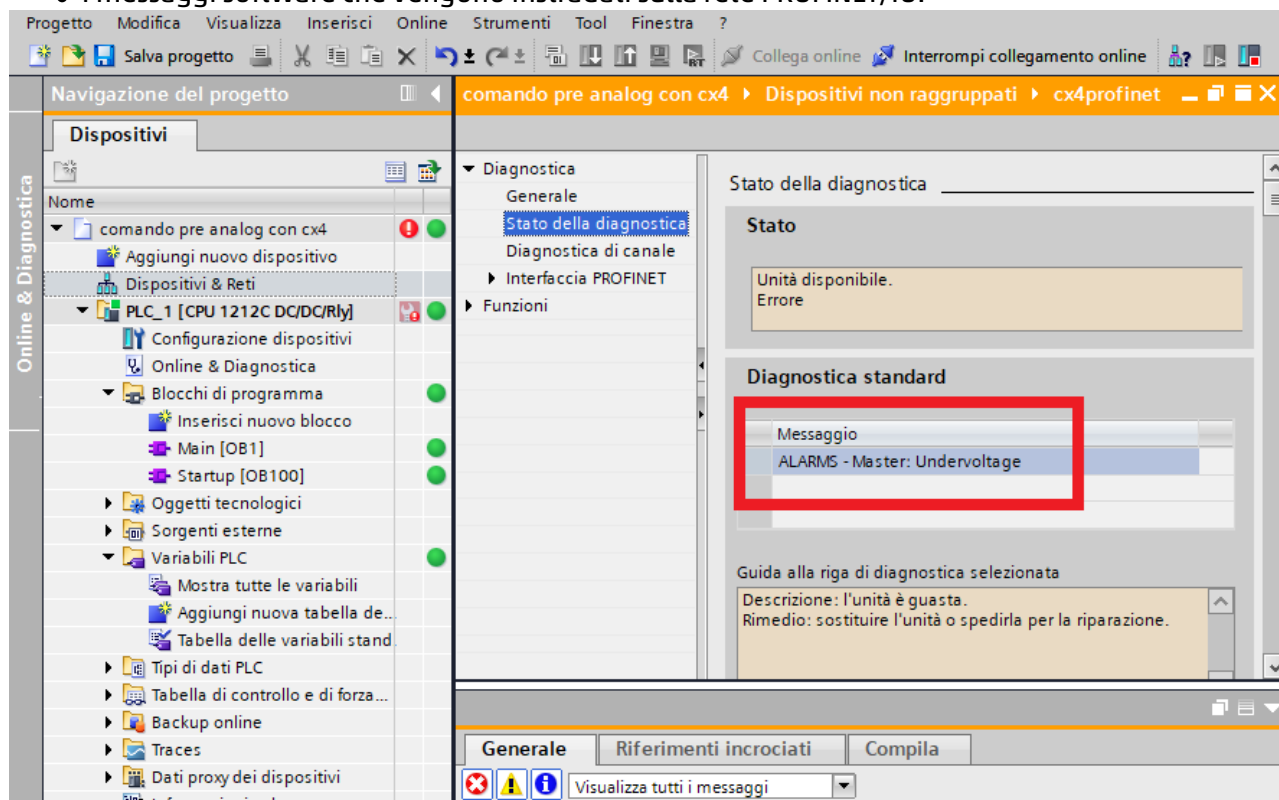









- The UVIX user interface (ch. 9)

## 8.1 CX4 module



### 8.1.1 PROFINET/IO node





Diagnostics of the PROFINET/IO node are defined by the status of the link L/A1 and link L/A2 LEDs, SF (System Failure) and BF (Bus Failure) LEDs.





LED	Operation	Description
SF	 RED OFF	No error.
	 RED ON	System error.
	 Flashing RED @2Hz for 3s	Initialisation of the DCP service.
BF	 RED OFF	No error.
	 RED ON	The configuration or parameterisation of the device is incorrect.
	 Flashing RED @2Hz	No data exchange with the controller/PLC. Connection to the network is interrupted or defective. The device name or IP address is incorrect.
L/A1 L/A2	 GREEN OFF	No connection to the PROFINET/IO network.
	 GREEN ON	The device is connected to the network but there is no data exchange.
	 Flashing GREEN	The device is communicating correctly with the PROFINET/IO network.

### 8.1.2 CX4 system diagnostics

The diagnostics of the CX4 system is managed by the SYS diagnostic LED, by messages transmitted to the controller/PLC defined in the PROFINET/IO protocol and by the display on the UVIX interface.

Module status and alarms	SYS LED	Diagnostic Status (Byte 0 stream IN)	PROFINET/IO Code (Extended Error Type)	Extra Info PROFINET/IO	UVIX
Normal operation	 1 flash GREEN @100 ms every 1 s	0x00			
I/O modules absent	 1 flash GREEN @100 ms every 1 s	0x01			I/O modules absent
Valves absent	 1 flash GREEN @100 ms every 1 s	0x02			Valves absent

Module status and alarms	SYS LED	Diagnostic Status (Byte 0 stream IN)	PROFINET/IO Code (Extended Error Type)	Extra Info PROFINET/IO	UVIX
Valves substitution	 1 flash GREEN @100 ms every 1 s	0x03	21 (0x15)	Api = 0 Slot = 1 Subslot = 1 Channel Number = [absolute progressive ID of the first coil of the subbase] Error Type = 0x100 Extra Info = [subbase number] (for Tia Portal)	Valve Subbase Substitution
Fieldbus fatal error	(Alternated flashing)  1 flash GREEN @400 ms every 0.5 s  1 flash RED @400 ms every 0.5 s	0xF0			Fieldbus fatal error
Overheating alarm	 RED ON	0xFB	3 (0x03)	Api = 0 Slot = 0 Subslot = 1 Error Type = 0x100	Overheating CX4 module

Module status and alarms	SYS LED	Diagnostic Status (Byte 0 stream IN)	PROFINET/IO Code (Extended Error Type)	Extra Info PROFINET/IO	UVIX
Undervoltage alarm	 RED ON	0xFC	4 (0x04)	Api = 0 Slot = 0 Subslot = 1 Error Type = 0x100	Undervoltage CX4 module
Alarm of mapping I/O modules error	 2 flashes RED @100 ms every 1 s	0xFD	5 (0x05)	Api = 0 Slot = 0 Subslot = 1 Error Type = 0x100	Mapping I/O modules error
Alarm of mapping valves error	 2 flashes RED @100 ms every 1 s	0xFE	2 (0x02)	Api = 0 Slot = 0 Subslot = 1 Error Type = 0x100	Mapping valves error
Alarm of mapping absent	 1 flash RED @100 ms every 1 s	0xFF	1 (0x01)	Api = 0 Slot = 0 Subslot = 1 Error Type = 0x100	Mapping absent
Alarms of valve errors or I / O module errors	 3 flashes RED @100 ms every 1 s	<b>NOTE.</b> The diagnostic states and PROFINET/IO and UVIX codes are specified for each single module in the following tables.			

### 8.1.3 Replace solenoid valve

This *warning* indicates that the optimal performance of at least one solenoid valve has deteriorated and is no longer guaranteed.

**Solution:** replace the deteriorated solenoid valve.

**NOTE.** To find out which solenoid valves on the island are in these conditions, you need to connect to the Camozzi user interface (UVIX) and check the health status of the individual solenoid valves (par. 9.3.4).

### 8.1.4 Fieldbus fatal error

This alarm can occur for two reasons.

- The fieldbus has been programmed incorrectly and the board has no MAC address.
- The fieldbus version loaded on the board is incorrect.

**Solution:** reprogram the board with the correct firmware (par. 9.8). If the problem persists, contact Camozzi support.

### 8.1.5 Over-temperature alarm

The CX4 module has reached or exceeded the limit temperature over which the normal operation of the device is not guaranteed and, if the condition persists, this can lead to the failure of a component on the board.

**Solution:** restart the island; if the problem persists, contact Camozzi support.

### 8.1.6 Undervoltage alarm

The CX4 module is powered with a voltage lower than the minimum acceptable value; therefore, correct operation of the system is not guaranteed.

**Solution:** check that the wiring is correct and that the wires are properly inserted into the connector. Check that the logic supply (pins 1 and 3) and power supply (pins 2 and 5) are physically present on the connector. If the problem persists, contact Camozzi support.

### 8.1.7 I/O module mapping error

During the mapping phase (par. 7.3), an error has occurred on the I/O modules. The mapping has failed at the first I/O module with the diagnostic LED off.

**Solution:** repeat the mapping procedure and replace where necessary the I/O module where the mapping ends (first I/O module with diagnostic LED off). If the problem persists, contact Camozzi support.

### 8.1.8 Solenoid valve mapping error

During the mapping phase (par. 7.3), a solenoid valve error has occurred on the subbase. The mapping has failed at the first subbase with the diagnostic LED off.

**Solution:** repeat the mapping procedure and replace where necessary the subbase where the mapping ends (first subbase with diagnostic LED off). If the problem persists, contact Camozzi support.

### 8.1.9 No mapping

After requesting a new system mapping (par. 7.3), an error has occurred both on the I/O modules and on the solenoid valve subbases. The mapping ends at the first accessory module (I/O module or subbase) with the diagnostic LED off.

**Solution:** repeat the mapping procedure and replace where necessary the accessory module where the mapping ends (first accessory module with diagnostic LED off). If the problem persists, contact Camozzi support.

### 8.1.10 Solenoid valve or I/O module alarms

These alarms are specific for each individual accessory module. The UVIX and PROFINET/IO messages are specified in the following tables, while the diagnostics via LEDs - found on each individual module - and the specific solutions are detailed in the accessories section (ch. 6).

## 8.2 Series D valve subbases

The following table shows the diagnostic status of the Series D coil valves, with the respective PROFINET/IO messages and the display on the UVIX interface. The coil valves display a diagnostic signal through LED signalling directly on the subbase where they are mounted. For details regarding LED diagnostics and possible solutions to any alarms, refer to the Accessories chapter (par. 6.1.4).

<b>Module status and alarms</b>	<b>Diagnostic Status (Byte 0 stream IN)</b>	<b>PROFINET/IO Code (Extended Error Type)</b>	<b>Extra Info PROFINET/IO</b>	<b>UVIX</b>
Configuration parameters	0xE6	29 (0x1D)	Api = 0 Slot = 1 Subslot = 1 Channel Number = [absolute progressive ID of the coil (1-128)] Error Type = 0x100 Extra Info = [subbase number] (for Tia Portal)	
Overheating subbase	0xE8	28 (0x1C)	Api = 0 Slot = 1 Subslot = 1 Channel Number = [absolute progressive ID of the coil (1-128)] Error Type = 0x100 Extra Info = [subbase number] (for Tia Portal)	Overheating subbase
Overheating coil (Position 14/12)	0xE9	26 (0x1A)	Api = 0 Slot = 1 Subslot = 1 Channel Number = [absolute progressive ID of the coil (1-128)] Error Type = 0x100	Overheating coil 14/12



<b>Module status and alarms</b>	<b>Diagnostic Status (Byte 0 stream IN)</b>	<b>PROFINET/IO Code (Extended Error Type)</b>	<b>Extra Info PROFINET/IO</b>	<b>UVIX</b>
Overcurrent coil (Position 14/12)	0xEA	25 (0x19)	Api = 0 Slot = 1 Subslot = 1 Channel Number = [absolute progressive ID of the coil (1-128)] Error Type = 0x100	Overcurrent coil 14/12
Interrupted coil (Position 14/12)	0xEB	24 (0x18)	Api = 0 Slot = 1 Subslot = 1 Channel Number = [absolute progressive ID of the coil (1-128)] Error Type = 0x100	Interrupted coil 14/12
Fault coil (Position 14/12)	0xEC	23 (0x18)	Api = 0 Slot = 1 Subslot = 1 Channel Number = [absolute progressive ID of the coil (1-128)] Error Type = 0x100	Fault coil 14/12
Communication alarm	0xEF	20 (0x14)	Api = 0 Slot = 1 Subslot = 1 Channel Number = [absolute progressive ID of the coil (1-128)] Error Type = 0x100 Extra Info = [subbase number] (for Tia Portal)	Communication alarm

### 8.3 Digital Input Module

The following table shows the diagnostic statuses of the digital inputs, with the respective PROFINET/IO messages and the display on the UVIX interface. The digital inputs also display a diagnostic signal via LED signalling directly on the module. Details on LED diagnostics and possible solutions to any alarms can be found in the chapter Accessories (par. 6.2.5).

<b>Module status and alarms</b>	<b>Diagnostic Status (Byte 0 stream IN)</b>	<b>PROFINET/IO Code (Extended Error Type)</b>	<b>Extra Info PROFINET/IO</b>	<b>UVIX</b>
Short circuit on the channel n	0xDD	30 (0x1E)	Api = 0 Slot = 3-32* Subslot bit mask c.c. Error Type = 0x100	Short circuit Group 0-3 Short circuit Group 4-7 Short circuit Group 8-11 Short circuit Group 12-15
Configuration parameters alarm	0xDE	32 (0x20)	Api = 0 Slot = 3-32 Subslot Error Type = 0x100	Configuration alarm
Communication alarm	0xDF	31 (0x1F)	Api = 0 Slot = 3-32 Subslot Error Type = 0x100	Communication alarm

\* In PROFINET/IO messaging, I/O modules can be inserted into slots 3 to 32.

## 8.4 Digital Output Module

The following table shows the diagnostic statuses of the digital outputs, with the respective PROFINET/IO messages and the display on the UVIX interface. The digital outputs display a diagnostic signal via LED signalling directly on the module. Details on LED diagnostics and possible solutions to any alarms can be found in the chapter Accessories (par. 6.2.5).

**NOTE.** The 16-channel digital output modules mandatorily need external power supply.

Module status and alarms	Diagnostic Status (Byte 0 stream IN)	PROFINET/IO Code (Extended Error Type)	Extra Info PROFINET/IO	UVIX
Short circuit on the channel n	0xCA	50 (0x32)	Api = 0 Slot = 3-32** Subslot Channel Number = [channel ID (1-8)] Error Type = 0x100	Short Circuit Channel n
Open circuit on the channel n	0xCB	51 (0x33)	Api = 0 Slot = 3-32** Subslot Channel Number = [channel ID (1-8)] Error Type = 0x100	Open Load Channel n
Undervoltage power line*	0xCC	52 (0x34)	Api = 0 Slot = 3-32 Subslot Channel Number = [bit mask module alarms] Error Type = 0x100	Under Voltage Power Supply
No external power line*	0xCD	53 (0x35)	Api = 0 Slot = 3-32 Subslot Channel Number = [bit mask module alarms] Error Type = 0x100	Zero Voltage Power Supply

<b>Module status and alarms</b>	<b>Diagnostic Status (Byte 0 stream IN)</b>	<b>PROFINET/IO Code (Extended Error Type)</b>	<b>Extra Info PROFINET/IO</b>	<b>UVIX</b>
Configuration parameters alarm	0xCE	55 (0x37)	Api = 0 Slot = 3-32 Subslot Error Type = 0x100	Configuration alarm
Communication alarm	0xCF	54 (0x36)	Api = 0 Slot = 3-32 Subslot Error Type = 0x100	Communication alarm

\* Power supply alarms refer to the external power supply for 16-channel modules.

\*\* In PROFINET/IO messaging, I/O modules can be inserted into slots 3 to 32.

## 8.5 Analogue Input Module

The following table shows the diagnostic statuses of the analogue inputs, with the respective PROFINET/IO messages and the display on the UVIX interface. The analogue inputs display a diagnostic signal via LED signalling directly on the module. Details regarding LED diagnostics and possible solutions to any alarms can be found in the chapter Accessories (par. 6.4.4).

<b>Module status and alarms</b>	<b>Diagnostic Status (Byte 0 stream IN)</b>	<b>PROFINET/IO Code (Extended Error Type)</b>	<b>Extra Info PROFINET/IO</b>	<b>UVIX</b>
Sensor fault on channel 1	0xB6	40 (0x28)	Api = 0 Slot = 3-32* Subslot Channel Number = 1 Error Type = 0x100	Sensor fault channel 1
Missing bridge on channel 1	0xB7	41 (0x29)	Api = 0 Slot = 3-32 Subslot Channel Number = 1 Error Type = 0x100	Missing bridge channel 1
ADC communication alarm	0xB8	42 (0x2A)	Api = 0 Slot = 3-32 Subslot Error Type = 0x100	ADC communication error
Alarm on the voltage reference 3.3V	0xB9	43 (0x2B)	Api = 0 Slot = 3-32 Subslot Error Type = 0x100	RESDCDC error
Sensor fault on channel 2	0xBA	40 (0x28)	Api = 0 Slot = 3-32 Subslot Channel Number = 2 Error Type = 0x100	Sensor fault channel 2

<b>Module status and alarms</b>	<b>Diagnostic Status (Byte 0 stream IN)</b>	<b>PROFINET/IO Code (Extended Error Type)</b>	<b>Extra Info PROFINET/IO</b>	<b>UVIX</b>
Missing bridge on channel 2	0xBB	41 (0x29)	Api = 0 Slot = 3-32 Subslot Channel Number = 2 Error Type = 0x100	Missing bridge channel 1
Configuration parameters alarm	0xBE	45 (0x2D)	Api = 0 Slot = 3-32 Subslot Error Type = 0x100	Configuration alarm
Communication alarm	0xBF	44 (0x2C)	Api = 0 Slot = 3-32 Subslot Error Type = 0x100	Communication alarm

\* In PROFINET/IO messaging, I/O modules can be inserted into slots 3 to 32.

## 8.6 Analogue Output Module

The following table shows the diagnostic statuses of the analogue outputs, with the respective PROFINET/IO messages and the display on the UVIX interface. The analogue outputs display a diagnostic signal via LED signalling directly on the module. Details regarding LED diagnostics and possible solutions to any alarms can be found in the chapter Accessories (par. 6.5.4).

<b>Module status and alarms</b>	<b>Diagnostic Status (Byte 0 stream IN)</b>	<b>PROFINET/IO Code (Extended Error Type)</b>	<b>Extra Info PROFINET/IO</b>	<b>UVIX</b>
Internal error	0xA9	66	Api = 0 Slot = 3-32* Subslot Error Type = 0x100	Internal Error
Open circuit on the channel n	0xAA	60 (0x3C)	Api = 0 Slot = 3-32 Subslot Channel Number = [ID canale (1-2)] Error Type = 0x100	Channel n Open Load
Overheating module	0xAB	61	Api = 0 Slot = 3-32 Subslot Error Type = 0x100	Board Over Heating
Power Supply Short Circuit	0xAC	62	Api = 0 Slot = 3-32 Subslot Error Type = 0x100	Power Supply Short Circuit
Power Supply Under Voltage	0xAD	63	Api = 0 Slot = 3-32 Subslot Error Type = 0x100	Power Supply Under Threshold

<b>Module status and alarms</b>	<b>Diagnostic Status (Byte 0 stream IN)</b>	<b>PROFINET/IO Code (Extended Error Type)</b>	<b>Extra Info PROFINET/IO</b>	<b>UVIX</b>
Configuration parameters alarm	0xAE	65	Api = 0 Slot = 3-32 Subslot Error Type = 0x100	Configuration alarm
Communication alarm	0xAF	64	Api = 0 Slot = 3-32 Subslot Error Type = 0x100	Communication alarm

\* In PROFINET/IO messaging, I/O modules can be inserted into slots 3 to 32.



# Uvix

## 9.1 Introduction

Camozzi's proprietary environment, called UVIX, allows the user to monitor and configure all new generation Camozzi devices (*Camozzi Smart Devices*) that support connection to it. Devices can be connected to UVIX in two ways: wireless or USB. This system has been implemented with a *web-based* architecture so that information can be accessed straightforwardly using a browser.

Monitoring consists of displaying all the device variables, whether they relate to operation, diagnostics, or parameterization.

For details on the UVIX architecture, its installation, and general operations, see the [Manuale UVIX](#).

## 9.2 General information

The devices connected to the UVIX are displayed in a tree diagram **1** consisting of *Device Groups, Family e Devices*. Select one of the components to view in the main window **2** all the information on the various devices and perform configuration operations or manual commands.

By selecting the CX4 module, in Stand-Alone or Valve Island configuration, or individual accessory modules, Series D coil valve subbases or I/O modules, general status information and details can be displayed. These are divided into variables, alarms and controls.

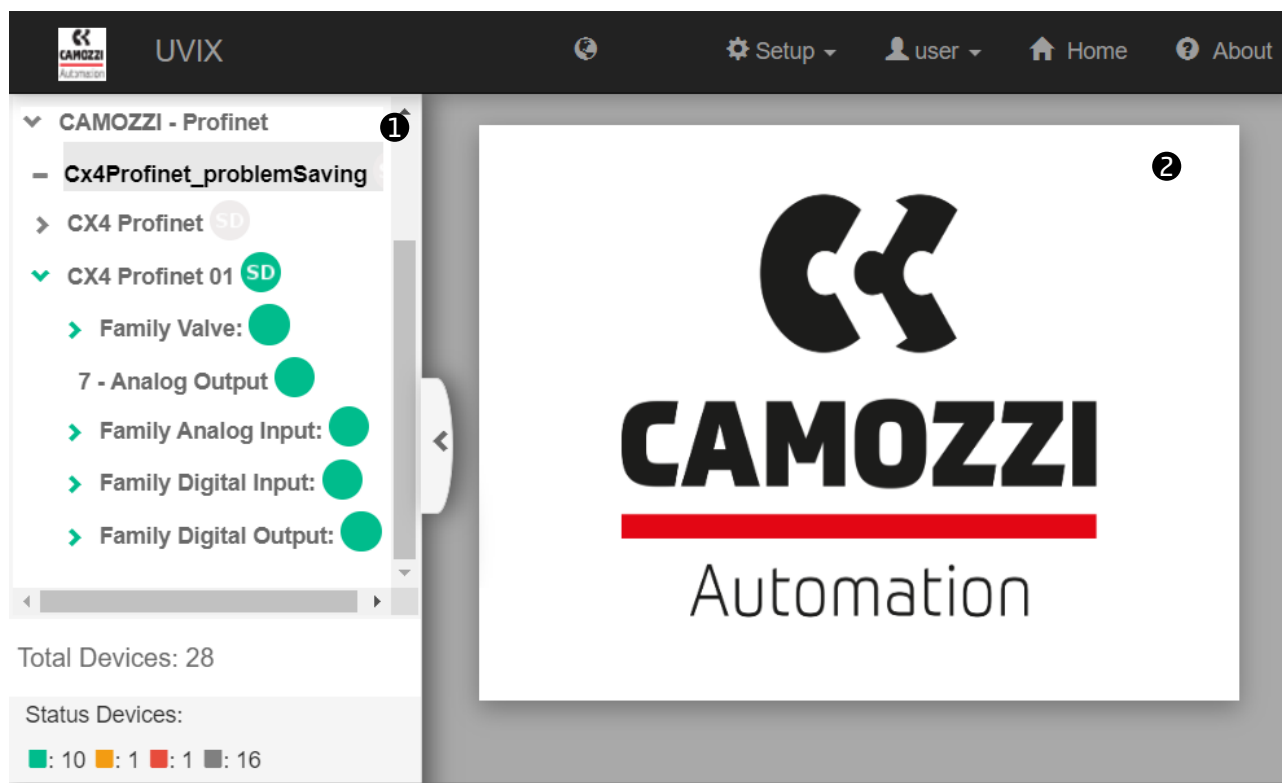



### 9.2.1 Status information

Select a Series CX4 module to view the main information.

- ① Series CX4 identification image..
- ② Device name, assigned when recognized and added in UVIX.
- ③ Device identification number (17 characters).
- ④ Device family name: *Series CX4*.
- ⑤ Type of *Series D Fieldbus* according to the connected accessory modules:
  - *Stand-Alone*, with only I/O modules connected.
  - *D1* with at least one Series D1 solenoid valve connected.
  - *D2* with at least one Series D2 solenoid valve connected.
  - *D4* with at least one Series D4 solenoid valve connected.
  - *D5* with at least one Series D1 and one Series D2 solenoid connected.
- ⑥ Firmware version.
- ⑦ Date and time of the last transmission between CX4 module and UVIX.
- ⑧ General status of the module: ● *Not available*, ● *Ok*, ● *Alarm*.
- ⑨ Stato operativo del modulo:
  - *Init* → initialization of the CX4 module and accessory modules.
  - *Enumeration* → numbering of the accessory modules connected to the CX4 module (required if modules are replaced or moved with respect to the original configuration).
  - *Mapping* → mapping of the accessory modules connected to the CX module (required to check that there have been no changes since the last system configuration).
  - *Work* → normal operation.
  - *Manual* → manual operation.
  - *Configuration* → configuration of the parameters of the CX4 module and the accessory modules.
  - *Fatal error* → fatal error that renders the CX4 module inoperative.
- ⑩ WiFi connection status: ● *Online*, ● *Offline*.
- ⑪ Fieldbus used by the module: PROFINET/IO.
- ⑫ Fieldbus communication status: ● *Online*, ● *Offline*.
- ⑬ Configuration of fieldbus-related parameters.

Status information: ▼

① 	② Name: CX4 Profinet ③ Device number: 01702227754100116 ④ Family name: Series CX4 ⑤ Subtype: Series D Fieldbus - D1 ⑥ Firmware: 2.26	⑦ Last data transmission: 2022-07-28 15:16:35 ⑧ Device status: <span style="color: green;">●</span> ⑨ Operational status: Manual ⑩ Connection: <span style="color: green;">●</span>
⑪ FieldBus: ProfiNet      ⑫ Link status: <span style="color: green;">●</span>		⑬ Configuration: 

### 9.2.2 PROFINET/IO network configuration

From the status information page, you can access the window for configuring certain fieldbus parameters <sup>13</sup>. In the specific case of PROFINET/IO, you can configure the unique network name <sup>14</sup>, the IP address <sup>15</sup>, the mask <sup>16</sup> and the gateway <sup>17</sup> of the address (par. 7.4).

Using the buttons in the bottom bar of the configuration window <sup>18</sup>, the configured parameters can be sent to the module, saved on the PC, saved on the device, or reset to default values.

Configuration
⌵ ⌵

🖥️

📡

Devices group: Camozzi
Device name: Series D fieldbus

#### Setup FieldBus: ProfiNet

**Station name [min:1 ] :** 2022-08-05 15:31:48

14

**Internet protocol address :** 2022-08-05 15:31:48

16

**Mask :** 2022-08-05 15:31:48

15

**Gateway :** 2022-08-05 15:31:48

17

Reset

18

Save on PC

Send

Save on device

### 9.2.3 Variables

The first tab of the details page deals shows the variables that are monitored by the CX4 module.

- ❶ Internal temperature of the module.
- ❷ Power voltage that supplies the subbases of the solenoid valves: the measurement is made by the first subbase connected (position 1) and is sent via serial communication. If there are no valves connected, this voltage is not displayed.
- ❸ Logic voltage that powers the module circuit board. Without this supply voltage, the entire system is without power and, therefore, turned off.

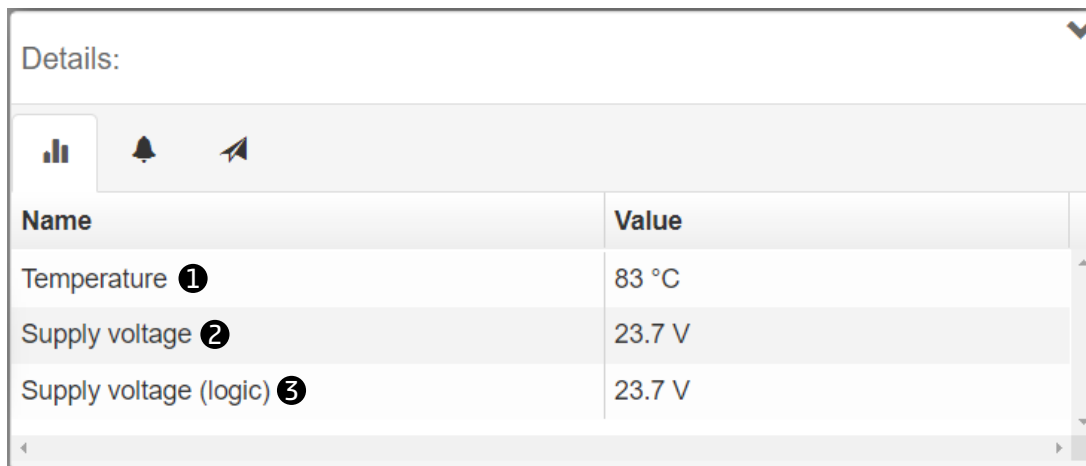

The screenshot shows a 'Details' window with a table of monitored variables. The table has two columns: 'Name' and 'Value'. The variables listed are Temperature (83 °C), Supply voltage (23.7 V), and Supply voltage (logic) (23.7 V). The table is part of a larger interface that includes a bar chart icon, a bell icon, and a share icon.



Name	Value
Temperature ❶	83 °C
Supply voltage ❷	23.7 V
Supply voltage (logic) ❸	23.7 V

### 9.2.4 Alarms

The second tab on the details page displays possible CX4 module alarms.

- **4** No mapping: indicates that there are no accessory modules connected to the CX4 module.
- **5** Valve mapping error: this can occur if the positions of the subbases of the solenoid valves have been changed, moving them from their original position or adding new ones, or if a subbase fails to respond to the mapping request from the CX4 module.
- **6** CX4 module overheating.
- **7** Supply voltage of the CX4 module lower than the voltage given in the specifications.
- **8** I/O module mapping error: this can occur if the positions of the I/O modules have been changed, moving them from their original position or adding new ones, or if an I/O module fails to respond to the mapping request from the CX4 module.
- **9** Fatal error on fieldbus: this occurs if the fieldbus protocol stack is incorrect.
- **10** Configuration error
- **11** No valve mapping: indicates that there are no solenoid valve subbases connected to the CX4 module.
- **12** No I/O module mapping: indicates that there are no I/O modules connected to the CX4 module.

Details: ▼





Event Name	Status ▼	Event Onset
Mapping absent <b>4</b>	!	
Mapping valves error <b>5</b>	!	
Overheating CX4 module <b>6</b>	!	
Undervoltage CX4 module <b>7</b>	!	
Mapping I/O modules error <b>8</b>	!	
Fieldbus fatal error <b>9</b>	!	
Configuration error <b>10</b>	⚠	
Valves absent <b>11</b>	i	
I/O modules absent <b>12</b>	i	

### 9.2.5 Commands

The third tab of details on the CX4 module shows the commands that can be sent via UVIX to the device. The *Manual Mode* command <sup>13</sup> allows you to control the system manually from UVIX, sending configuration parameters to the CX4 module and to the individual connected accessory modules. In manual mode, you can command the modules that include outputs (if present), such as the solenoid valves <sup>14</sup> (par. 9.3.6), digital outputs <sup>15</sup> (par. 9.5.5) and analogue outputs <sup>16</sup> (par. 9.7.5). The history of the commands sent to the CX4 module from when communication with UVIX was started can be viewed under *Last Commands* <sup>17</sup>.

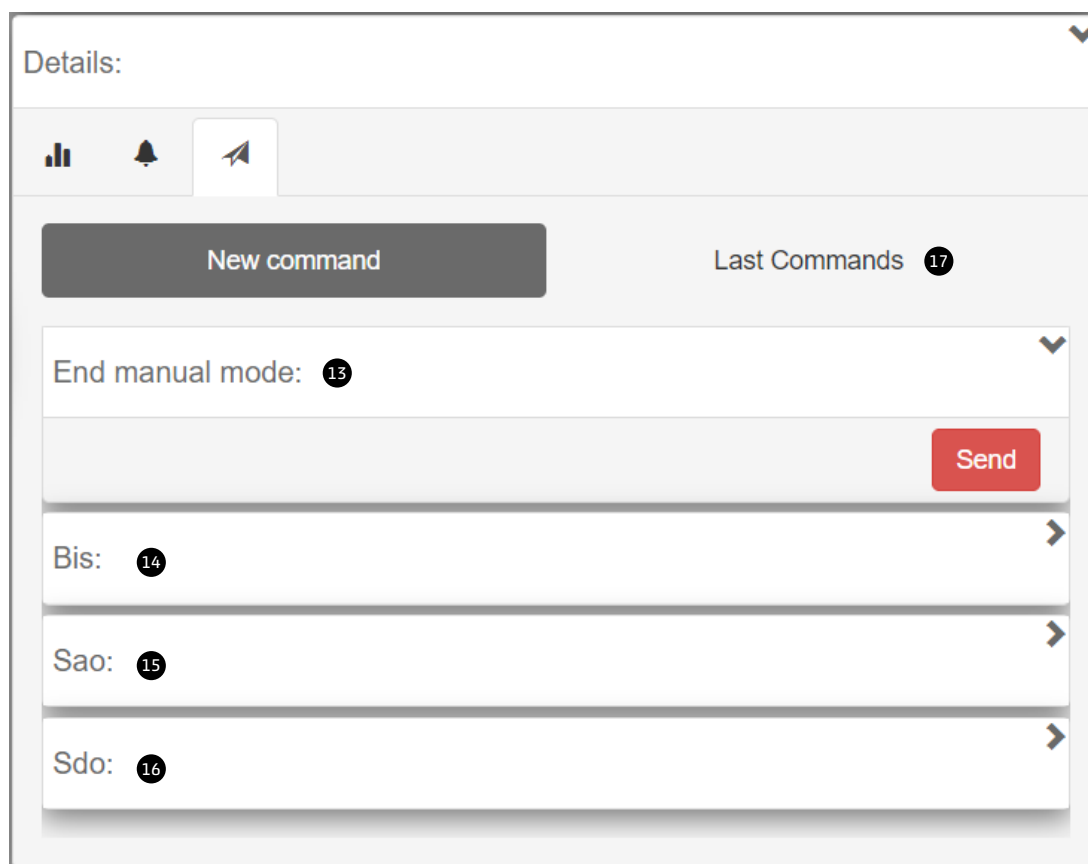
**NOTE.** If there are solenoid valve subbases connected to the CX4 module, the valve information can be reset at any time, without activating manual mode.



## 9.3 Series D coil valves and subbase

### 9.3.1 Status information

On the first page of UVIX, you can select one of the solenoid valves connected to the CX4 module in the configuration of a Series D valve island to view the general information of the individual subbase.

- ❶ Identification images of the coil valve mounted on the subbase.
- ❷ Position of the subbase in the assigned valve island after mapping.
- ❸ Name of the accessory module family: *Valve*.
- ❹ Solenoid valve family sub-type: 10 mm, 16 mm, 25 mm.
- ❺ Firmware version.
- ❻ Date and time of the last transmission of the variables between the subbase and UVIX.
- ❼ General status of the solenoid valve: ● *Not available*, ● *Ok*, ● *Alarm*.
- ❽ Operating status of the subbase:
  - *Init* → initialization (mapping and configuration of parameters).
  - *Work* → normal operation.
  - *Error* → subbase error.

Status information: ▼

	<p>❷ Position: 1</p> <p>❸ Family name: Valve</p> <p>❹ Subtype: 10 mm</p> <p>❺ Firmware: 2.11</p>	<p>❻ Last data transmission: 2022-09-21 09:45:04</p> <p>❼ Status: <span style="color: green;">●</span></p> <p>❽ Operational status: Work</p>
---	--	--

❾ ⚙ Configuration



### 9.3.2 Configuration

From the status information page, you can configure certain operating-related parameters of the solenoid valves **9**.

- **10** Enable/disable the alarms that the valve can generate (default: all alarms enabled).
- **11** Enable/disable the Failsafe for each individual pilot: *Yes* enabled, *No* disabled (default).
- **12** Set the Failsafe status for each pilot for which the Failsafe has been enabled: *On* pilot activated, *Off* pilot deactivated (default).
- **13** Set the behaviour of the valve failure error (Coil Fault): *Latched*, *Not Latched* (default).
- **14** The buttons in the bottom bar of the tab allow you to send the configuration parameters to the module, save them on the PC, save them on the device or reset them to default values.

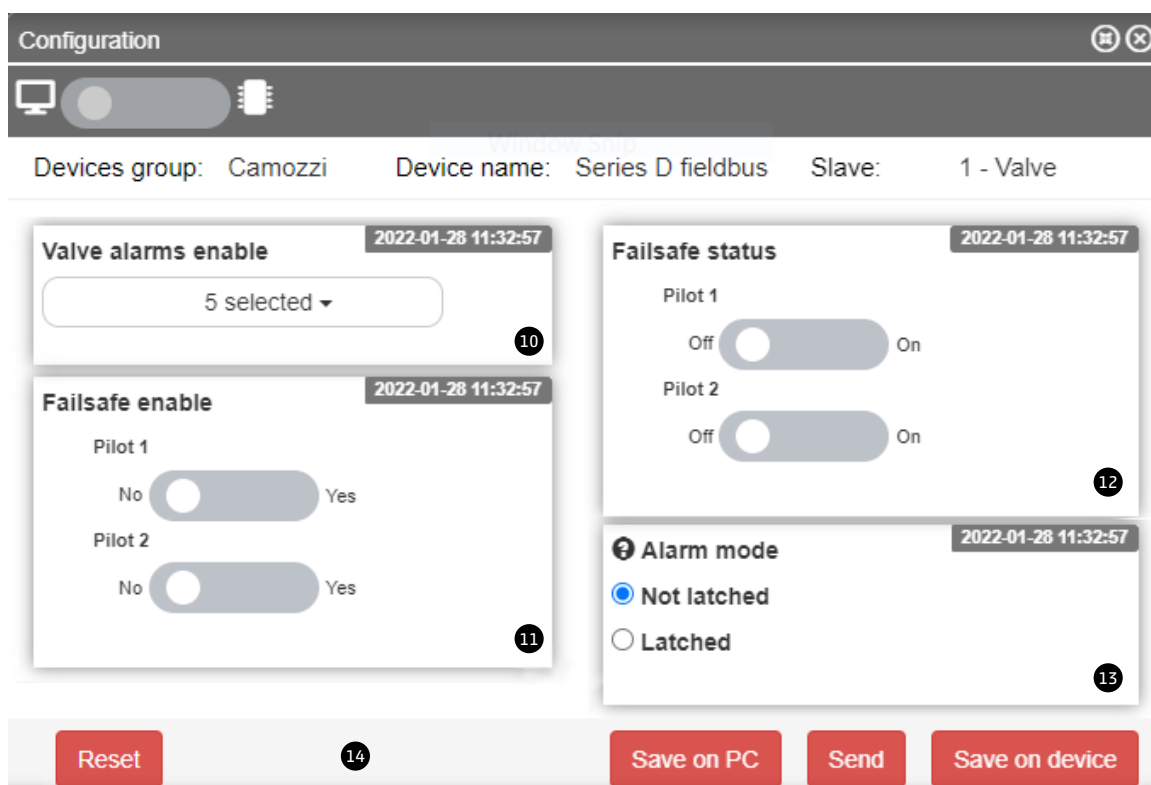

### 9.3.3 Details

### 9.3.4 Variables

The first tab on the details page shows the variables that are monitored by the subbase of an individual solenoid valve. These variables can be reset using the commands by selecting the CX4 module to which the subbases are connected (par. 9.3.6).

- ❶ subbase temperature.
- ❷ Cycles performed by the pilots in position 14 and position 12.
- ❸ Percentage health status of the pilots in position 14 and position 12.
- ❹ Status of the pilots in position 14 and position 12 (*On/Off*).
- ❺ Temperature of the pilots in position 14 and position 12.
- ❻ Errors of the pilots in position 14 and position 12.
- ❼ Communication errors between the CX4 module and the selected subbase.
- ❽ Gauge indicators that show graphically the percentage health status of the two pilots.

Details: ▼

📊 Variables
🔔 Alarms

Name	Value
Temperature subbase ❶	31 °C
Cycles coil 14 ❷	3799203
Cycles coil 12	3798813
Health status coil 14 ❸	100 %
Health status coil 12	100 %
Status coil 14 ❹	Off
Status coil 12	Off
Temperature coil 14 ❺	33 °C
Temperature coil 12	37 °C
Errors coil 14 ❻	0
Errors coil 12	0
Communication retries ❼	228

Health status coil 14 [ % ]

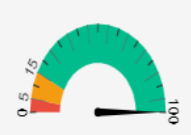

Health status coil 12 [ % ]

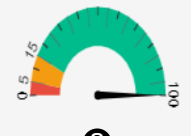

❽

### 9.3.5 Alarms

The second details tab displays the alarms of the subbase of the selected valve.

- 8 Communication alarm due to communication failure between CX4 module and subbase.
- 9 subbase overheating.
- 10 Overheating of the pilots in position 14 and position 12.
- 11 Overcurrent of the pilots in position 14 and position 12.
- 12 Alarm - solenoid valves closed in position 14 and position 12.
- 13 Energization malfunction of the solenoid pilots in position 14 and position 12.
- 14 Alarm - configuration of subbase parameters.
- 15 Replace valve warning.

Details: ▼

▬ Variables

🔔 Alarms

Event Name	Status ▼	Event Onset
Communication alarm 8	!	
Overheating subbase 9	!	
Overheating coil 14	!	
Overheating coil 12 10	!	
Overcurrent coil 14	!	
Overcurrent coil 12 11	!	
Interrupted coil 14	!	
Interrupted coil 12 12	!	
Fault coil 14	!	
Fault coil 12 13	!	
Configuration alarm 14	⚠	
Valve substitution 15	⚠	

### 9.3.6 Commands

On the main page of the CX4 module (par. 9.2.5), there is a tab showing the commands for the solenoid valves. In particular, you can reset the valve information <sup>16</sup> (cycles, errors, health status). This operation needs to be performed when the valve connected to the subbase is replaced and can also be performed in normal working mode.

You can also control the individual pilots (position 12 and 14) of the solenoid valves <sup>17</sup>. For this operation, the island must be in manual mode.

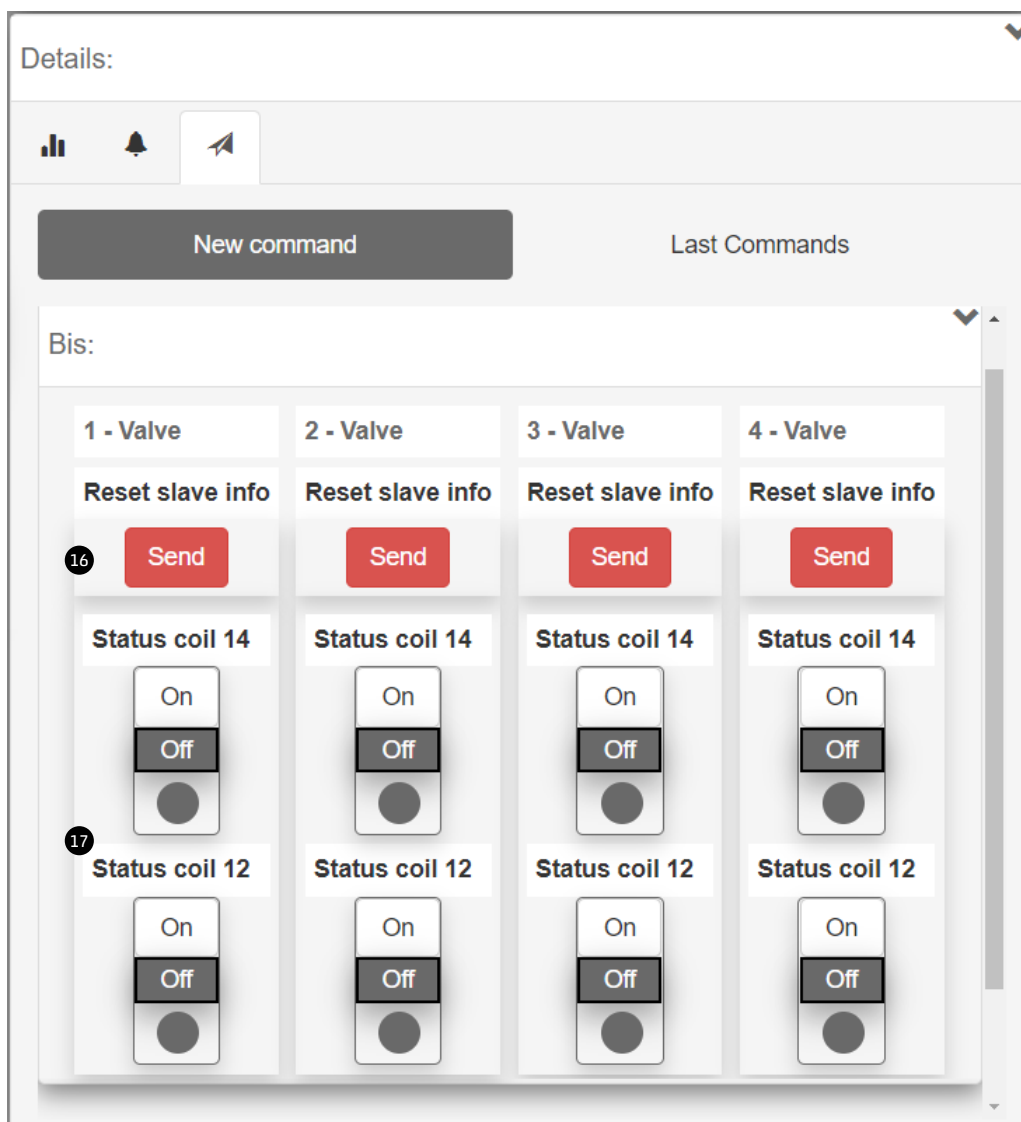



## 9.4 Digital Input Module

### 9.4.1 Status information

On the first page of UVIX, select one of the digital inputs connected to the CX4 module to view the general information of the accessory module.

- Identification images of the digital input module (8 or 16 channels).
- Module position assigned after mapping.
- Name of the accessory module family: *Digital Input*.
- Subtype of the family of the digital input module: 8 CH, 16 CH.
- Firmware version.
- Date and time of the last transmission of the variables between the module and UVIX.
- General status of the module: ● *Not available*, ● *Ok*, ● *Alarm*.
- Operating status of the module:
  - *Init* → initialization (mapping and configuration of parameters).
  - *Work* → normal operation.
  - *Error* → module error.

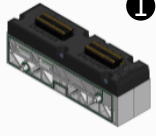
Status information: ▼

<b>1</b>		<b>2</b>	Position: 12	<b>6</b>	Last data transmission: 2022-09-21 09:40:57
<b>3</b>	Family name: Digital Input	<b>7</b>	Status: <span style="color: green;">●</span>	<b>8</b>	Operational status: Work
<b>4</b>	Subtype: 16 CH	<b>5</b>	Firmware: 1.11		
<b>9</b>	 Configuration				

### 9.4.2 Configuration

From the status information page, you can configure certain operating-related parameters of the digital input modules 9.

- 10 Parameter for the polarity of each channel, *High* or *Low* (default).
- 11 Minimum input level activation time in milliseconds (filtro *anti-bounce*, default: 0).
- 12 Minimum input rereading time in milliseconds (default: 0).
- 13 Using the buttons in the bottom bar of the configuration window, the configured parameters can be sent to the module, saved on the PC, saved on the device or reset to default values.

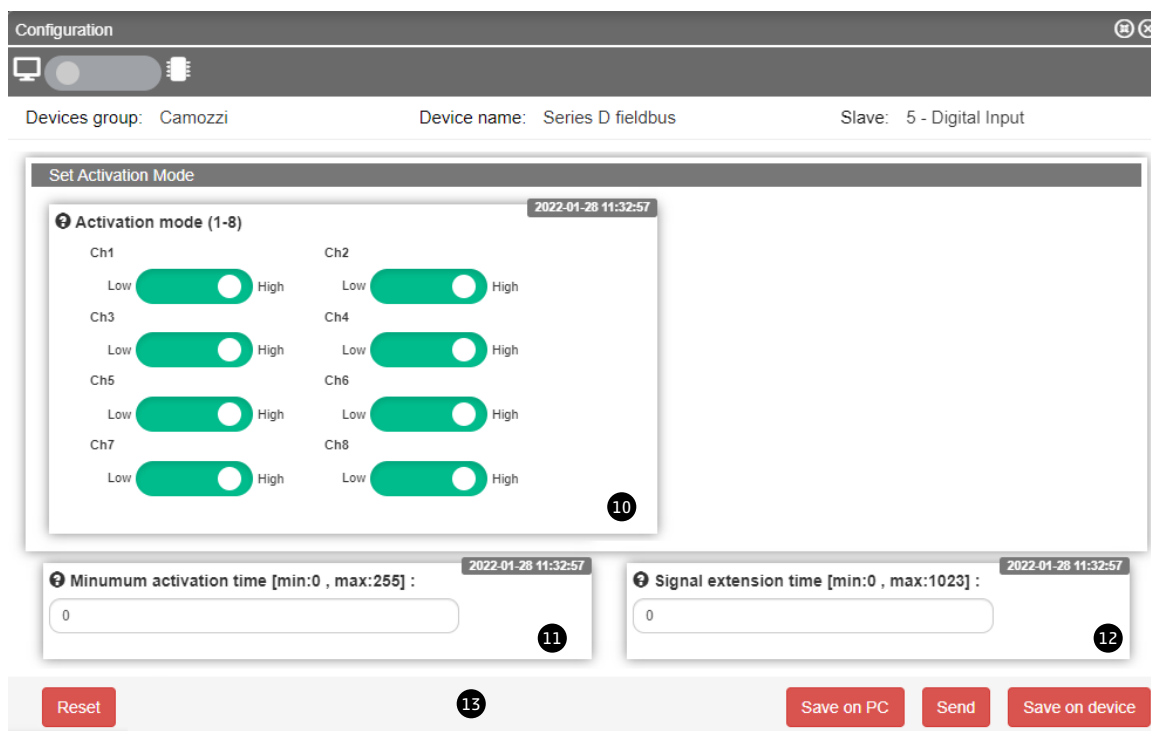

### 9.4.3 Variables

The first tab on the details page displays the status of the digital inputs ①: ● active, ○ not active.

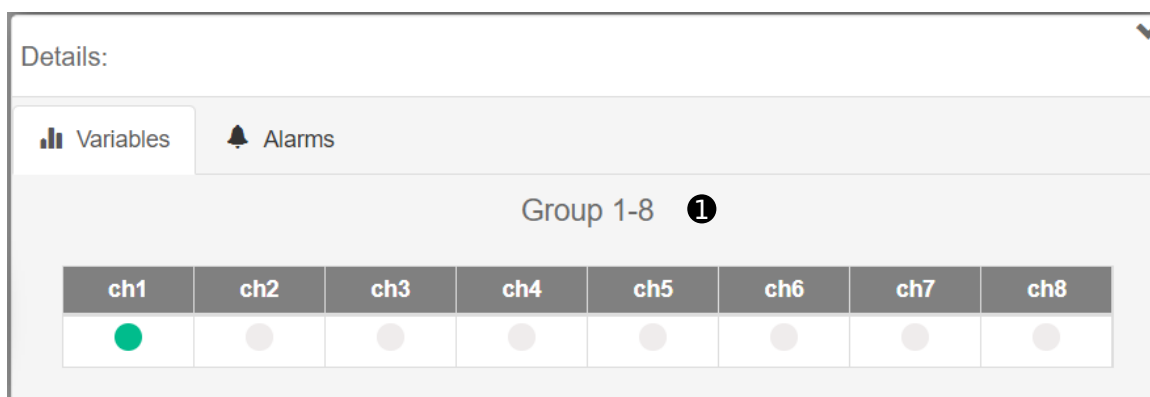

### 9.4.4 alarms

The second details tab displays the alarms of the digital input module.

- ② Communication alarm between the digital input module and the CX4 module.
- ③ Configuration alarm of module parameters.
- ④ Short-circuit of at least one digital input belonging to an input group. This alarm can be divided into two groups for modules with 8 channels or into four groups for modules with 16 channels.

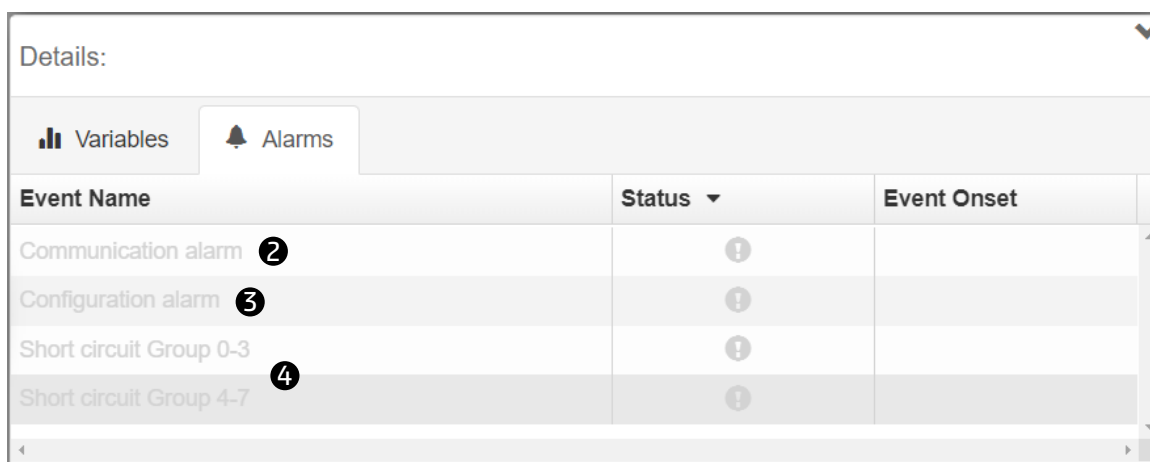

Event Name	Status	Event Onset
Communication alarm ②	!	
Configuration alarm ③	!	
Short circuit Group 0-3	!	
Short circuit Group 4-7 ④	!	



### 9.5 Digital Output Module

#### 9.5.1 Status information

On the first page of UVIX, select one of the digital outputs connected to the CX4 module to view the general information of the accessory module.

- Identification images of the digital output module (8 or 16 channels).
- Module position assigned after mapping.
- Name of the accessory module family: *Digital Output*.
- Subtype of the family of the digital output module: 8 CH, 16 CH.
- Firmware version.
- Date and time of the last transmission of the variables between the module and UVIX.
- General status of the module: ● *Not available*, ● *Ok*, ● *Alarm*.
- Operating status of the module:
  - *Init* → initialization (mapping and configuration of parameters).
  - *Work* → normal operation.
  - *Error* → module error.

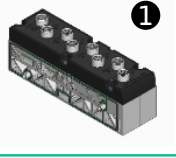
Status information: ▼

<b>1</b>		<b>2</b>	Position: 14	<b>6</b>	Last data transmission: 2022-09-21 09:43:00
<b>3</b>	Family name: Digital Output	<b>7</b>	Status: <span style="color: green;">●</span>	<b>8</b>	Operational status: Work
<b>4</b>	Subtype: 8 CH	<b>5</b>	Firmware: 1.10		
<b>9</b>	 Configuration				

#### 9.5.2 Configuration

From the status information page, you can configure certain operating-related parameters of the digital output modules **9**.

- **10** Enable output: *No disabled*, *Yes enabled* (default).
- **11** Set the type of individual output channel: *type N*, *type P* (default).
- **12** Enable the individual functions related to the whole module, see the detection of no load by the power driver.
- **13** Set the PWM for individual outputs: *Yes enabled*, *No disabled* (default).
- **14** Enable the protection failsafe, which can be set for the individual outputs: *Yes enabled*, *No disabled* (default).
- **15** Failsafe status, which can be set for the individual outputs: *On*, *Off* (default).
- **16** Using the buttons in the bottom bar of the configuration window, the configured parameters can be sent to the module, saved on the PC, saved on the device or reset to default values.



## Chapter 9 Uvix

Configuration
⊕ ⊗

🖥️
🔌

Devices group: Camozzi      Device name: Series D fieldbus      Slave: 6 - Digital Output

Set enable out channel
2022-01-28 11:32:57

**Enable channels (1-8)**

Channel 1 No <input checked="" type="checkbox"/> Yes	Channel 2 No <input checked="" type="checkbox"/> Yes	Channel 3 No <input checked="" type="checkbox"/> Yes	Channel 4 No <input checked="" type="checkbox"/> Yes
Channel 5 No <input checked="" type="checkbox"/> Yes	Channel 6 No <input checked="" type="checkbox"/> Yes	Channel 7 No <input checked="" type="checkbox"/> Yes	Channel 8 No <input checked="" type="checkbox"/> Yes

10

Set type out channel
2022-01-28 11:32:57

**Channel Type (1-8)**

Channel 1 N <input checked="" type="checkbox"/> P	Channel 2 N <input checked="" type="checkbox"/> P	Channel 3 N <input checked="" type="checkbox"/> P	Channel 4 N <input checked="" type="checkbox"/> P
Channel 5 N <input checked="" type="checkbox"/> P	Channel 6 N <input checked="" type="checkbox"/> P	Channel 7 N <input checked="" type="checkbox"/> P	Channel 8 N <input checked="" type="checkbox"/> P

11

Module Settings
2022-01-28 11:32:57

Enable alarm n.c.  
No  Yes

12

Set enable PWM
2022-01-28 11:32:57

**Enable PWM (1-8)**

Channel 1 No <input type="checkbox"/> Yes	Channel 2 No <input type="checkbox"/> Yes	Channel 3 No <input type="checkbox"/> Yes	Channel 4 No <input type="checkbox"/> Yes
Channel 5 No <input type="checkbox"/> Yes	Channel 6 No <input type="checkbox"/> Yes	Channel 7 No <input type="checkbox"/> Yes	Channel 8 No <input type="checkbox"/> Yes

13

Set enable failsafe channel
2022-01-28 11:32:57

**Enable failsafe (1-8)**

Channel 1 No <input checked="" type="checkbox"/> Yes	Channel 2 No <input type="checkbox"/> Yes	Channel 3 No <input type="checkbox"/> Yes	Channel 4 No <input type="checkbox"/> Yes
Channel 5 No <input type="checkbox"/> Yes	Channel 6 No <input type="checkbox"/> Yes	Channel 7 No <input type="checkbox"/> Yes	Channel 8 No <input type="checkbox"/> Yes

14

Set state failsafe channel
2022-01-28 11:32:57

**Failsafe state (1-8)**

Channel 1 Off <input type="checkbox"/> On	Channel 2 Off <input type="checkbox"/> On	Channel 3 Off <input type="checkbox"/> On	Channel 4 Off <input type="checkbox"/> On
Channel 5 Off <input type="checkbox"/> On	Channel 6 Off <input type="checkbox"/> On	Channel 7 Off <input type="checkbox"/> On	Channel 8 Off <input type="checkbox"/> On

15

Reset
16
Save on PC
Send
Save on device

### 9.5.3 Variables

The first tab on the details page displays the status of the digital outputs ①: ● attiva, ● non attiva.

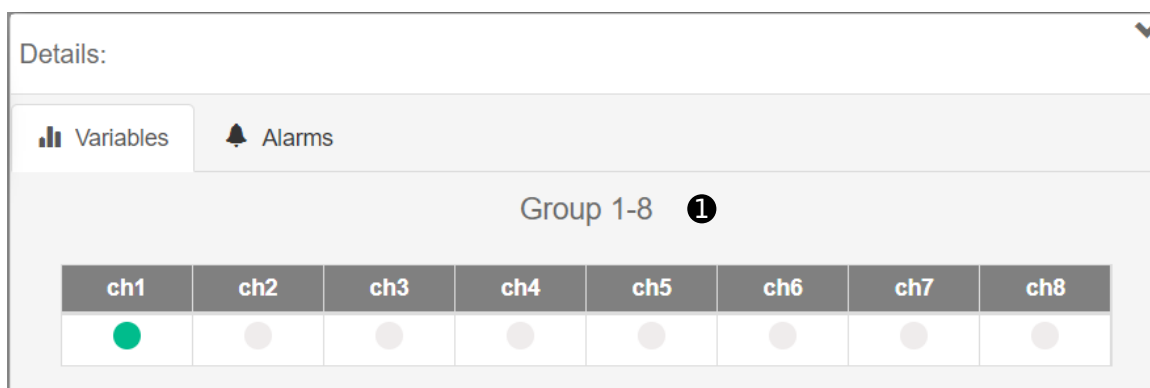



### 9.5.4 Allarmi

The second details tab displays the alarms of the digital output module.

- **2** Communication alarm between the digital input module and the CX4 module.
- **3** Configuration alarm of module parameters.
- **4** No external power supply, required to power the digital outputs.
- **5** The supply voltage is less than 4.5V.
- **6** Circuit open on an output channel.
- **7** Short circuit on an output channel.

Details: ▼

 Variables
 Alarms

Event Name	Status ▼	Event Onset
Communication alarm <b>2</b>	!	
Configuration alarm <b>3</b>	!	
Zero Voltage Power Supply <b>4</b>	!	
Under Voltage Power Supply <b>5</b>	!	
Open Load Channel 1	!	
Open Load Channel 2	!	
Open Load Channel 3	!	
Open Load Channel 4	!	
Open Load Channel 5 <b>6</b>	!	
Open Load Channel 6	!	
Open Load Channel 7	!	
Open Load Channel 8	!	
Short Circuit Channel 1	!	
Short Circuit Channel 2	!	
Short Circuit Channel 3	!	
Short Circuit Channel 4	!	
Short Circuit Channel 5 <b>7</b>	!	
Short Circuit Channel 6	!	
Short Circuit Channel 7	!	
Short Circuit Channel 8	!	

### 9.5.5 Comands

On the main page of the CX4 module (par. 9.2.5) there is a tab showing the commands to pilot the individual channels of the digital outputs **8**. This tab is only visible in manual mode and if it has at least one digital output module. digitali.

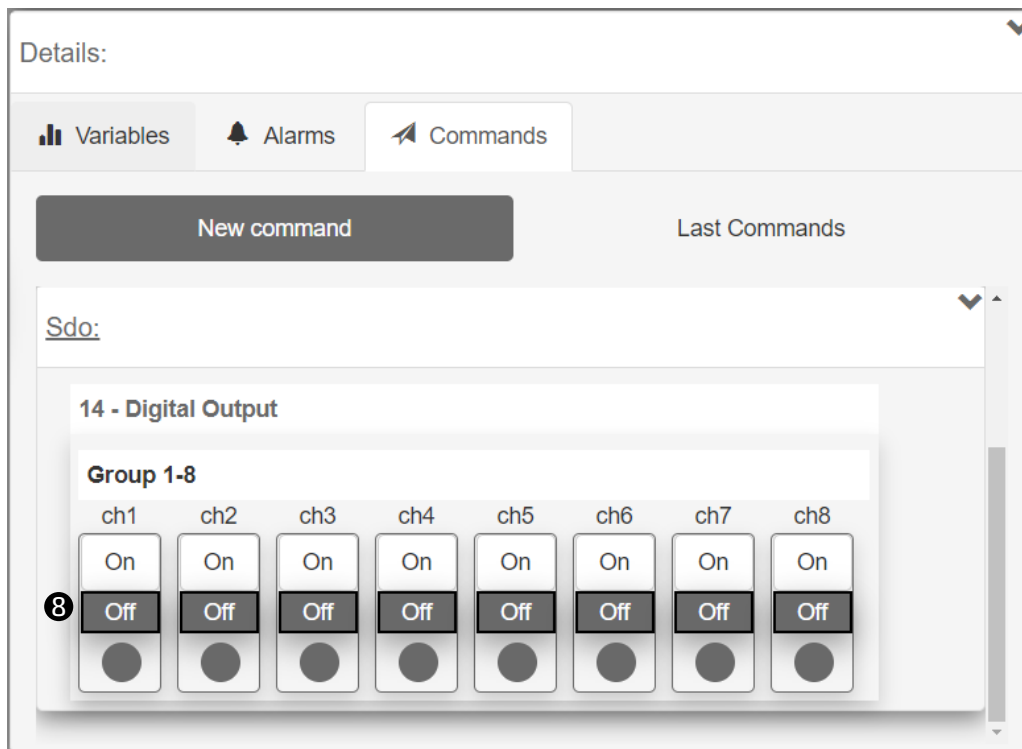

### 9.6 Analogue Input Module

#### 9.6.1 Status information

On the first page of UVIX, select one of the analogue inputs connected to the CX4 module to view the general information of the accessory module.

- Identification images of the analogue input module.
- Module position assigned after mapping.
- Name of the accessory module family: *Analog Input*.
- Subtype of the family of the analogue input module: *RTD, Thermocouple, Bridge, Voltage/Current*.
- Firmware version.
- Date and time of the last transmission of the variables between the module and UVIX.
- General status of the module: ● *Not available*, ● *Ok*, ● *Alarm*.
- Operating status of the module:
  - *Init* → initialization (mapping and configuration of parameters).
  - *Work* → normal operation.
  - *Error* → module error.

Status information: ▼

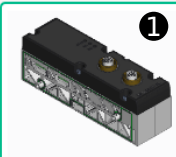
	<p>② Position: 8</p> <p>③ Family name: Analog Input</p> <p>④ Subtype: RTD</p> <p>⑤ Firmware: 1.07</p>	<p>⑥ Last data transmission: 2022-09-21 08:59:51</p> <p>⑦ Status: <span style="color: green;">●</span></p> <p>⑧ Operational status: Work</p>
<p>⑨  Configuration</p>		

#### 9.6.2 Configuration

From the status information page, you can configure certain operating-related parameters of the analogue input modules ⑨.

Some of these parameters are specific to individual subtypes, while others are common to all subtypes of the analogue input family.

- ⑩ Enable threshold-based transmission (default: *Disable*).
- ⑪ Enable frequency-based transmission (default: *Disable*).
- ⑫ Length of the impulse response of the FIR filter on channel 1 and channel 2.
- ⑬ Using the buttons in the bottom bar of the configuration window, the configured parameters can be sent to the module, saved on the PC, saved on the device or reset to default values.
- ⑭ Type of RTD for channel 1 and for channel 2.
- ⑮ Number of wires for the RTD sensor on channel 1 and channel 1.
- ⑯ Type of Thermocouple for channel 1 and for channel 2.
- ⑰ Type of Bridge for channel 1 and for channel 2.
- ⑱ Type of Voltage/Current module for channel 1 and for channel 2.

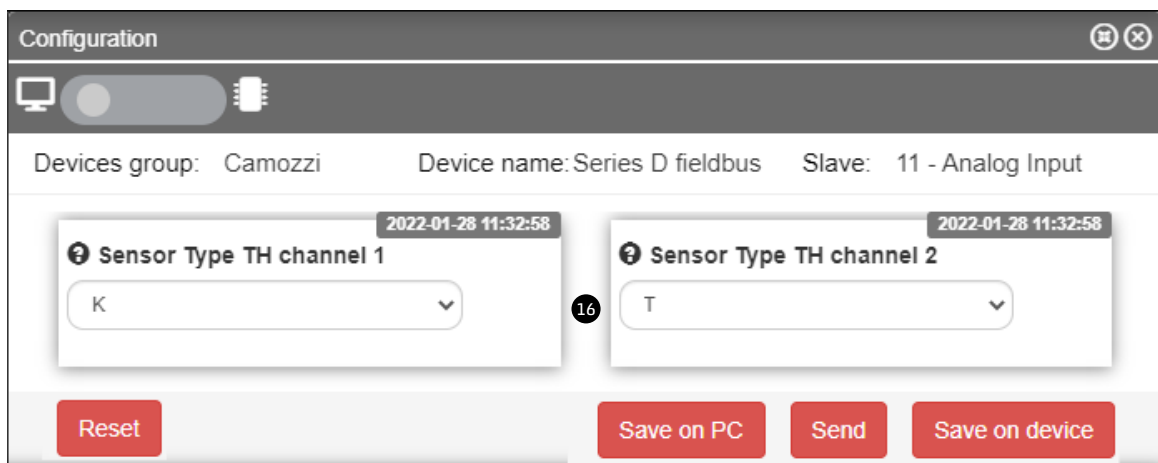
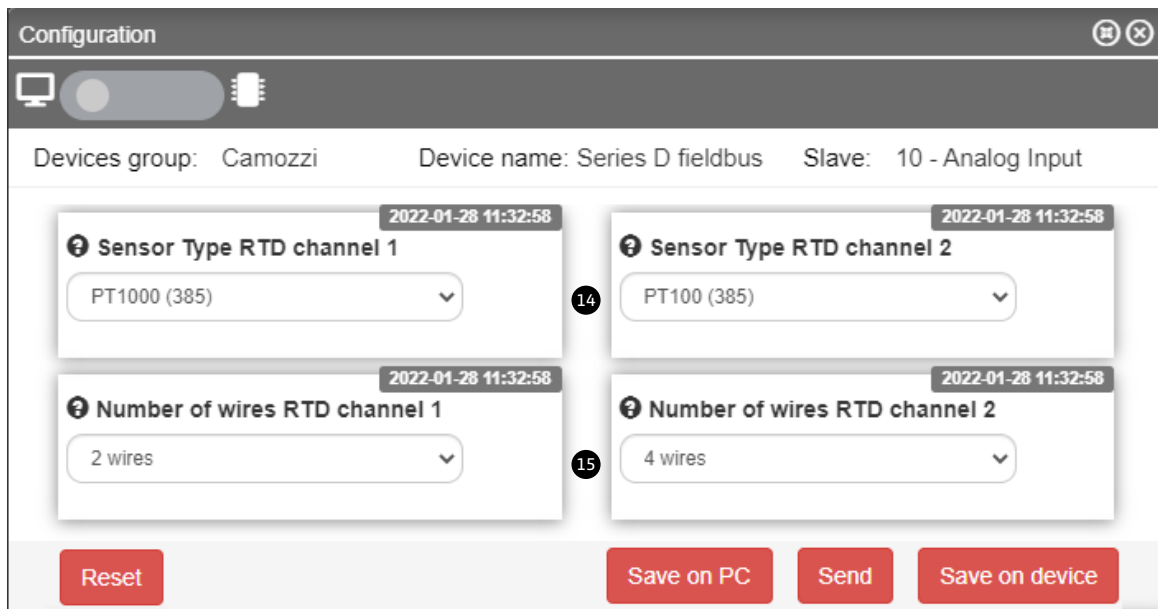
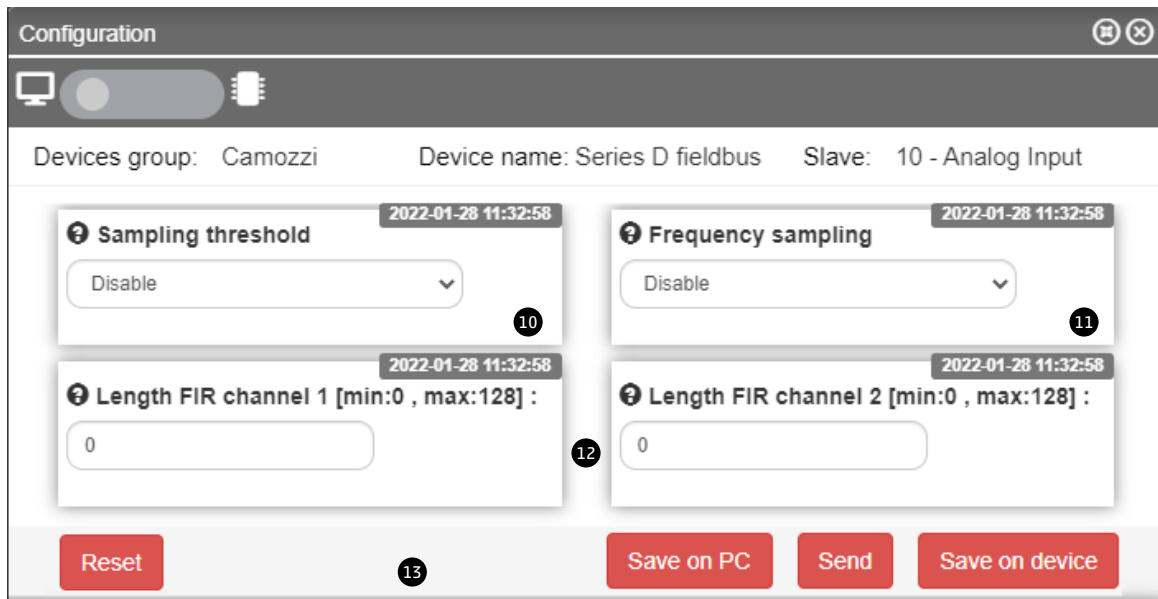

Configuration ⊞ ✕

Devices group: default group    Device name: Series D fieldbus    Slave: 3 - Analog Input

---

**Bridge factor channel 1 [min:0 , max:255] :** 2022-09-14 13:24:09

**Bridge factor channel 2 [min:0 , max:255] :** 2022-09-14 13:24:09

17

**Reset**    **Save on PC**    **Send**    **Save on device**

Configuration ⊞ ✕

Devices group: Profibus    Device name: Series D fieldbus    Slave: 9 - Analog Input

---

**Input Type channel 1** 2022-08-05 15:26:21

**Input Type channel 2** 2022-08-05 15:26:21

18

**Reset**    **Save on PC**    **Send**    **Save on device**

### 9.6.3 Variables

The first tab on the details page displays the variables monitored by the analogue input module for both channels: temperatures **1** for RTD and Thermocouples, currents or voltages **2** for Voltage/Current modules and voltages **3** for the Bridges.

Details: ▼

**Variables** Alarms

Name	Value
Temperature channel 1 <b>1</b>	28 °C
Temperature channel 2	27 °C

Details: ▼

**Variables** Alarms

Name	Value
Voltage / Current channel 1	3311.28 mV
Voltage / Current channel 2 <b>2</b>	11.11 mA

Details: ▼

**Variables** Alarms

Name	Value
Voltage channel 1 <b>3</b>	268.32 mV
Voltage channel 2	8388.61 mV



### 9.6.4 Alarms

The second details tab displays the alarms of the analogue input module.

- ④ Malfunction of the sensor connected to channel 1.
- ⑤ Bridge sensor connected to channel 1 missing or faulty (alarm for bridges only).
- ⑥ Communication error with the internal ADC converter, which measures the relevant physical quantities.
- ⑦ Error in 3.3V logic supply voltage.
- ⑧ Malfunction of the sensor connected to channel 2.
- ⑨ Bridge sensor connected to channel 2 missing or faulty (alarm for bridges only).
- ⑩ Communication alarm between the analogue input module and the CX4 module.
- ⑪ Configuration alarm during parameterization.

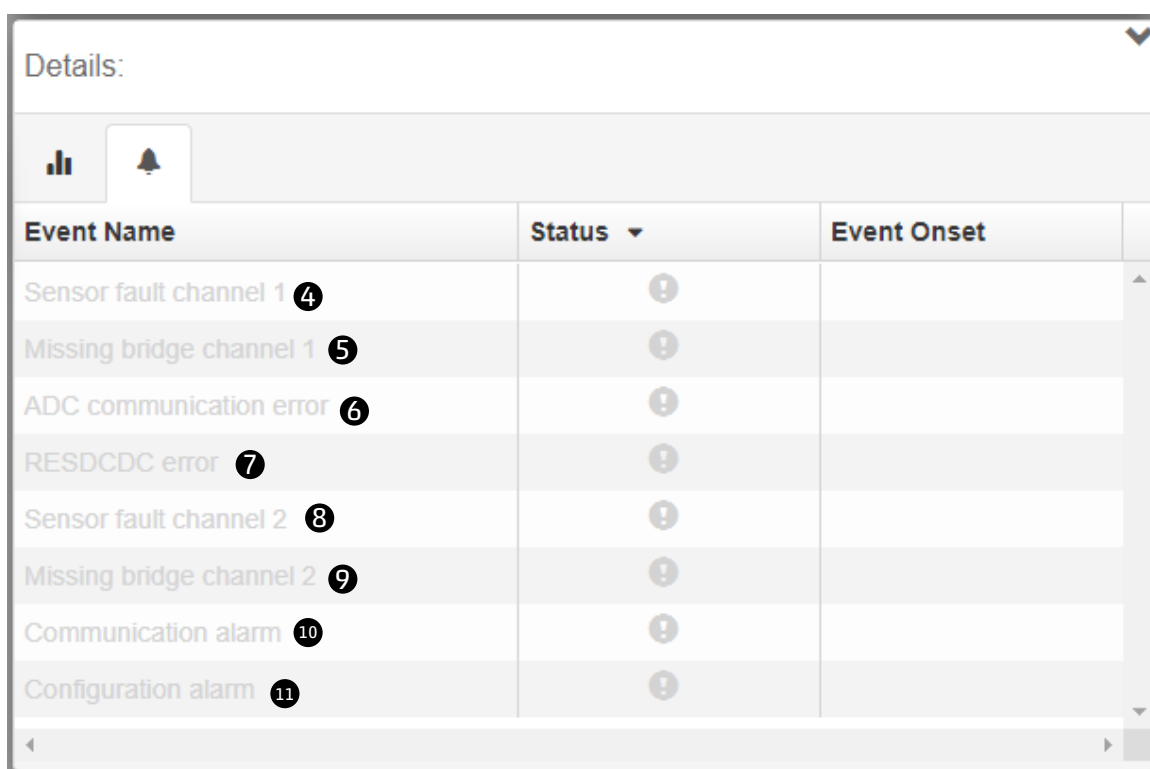

Event Name	Status	Event Onset
Sensor fault channel 1 ④	!	
Missing bridge channel 1 ⑤	!	
ADC communication error ⑥	!	
RESDCDC error ⑦	!	
Sensor fault channel 2 ⑧	!	
Missing bridge channel 2 ⑨	!	
Communication alarm ⑩	!	
Configuration alarm ⑪	!	



## 9.7 Analogue Output Module

### 9.7.1 Status information

On the first page of UVIX, select one of the analogue outputs connected to the CX4 module to view the general information of the accessory module.

- ❶ Identification images of the analogue output module.
- ❷ Module position assigned after mapping.
- ❸ Name of the accessory module family: *Analog Output*.
- ❹ Subtype of the family of the analogue output module: 2 CH.
- ❺ Firmware version.
- ❻ Date and time of the last transmission of the variables between the analogue output module and UVIX.
- ❼ General status of the module: ● *Not available*, ● *Ok*, ● *Alarm*.
- ❽ Operating status of the module:
  - *Init* → initialization (mapping and configuration of parameters).
  - *Work* → normal operation.
  - *Error* → module error.

Status information: ▼

	❷ Position: 7 ❸ Family name: Analog Output ❹ Subtype: 2 CH ❺ Firmware: 1.00	❻ Last data transmission: 2022-09-21 09:38:39 ❼ Status: <span style="color: green;">●</span> ❽ Operational status:
❾  Configuration		

### 9.7.2 Configuration

From the status information page, you can configure certain operating-related parameters of the digital output modules **9**.

- **10** Type of analogue output (voltage or current) on channel 1.
- **11** Type of analogue output (voltage or current) on channel 2.
- **12** Enable Failsafe for channel 1: *Yes* enabled, *No* disabled (default).
- **13** Enable Failsafe for channel 2: *Yes* enabled, *No* disabled (default).
- **14** Failsafe value if enabled on the corresponding channel (mV/mA).

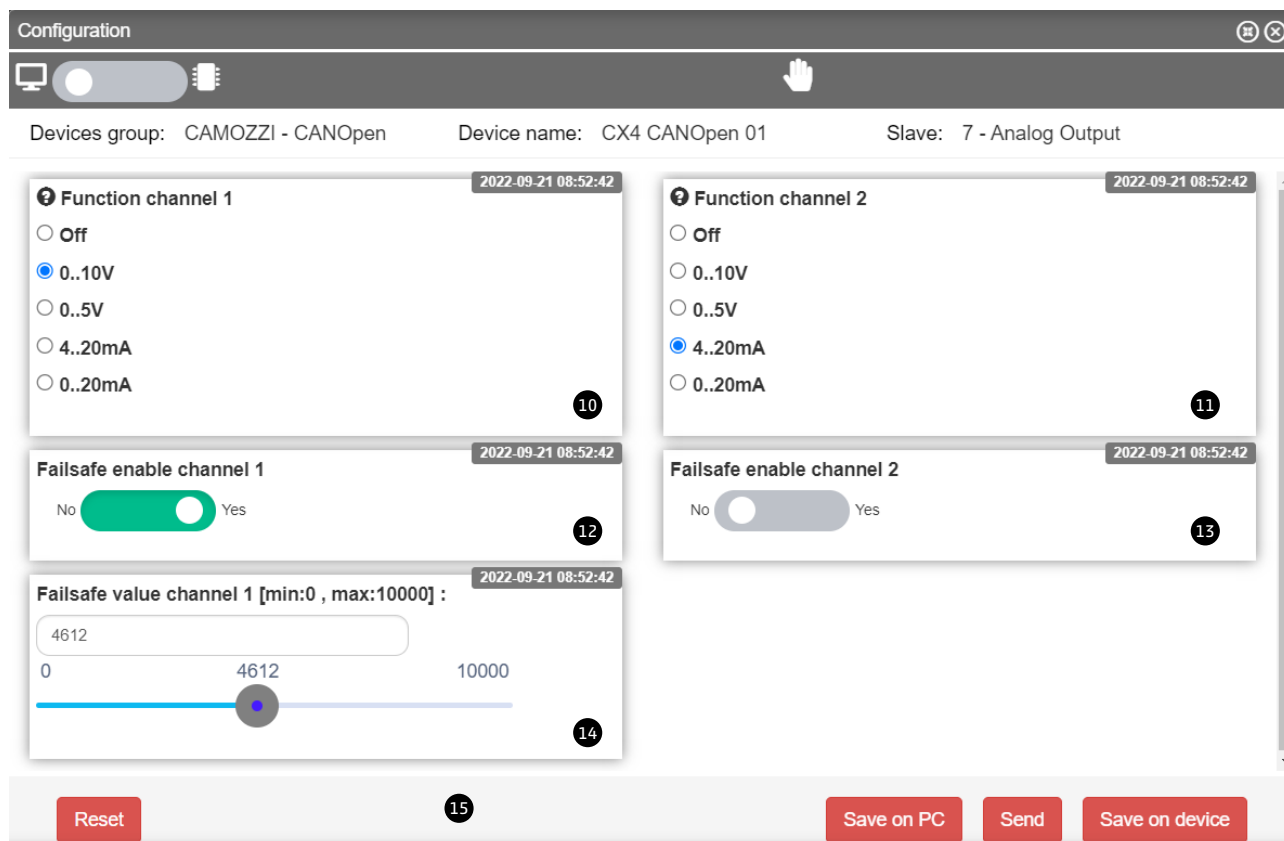

Configuration

Devices group: CAMOZZI - CANOpen    Device name: CX4 CANOpen 01    Slave: 7 - Analog Output

**Function channel 1** 2022-09-21 08:52:42

Off

0..10V

0..5V

4..20mA

0..20mA

**10**

---

**Failsafe enable channel 1** 2022-09-21 08:52:42

No  Yes

**12**

---

**Failsafe value channel 1 [min:0 , max:10000] :** 2022-09-21 08:52:42

4612

0                      4612                      10000

**14**

**Function channel 2** 2022-09-21 08:52:42

Off

0..10V

0..5V

4..20mA

0..20mA

**11**

---

**Failsafe enable channel 2** 2022-09-21 08:52:42

No  Yes

**13**

**Reset**
**15**
**Save on PC**
**Send**
**Save on device**

### 9.7.3 Variables

The first tab on the details page displays the analogue output module variables for both channels depending on how they are configured ①.

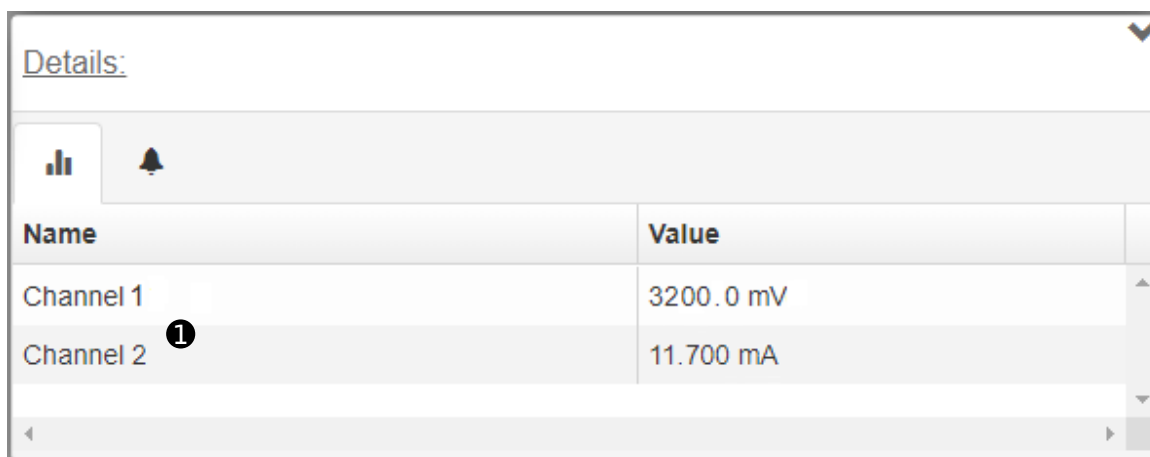

Name	Value
Channel 1	3200.0 mV
Channel 2 ①	11.700 mA

### 9.7.4 Alarms

The second tab on the details page displays the alarms of the analogue input module.

- ② Communication alarm between the analogue output module and the CX4 module.
- ③ Configuration alarm during parameterization.
- ④ Open circuit on channel 1.
- ⑤ Open circuit on channel 2.
- ⑥ Overheating of analogue output module.
- ⑦ Short circuit of module supply voltage.
- ⑧ Module supply voltage too low.
- ⑨ Internal error.

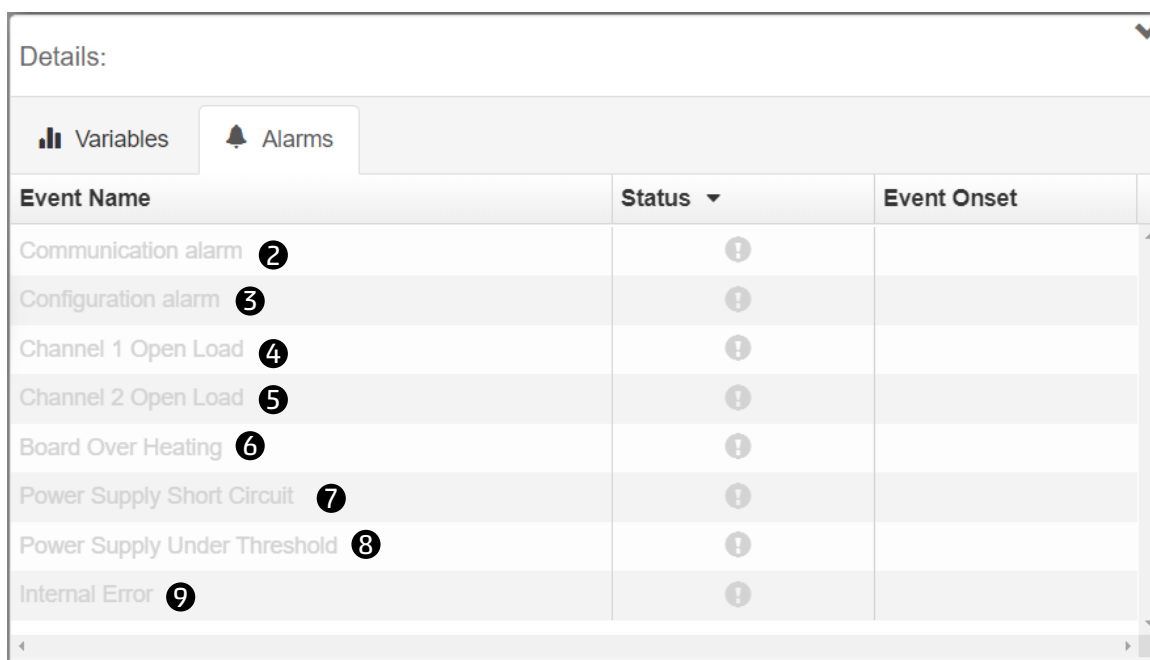

Event Name	Status	Event Onset
Communication alarm ②	!	
Configuration alarm ③	!	
Channel 1 Open Load ④	!	
Channel 2 Open Load ⑤	!	
Board Over Heating ⑥	!	
Power Supply Short Circuit ⑦	!	
Power Supply Under Threshold ⑧	!	
Internal Error ⑨	!	

### 9.7.5 Commands

On the main page of the CX4 module (par. 9.2.5), there is a tab showing the commands for piloting the analogue output channels ( 10 and 11 ) by setting the value of the output in the corresponding unit of measurement. This tab is only visible in manual mode and if it has at least one analogue output module.

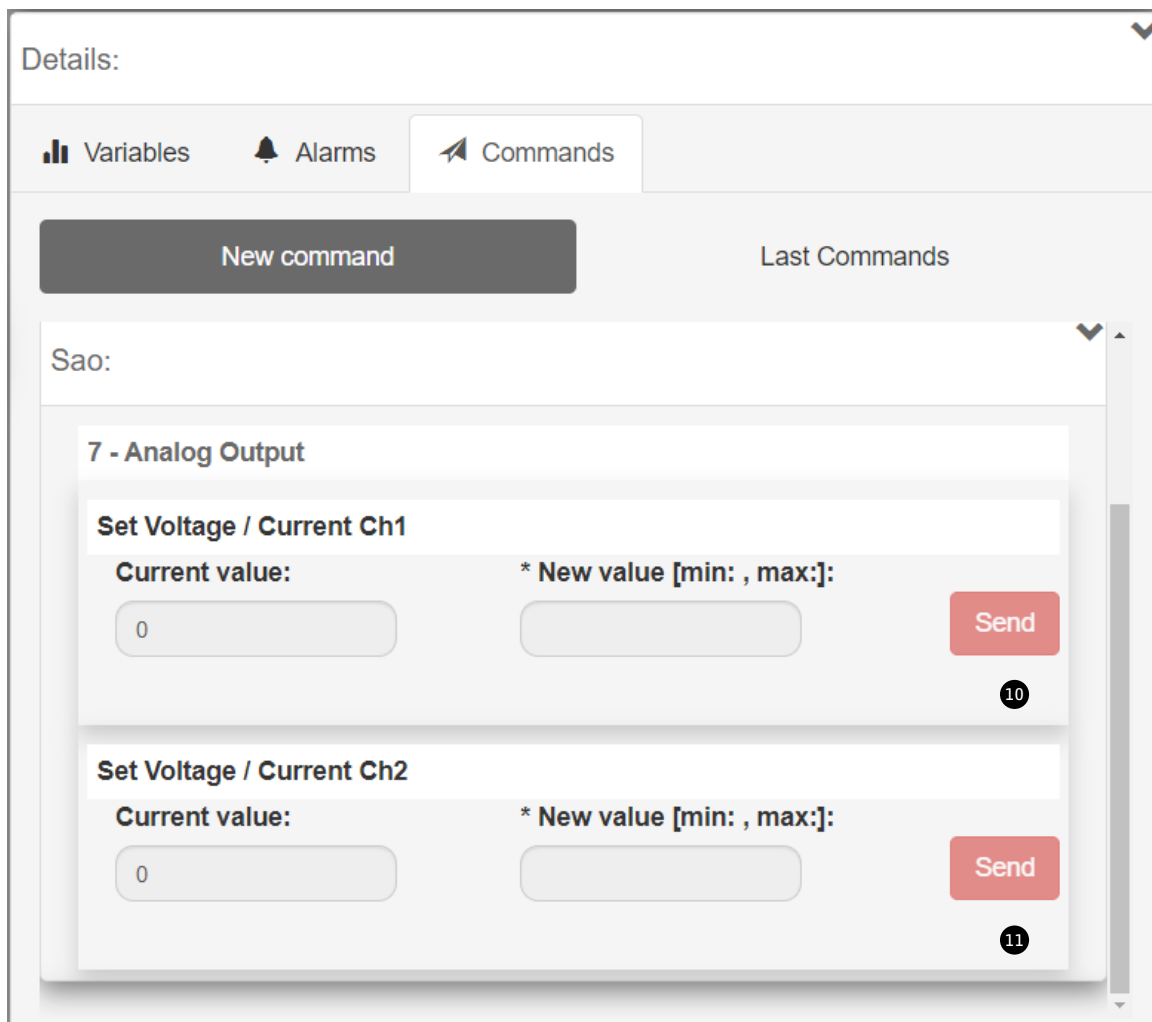

## 9.8 UVIX USB Gateway

The CX4 module can be connected to a PC via a USB cable. This connection - subject to prior installation of UVIX on the PC - allows you to communicate with the module through the Camozzi USB Gateway. For more information on using this tool, see the [UVIX Manual](#).

### 9.8.1 Main page

- ① Button to start up the USB Gateway and start communicating with the CX4 module.
- ② Button to stop communication with the CX4 module.
- ③ Button to access the UVIX Browser interface.
- ④ COM ports connecting the CX4 modules.
- ⑤ Virtual COM ports available and addresses of TCP connection for the connected COM ports.
- ⑥ Data received from the COM port.
- ⑦ Data received on the FEP of the UVIX system.

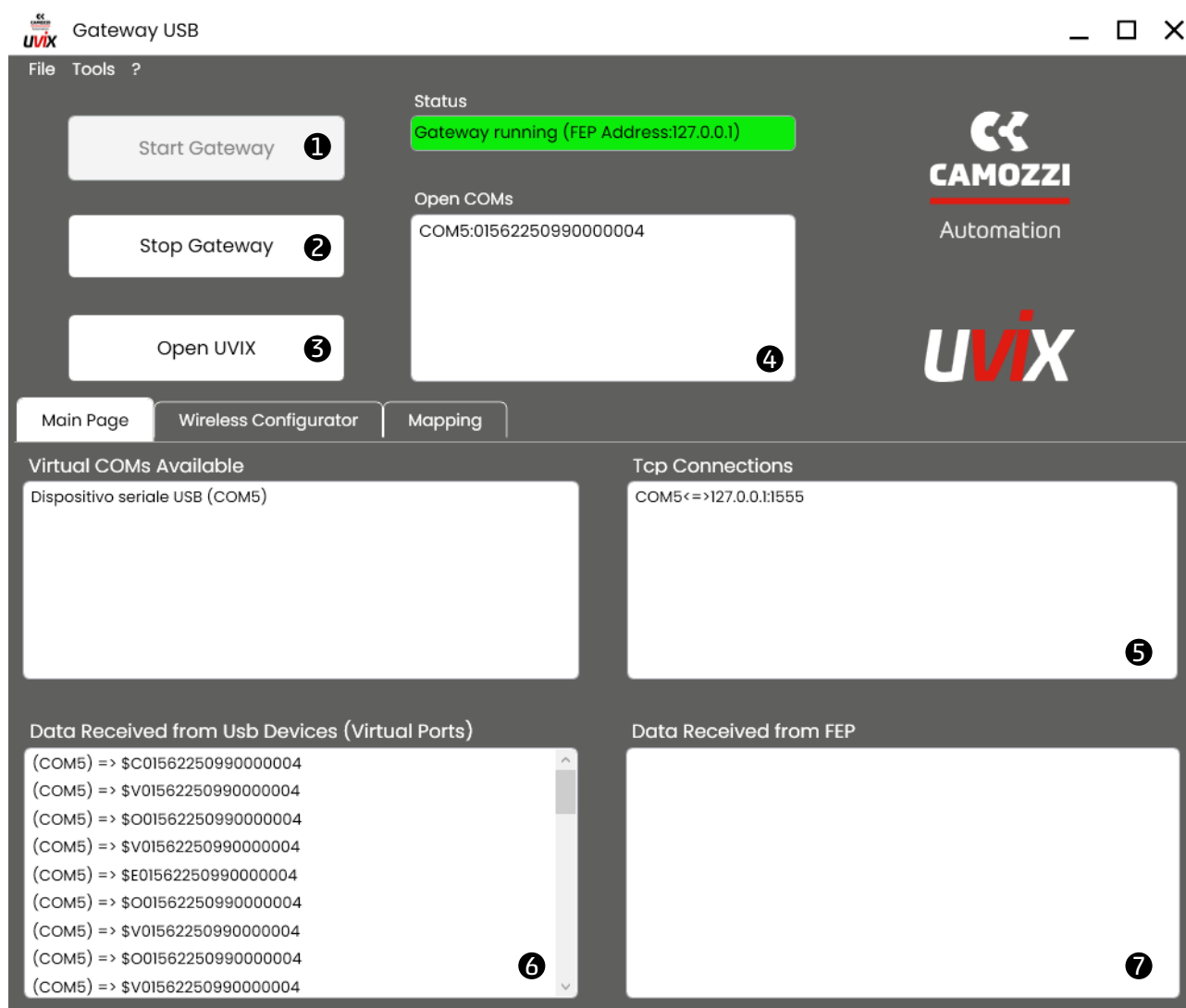

### 9.8.2 WiFi network configurator

In the tab for configuring the WiFi connection **8** (if available), you can read the parameters of the current connection and write any new ones for a new connection.

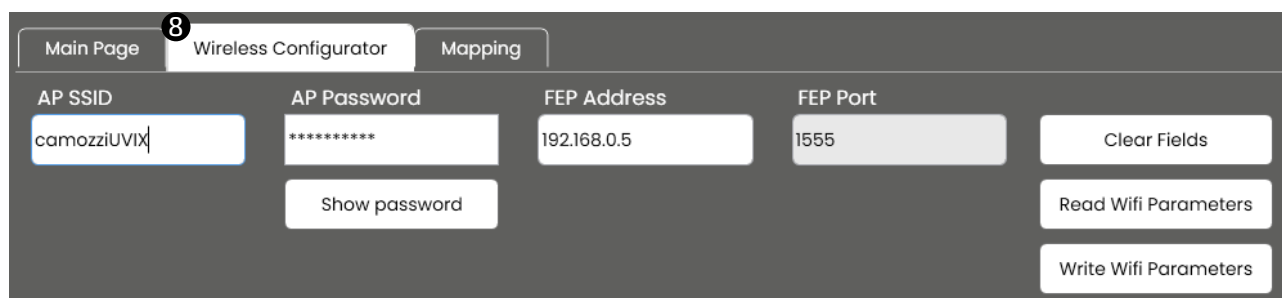

### 9.8.3 Mapping

In the last tab that can be consulted via the USB gateway, you can send a mapping request to the CX4 module. The *Require Mapping* button **9** remains pending until the next restart of the CX4 module.

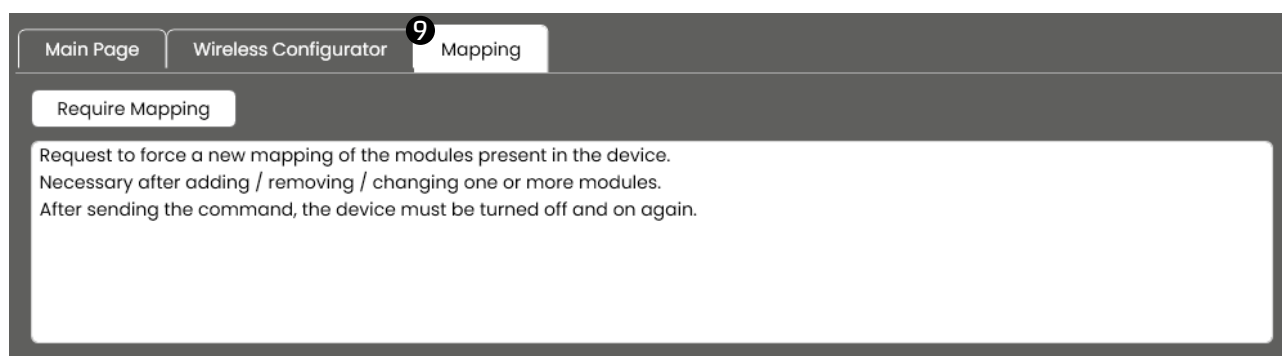

### 9.8.4 Firmware update

**⚠** Before carrying out this operation, you must contact Camozzi support.

The USB Gateway allows you to update the firmware of the CX4 module through the window found under *Tools* → *Device Upgrade* **10**.

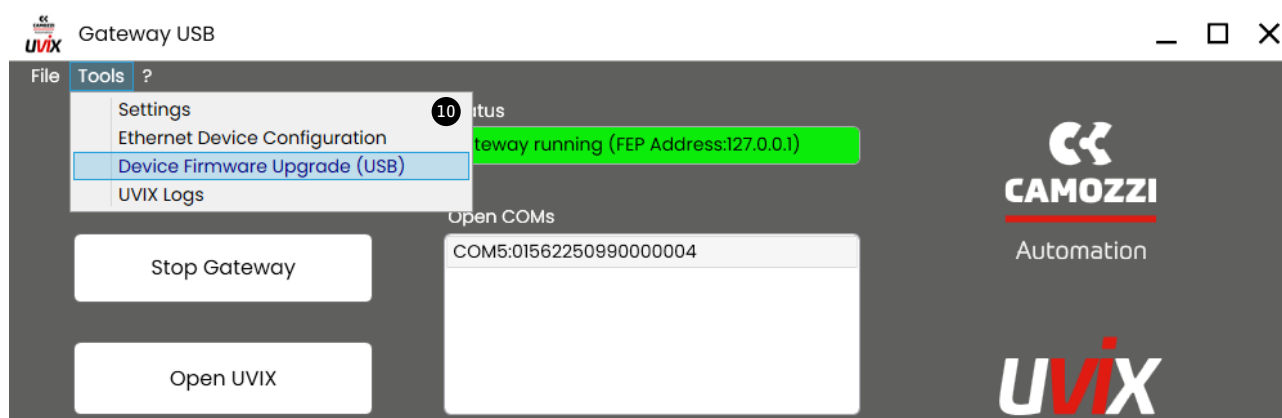

## Chapter 9 Uvix

The firmware update window indicates the current version **11** and allows you to select the new executable to upload to the module **12**. The name of the firmware executable to be loaded must have the following nomenclature:

- *CX4M*: indicates that the device is the CX4 master of the valve island.
- *xx*: indicates the fieldbus type, so PROFINET/IO → *PN*.
- *\_0136\_*: indicates the firmware version (in example the version is 01.36).
- *app.hex*: filename termination.

You must then put the device in *Boot mode* **13**.

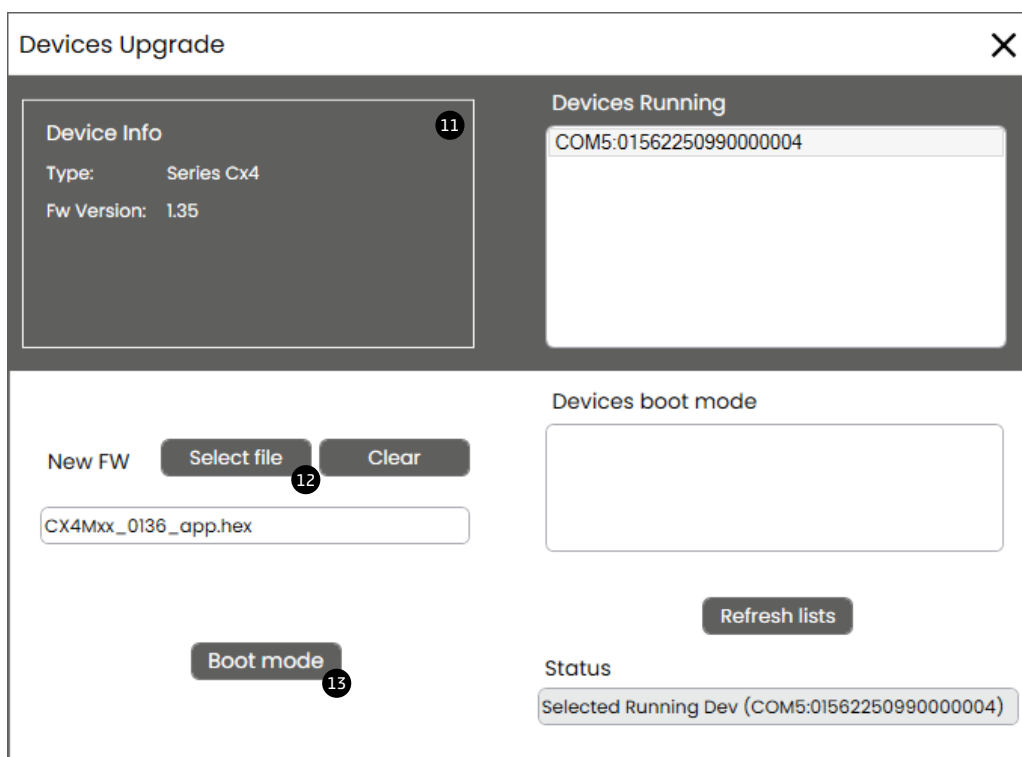



Once in Boot mode, the module is ready to load the new firmware into memory using the button **14**.

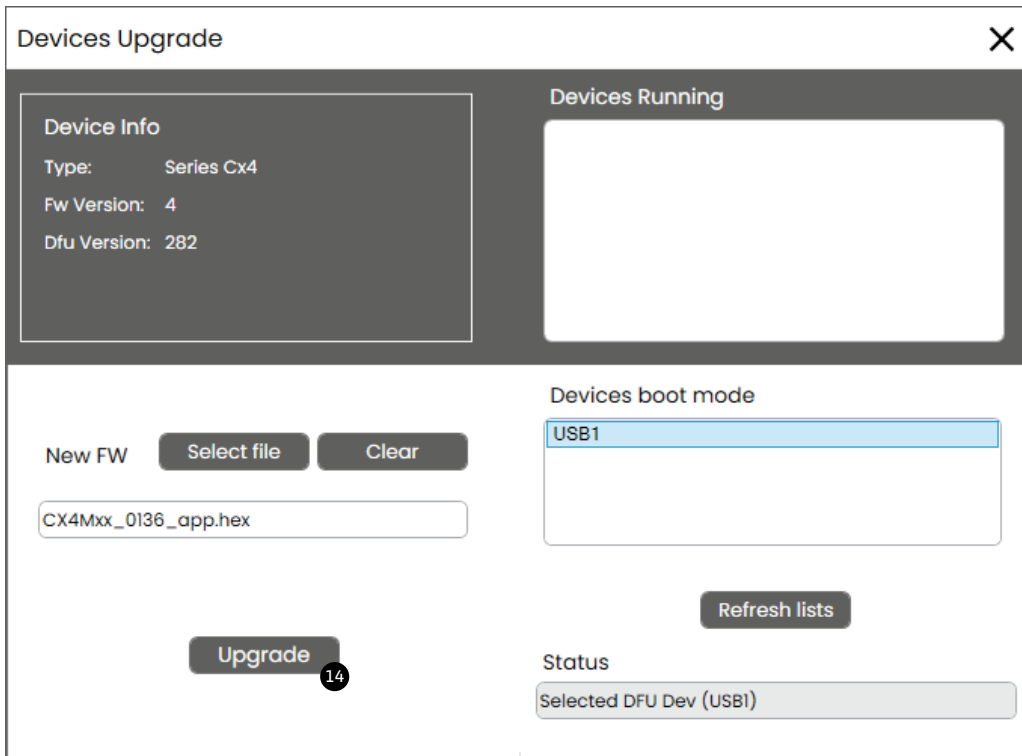

Wait for the new firmware to be loaded **15**.

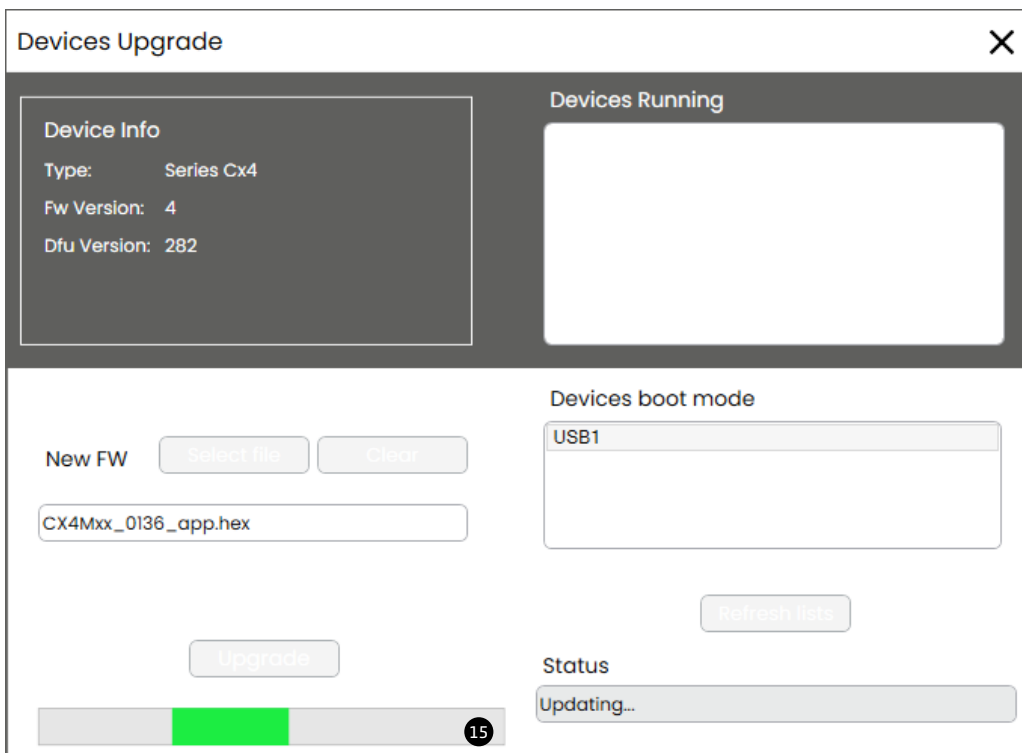

When the new firmware programming is completed, a confirmation window will be displayed <sup>16</sup>.

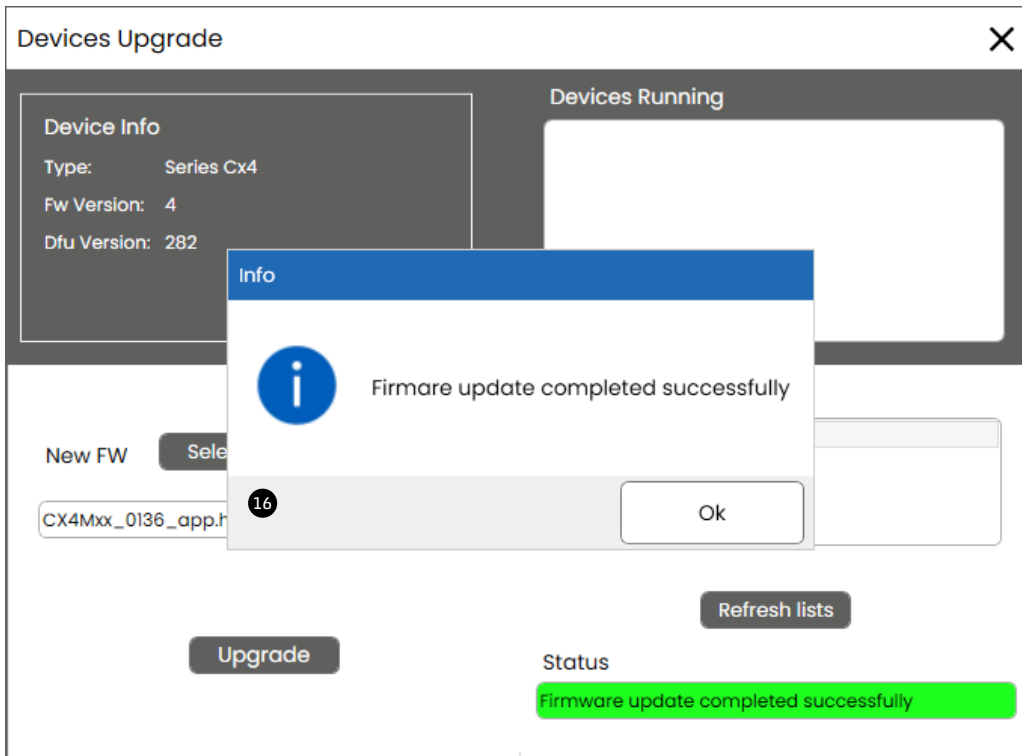

## 9.9 Communication with external applications

UVIX allows you to send managed variables to an external application that you create and customize to your needs. To configure this communication, refer to the [UVIX Manual](#).

If the communication is properly configured, the Web Service will publish a message every time it receives a variable from the valve island.

- **TS:** date and time of the sent message.
- **DevGr:** name of the device group to which the valve island belongs (e.g. *Packaging Machine*).
- **DevSerNum:** serial number of the device of 17 characters (es. 01302103990000035).
- **DevType:** device family. → Cx04.
- **DevName:** device name.
- **Slvld:** device ID.
  - 0 if is a variable of the CX4 master of the valve island.
  - >=1 if is a variable of the slave of the valve island.
- **SlvType:** slave family..

SlvType	Device
Cx04	Master of the valve island
Bis	Series D coil valves and subbase
Sdi	Digital Input Module
Sdo	Digital Output Module
Sai	Analogue Input Module
Sao	Analogue Output Module

- **SlvName:** slave name. If the variable is from the valve island master, the value will be Cx04.

- **VarId**: variable ID.

SlvType	VarId	Variables	Unit	Description
Cx04	1	Firmware version	xx.xx	CX4 master firmware version
	2	Temperature	°C	Internal temperature of the CX4 master
	3	Supply voltage	dV	Valve island power supply voltage
	4	Supply voltage (logic)	dV	Valve island logic supply voltage
Bis	1	Firmware version	xx.xx	Subbase firmware version
	2	Temperature subbase	°C	Internal temperature of the subbase
	3	Cycles coil 14	nr	Pilot activation cycles (14/12)
	4	Cycles coil 12		
	5	Health status coil 14	%	Pilot health status (14/12)
	6	Health status coil 12		
	7	Status coil 14	0 (OFF) 1 (ON)	Pilot activation status (14/12)
	8	Status coil 12		
	13	Temperature coil 14	°C	Pilot temperature (14/12)
	14	Temperature coil 12		
	15	Errors coil 14	nr	Pilot activation errors (14/12)
	16	Errors coil 12		
	17	Communication retries	nr	Failure to respond in communication on 485 protocol

SlvType	VarId	Variables	Unit	Description
Sdi	1	Firmware version	xx.xx	Firmware version of the digital input module
	2	Group 1-8	0bxxxxxxxx	Input bit mask 1-8
	3	Group 9-16	0bxxxxxxxx	Input bit mask 9-16
	4	Group 17-24	0bxxxxxxxx	Input bit mask 17-24
	5	Group 25-32	0bxxxxxxxx	Input bit mask 25-32
Sdo	1	Firmware version	xx.xx	Firmware version of the digital output module
	2	Group 1-8	0bxxxxxxxx	Output bit mask 1-8
	3	Group 9-16	0bxxxxxxxx	Output bit mask 9-16
Sai	1	Firmware version	xx.xx	Firmware version of the analogue input module
	2	Temperature channel 1	°C	Temperature measured on channel 1 for RTDs or Thermocouples
	3	Voltage channel 1	mV	Voltage measured on channel 1 for Bridge
	4	Voltage / Current channel 1	mV/mA	Voltage or current measured on channel 1 for general voltage or current inputs
	5	Temperature channel 2	°C	Temperature measured on channel 2 for RTDs or Thermocouples
	6	Voltage channel 2	mV	Voltage measured on channel 2 for Bridge
	7	Voltage / Current channel 2	mV/mA	Voltage or current measured on channel 2 for general voltage or current inputs

SlvType	VarId	Variables	Unit	Description
Sao	1	Firmware version	xx.xx	Firmware version of the analogue output module
	2	Channel 1	mV/mA	Voltage or current generated on channel 1
	3	Channel 2	mV/mA	Voltage or current generated on channel 2

- **VarVal:** Value of the variable represented with the format or units seen in the previous table.

### Esempi

Following are some examples of messages sent to external applications from a Series D valve island:

- Sending the logic supply voltage, which is 23.9 volts, of a Series D island called *Packaging Machine 1*.

```
"TS":"2020-04-07T09:10:25", "DevGr":"default group", "DevSerNum":"01302103990000035", "DevType":"Cx04", "DevName":"Packaging Machine 1", "SlvId":0, "SlvType":"Cx04", "SlvName":"Packaging Machine 1", "VarId":4, "VarVal":"239"
```

- Sending the number of activation cycles performed by the pilot in position 14 (equal to 1838 cycles) of a Series D solenoid valve (with no associated name) in position 3 in a Series D valve island named *Assembly Machine*.

```
"TS":"2022-01-28T15:21:05", "DevGr":"default group", "DevSerNum":"01302103990000121", "DevType":"Cx04", "DevName":"Assembly Machine", "SlvId":3, "SlvType":"Cx04", "SlvName":"Bis", "VarId":3, "VarVal":"1838"
```

- Sending the temperature (equal to 23 degrees centigrade) measured on channel 1 of an analog input (with no associated name) at position 10 in a Series D valve island named *Test Machine*.

```
"TS":"2023-10-01T11:59:55", "DevGr":"default group", "DevSerNum":"01302103990001002", "DevType":"Cx04", "DevName":"Test Machine", "SlvId":10, "SlvType":"Cx04", "SlvName":"Sai", "VarId":2, "VarVal":"23"
```

# NFCamApp

## 10.1 Main overview

NFCamApp is an app for smartphones (Android and iOS) which allows you to communicate - via NFC technology - with the CX4 module to obtain general information on the module and on the valve island (if configured as such). You can also use the app for module configuration.

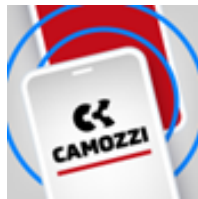

### 10.2 Main page

Once the CX4 module has been scanned, on the homepage, alongside the antenna positioned under the symbol , you can view the Camozzi series of the device **1** (*Series CX4*), assign a name to the device **2** and clone **3** the entire configuration (parameters of the CX4, the IO modules and the solenoid valve subbases) of the system, both in Stand Alone mode and as a Valve Island, to another system with a CX4 module compatible with the same fieldbus.

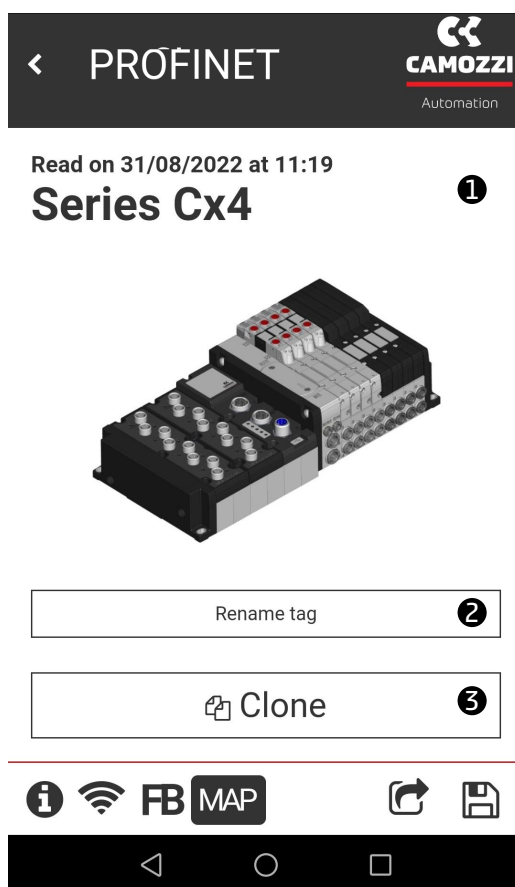

You can also access other pages of the app via the icons at the bottom of the homepage.

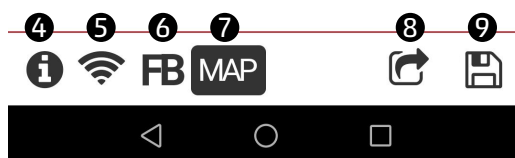

- **4** General module information page.
- **5** WiFi network information page (if available).
- **6** Bus information page.
- **7** Page to request new mapping.
- **8** Share module and/or island configuration.
- **9** Save the configuration of the scanned module or island.



## 10.3 General information

The first selectable page  displays general information about the scanned CX4 module.

- ① Device family: *Series CX4*.
- ② Subtype of the CX4 module family: *Stand-alone, D1, D2, D4 e D5*.
- ③ Firmware version.
- ④ Status of the WiFi connection: *Yes - WiFi module present, No - no WiFi module*.
- ⑤ Type of fieldbus: *PROFINET/IO*.
- ⑥ The serial number consists of 17 characters.
- ⑦ Version of the app.

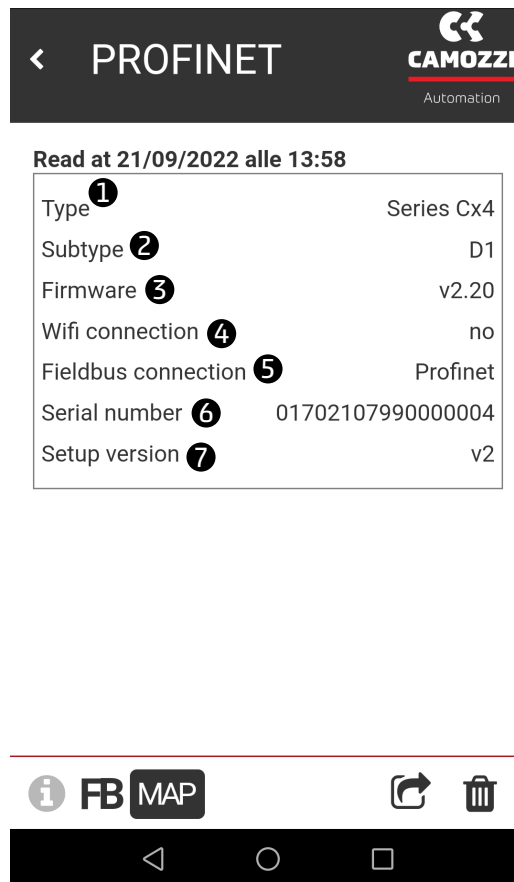

## 10.4 WiFi information

The WiFi connection information page  is found only if there is a WiFi module connected inside the CX4 module, otherwise it is not displayed.

- ❶ MAC address of the WiFi module.
- ❷ IP version of the WiFi connection.
- ❸ Name of the WiFi network to which the device is connected.
- ❹ WiFi network password.
- ❺ FEP address to which the devices are connected.
- ❻ FEP port to which the device is connected.
- ❼ Button for changing the data of the WiFi network to which you want to connect the module.

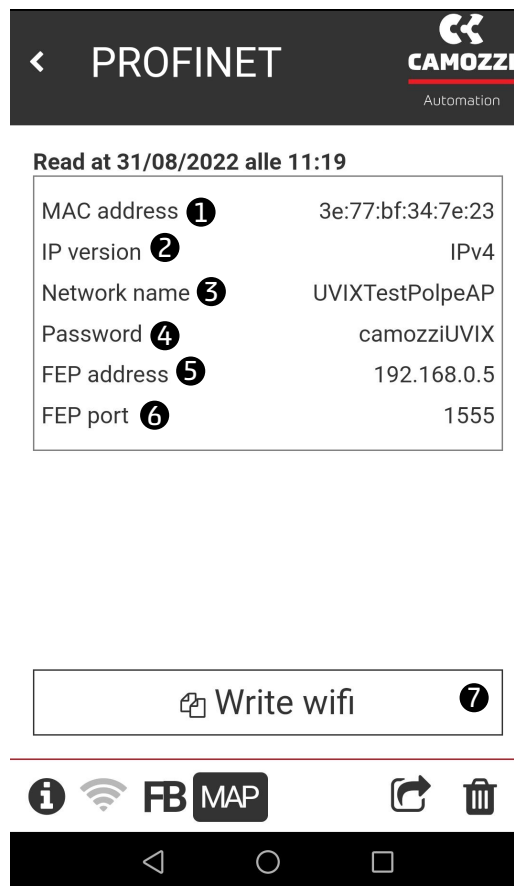

## 10.5 Fieldbus configuration

The PROFINET/IO protocol information page **FB** displays the name of the fieldbus **1** and also the name of the device on the network **2**, the IP address **3**, the mask **4** and the gateway **5** of the address. These parameters are configurable (par. 7.4) using the write button **6** and writing an NFC **7** through the app.

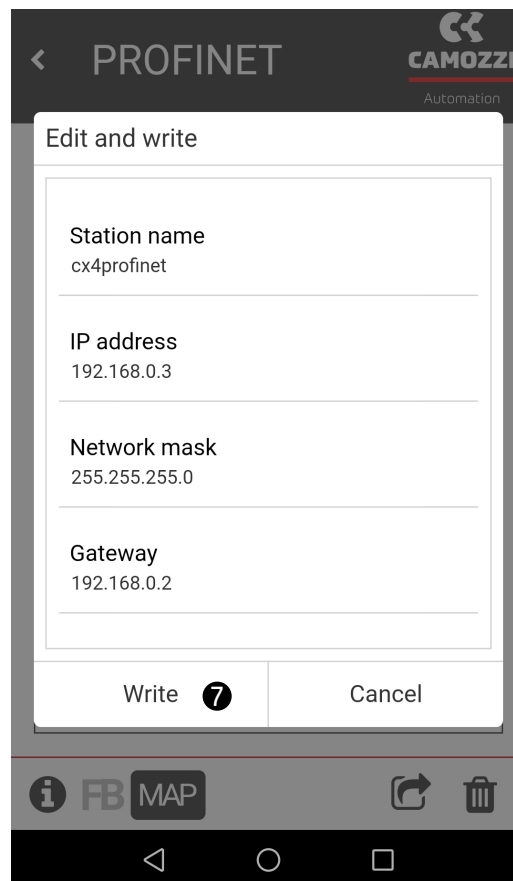
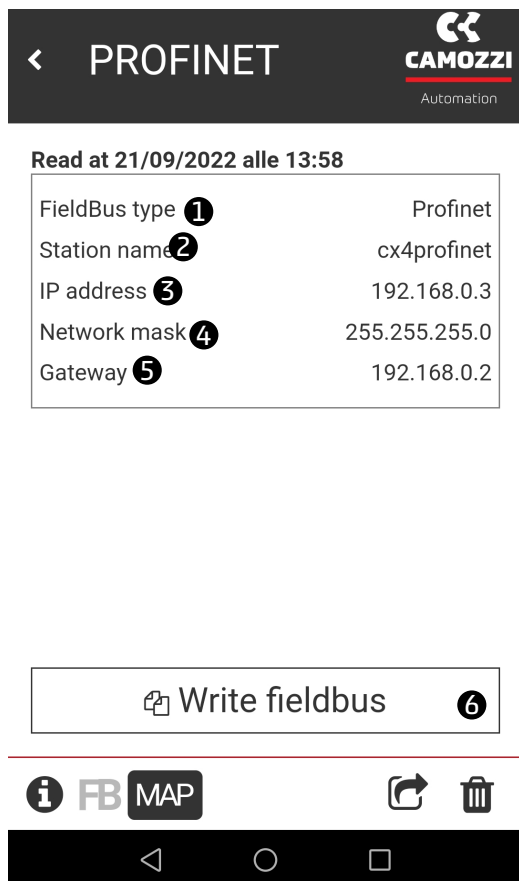

## 10.6 Mapping request

The last available page **MAP** in the app, you can request a new system mapping using the button *Require* **1**. Once the request has been made, it remains pending (the button will change to *Pending* **2**) until the next restart of the CX4 module.

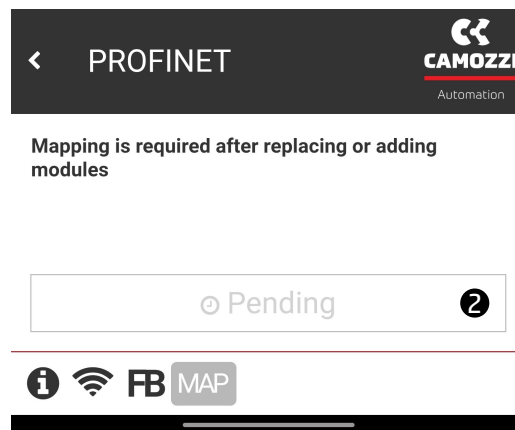
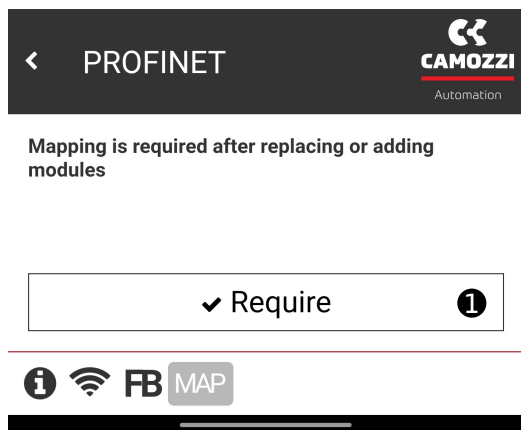

# Contacts

## Camozzi Automation SpA

Single-member company

Via Eritrea, 20/I

25126 Brescia - Italy

Tel. +39 030 37921

Fax +39 030 2400464

[info@camozzi.com](mailto:info@camozzi.com)

[www.camozzi.com](http://www.camozzi.com)

## Product Certification

National and International Directives, Regulations and Standards

[productcertification@camozzi.com](mailto:productcertification@camozzi.com)

## Technical assistance

Technical information

Product information

Special products

Tel.+39 030 3792390

[service.camozzi@camozzi](mailto:service.camozzi@camozzi)

## Contacts

### **Camozzi Automation S.p.A.**

#### **REGISTERED OFFICE:**

Via R. Rubattino, 81 - 20134 Milano (Italy)  
P.IVA IT 03207930177

#### **OPERATIONAL HEADQUARTERS:**

Via Eritrea, 20/I - 25126 Brescia (Italy)  
Tel. +39 03037921 | [Info@camozzi.com](mailto:Info@camozzi.com)  
[www.camozzi.com](http://www.camozzi.com)

#### **Technical assistance**

Tel. +39 030 3792790  
[service@camozzi.com](mailto:service@camozzi.com)

#### **Product certification**

Information concerning product certifications,  
EC standards, conformity declarations and instructions  
[productcertification@camozzi.com](mailto:productcertification@camozzi.com)



Automation

